



EURASIA Journal of Mathematics, Science and Technology Education

September, 2017

Volume: 13

Issue: 9

<http://www.ejmste.com>

e-ISSN: 1305-8223

ISSN: 1305-8215



<http://www.ejmste.com>



<https://twitter.com/ejmste>



<https://www.facebook.com/ejmste>



<http://modestum.co.uk/>



publications@modestum.co.uk



Editors-in-Chiefs

Chun-Yen CHANG, National Taiwan Normal University (NTNU), TAIWAN
Milan KUBIATKO, University of Zilina, SLOVAKIA

Editors

Len ANNETTA, *East Carolina University, USA*
Pierre COLLET, *University of Strasbourg, FRANCE*
Xiufeng LIU, *Graduate School of Education, University at Buffalo, USA*
Jing LIN, *Beijing Normal University, CHINA*
Silvija MARKIC, *University of Education Ludwigsburg, GERMANY*
Teen-Hang MEEN, *National Formosa University, TAIWAN*
Jan Alexis NIELSEN, *University of Copenhagen, DENMARK*
Tali TAL, *Technion - Israel Institute of Technology, ISRAEL*
Chunxia QI, *Beijing Normal University, CHINA*
Kwok Cheung CHEUNG, *University of Macau, MACAU*
Der-Ching YANG, *National Chiayi University, TAIWAN*

Assistant Editors

Jana FANCOVICOVA - *University of Trnava, SLOVAKIA*,
E-mail: fankaj@gmail.com
Vanda JANSTOVA - *Charles University, Prague, CZECH REPUBLIC*,
E-mail: vanda.janstova@natur.cuni.cz

Editorial Board

Fouad ABD-EL-KHALICK, *University of Illinois at Urbana-Champaign, USA*
Agustin ADÚRIZ-BRAVO, *Universidad de Buenos Aires, ARGENTINA*
Maria Pilar Jiménez ALEIXANDRE, *Universidade de Santiago de Compostela, SPAIN*
Michael ALLEN, *Kingston University, UK*
Kyriacos ATHANASIOU, *National and Kapodistrian University of Athens, GREECE*
Alipaşa AYAS, *Bilkent Üniversitesi, TURKEY*
Nélio BIZZO, *Universidade de São Paulo, BRAZIL*
Saouma BOUJAOUDE, *American University of Beirut, LEBANON*
Lynn A. BRYAN, *Purdue University, USA*

Peter C. CORMAS, *California University of Pennsylvania, USA*
Colleen T. DOWNS, *University of KwaZulu-Natal, SOUTH AFRICA*
Jan H. VAN DRIEL, *University of Melbourne, AUSTRALIA*
Ingo EILKS, *University of Bremen, GERMANY*
Lyn ENGLISH, *Queensland University of Technology, AUSTRALIA*
Olle ESKILSSON, *Kristianstad University, SWEDEN*
Uwe GELLERT, *Freie Berlin University, GERMANY*
Anjum HALAI, *Aga Khan University, PAKISTAN*
Gürol IRZİK, *Sabancı Üniversitesi, TURKEY*
Gert KADUNZ, *University of Klagenfurt, AUSTRIA*
Marika KAPANADZE, *Ilia State University, GEORGIA*
Gregory J. KELLY, *The Pennsylvania State University, USA*
Vanessa KIND, *Durham University, UK*
Vincentas LAMANAUSKAS, *University of Sialuliai, LITHUANIA*
Jari LAVONEN, *University of Helsinki, FINLAND*
Norman G. LEDERMAN, *Illinois Institute of Technology, USA*
Rachel MAMLOK-NAAMAN, *Weizmann Institute of Science, ISRAEL*
Sonya N. MARTIN, *Seoul National University, REPUBLIC OF KOREA*
Mansoor NIAZ, *Universidad de Oriente, VENEZUELA*
Pernilla NILSSON, *Halmstad University, SWEDEN*
Rolf V. OLSEN, *University of Oslo, NORWAY*
Kamisah OSMAN, *Universiti Kebangsaan Malaysia, MALAYSIA*
Paul PACE, *University of Malta, MALTA*
Pavol PROKOP, *Trnava University, SLOVAKIA*
Sarantos PSYCHARIS, *School of Pedagogical and Technological Education - ASPETE, GREECE*
Rohaida Mohd. SAAT, *University of Malaya, MALAYSIA*
Chieh-Jen SHIEH, *Huaqiao University, CHINA*
Kenneth TOBIN, *The Graduate Center of CUNY, USA*
Chin-Chung TSAI, *National Chiao Tung University, TAIWAN*
Lung Hsiang WONG, *Nanyang Technological University, SINGAPORE*



The Eurasia Journal of Mathematics, Science and Technology Education (EJMSTE) is an academic journal devoted to the publication and dissemination of research and position articles on all aspects of mathematics, science, engineering, health, medical education and technology education. All articles are reviewed by the members of the editorial board which consists of internationally respected educators, researchers, and practitioners.

Submissions: EJMSTE has a fully online review system. This system offers authors the convenience of submitting their manuscripts via **ScholarOne** and **EditorialSystem**. Please send your manuscripts as an MS Word attachment to the editors via the following addresses:
<https://mc04.manuscriptcentral.com/eurasia>
<https://www.editorialsystem.com/ejmste/>

Eurasia Journal of Mathematics, Science and Technology Education (EJMSTE) is a monthly journal published online 12 times annually in **January, February, March, April, May, June, July, August, September, October, November, and December**.

EJMSTE is indexed and/or abstracted in **Cabell's Directory Index, EBSCO, SSCI® - Social Science Citation Index, SCOPUS, ERIC - Education Resources Information Center, PsycINFO, Current Contents - Social & Behavioral Sciences, EdNA Online Database, Education Research Index, Google Scholar, Higher Education Teaching and Learning Journals, Higher Education Research Data Collection, Index Copernicus, JournalSeek, MathDi, TOC Premier Database, Ulrich's Periodicals Directory and ZDB - Zeitschriftendatenbank**.

Publication of any material submitted by authors does not necessarily mean that the journal, publisher, editors, or any of the editorial board members endorse or suggest the content. Publishing decisions are based and given only on scholarly evaluations. Apart from that, decisions and responsibility for adopting or using partly or in whole any of the methods, ideas or the like presented in EJMSTE pages solely depends on the readers' own judgment.

Published by: **MODESTUM LIMITED**
Publication Office: Suite 124 Challenge House
616 Mitcham Road, CRO 3AA, Croydon,
London, UK Phone: + 44 (0) 208 936 7681
Email: publications@modestum.co.uk
Publisher: <http://modestum.co.uk>
Journal Web: <http://www.ejmste.com>
Twitter: <https://twitter.com/ejmste>
Facebook: <https://www.facebook.com/ejmste>



Challenge House Business Centre

© 2005-2017. All rights reserved by Modestum Limited. Copyright for Open Access Content is Retained by Authors. Also, authors continue to hold the copyrights of their own papers by acknowledging that their papers are originally published in the EURASIA J Math, Sci & Tech Ed. Hence, articles published are licensed under a **"Creative Commons Attribution 4.0 International License."**

ISSN 1305 - 8223

VOLUME 13 ISSUE 9 CONTENTS (SEPTEMBER 2017)

Not Every Predatory Journal is Really Predatory Journal Milan Kubiátko https://doi.org/10.12973/eurasia.2017.00829a	6041–6043
A Path Analysis of Student Interest in STEM, with Specific Reference to Qatari Students Abdellatif Sellami, Rima Charbaji El-Kassem, Haneen Basheer Al-Qassass, Noof Abdulhadi Al-Rakeb https://doi.org/10.12973/eurasia.2017.00999a	6045–6067
Animals in Dangerous Postures Enhance Learning, but Decrease Willingness to Protect Animals Pavol Prokop, Jana Fančovičová https://doi.org/10.12973/eurasia.2017.01000a	6069–6077
The Effects of an Integrated Curriculum on Student Achievement in Saudi Arabia Amani K. H. Alghamdi https://doi.org/10.12973/eurasia.2017.01051a	6079–6100
Audit Knowledge and Accounting Conservatism: A Case of Executives' Vocational Learning and Application Bin Li, Muze Peng, Yingkui Zhang https://doi.org/10.12973/eurasia.2017.01043a	6101–6112
Exploring In- and Pre-Service Science and Mathematics Teachers' Technology, Pedagogy, and Content Knowledge (TPACK): What Next? Noha Alrwaished, Ali Alkandari, Fatimah Alhashem https://doi.org/10.12973/eurasia.2017.01053a	6113–6131
The Study of Consumer Green Education via the Internet of Things with Green Marketing Jui-Che Tu, Yu-Yin Chen, Shih-Chung Chen https://doi.org/10.12973/eurasia.2017.01054a	6133–6145
Scientific Disciplines of Geojunggi (the Traditional Crane) in Korean Science, Technology and History Class Pyoung Won Kim https://doi.org/10.12973/eurasia.2017.01055a	6147–6163
The Rise of MOOCs: The Literature Review of Research Progress and Hot Spots of MOOCs Education in Mainland China Ye Zheng, Ruo-Yu Yang https://doi.org/10.12973/eurasia.2017.01056a	6165–6174
The Effect of Preschool Mathematics Education in Development of Geometry Concepts in Children Sanja M. Maričić, Jelena D. Stamatović https://doi.org/10.12973/eurasia.2017.01057a	6175–6187
Analysis of Students Engagement and Learning Performance in a Social Community Supported Computer Programming Course Yu-Sheng Su, Ting-Jou Ding, Chin-Feng Lai https://doi.org/10.12973/eurasia.2017.01058a	6189–6201
Study on the Unsafe Acts and Education Function in Coal Mine Accidents Caused by Rescue Jiang Wei, Zhu Zhi-Ming, Xiang Yuan-Chi https://doi.org/10.12973/eurasia.2017.01059a	6203–6209
Mathematics, Technology and Learning: How to Align These Variables in Order to Explain Anxiety Towards Mathematics and Attitude Towards the Use of Technology for Learning Mathematics Lizzeth Navarro-Ibarra, Arturo García-Santillán, Omar Cuevas-Salazar, Julio Ansaldo-Leyva https://doi.org/10.12973/eurasia.2017.01060a	6211–6229

- A Preliminary Study on the Learning Satisfaction and Effectiveness of VR Weight Training Assisting Learning System for Beginners** 6231–6248
Peng-Wei Xiao, Kuo-Kuang Fan, Song Xu, Chung-Ho Su
<https://doi.org/10.12973/eurasia.2017.01061a>
- Curriculum Development for Enhancing the Imagination in the Technology Commercialization Process** 6249–6283
Chi-Yo Huang, Yu-Sheng Kao, Hsueh-Hsin Lu, Ming-Jenn Wu
<https://doi.org/10.12973/eurasia.2017.01062a>
- Application of Mediating Effect Test in Social Science Research: an Empirical Analysis of Geographic and Institutional Factors** 6285–6293
Qi Yue, Xing Hua, Luan Jiang
<https://doi.org/10.12973/eurasia.2017.01063a>
- A Study of the Performance Evaluation on E-Learning in Public Sectors** 6295–6301
Hong-Cheng Liu
<https://doi.org/10.12973/eurasia.2017.01064a>
- Corporate Governance, Professional Education, and Employee Bonus in High-Tech Industry-Evidence from Taiwan** 6303–6311
Lin Wen Hsiang
<https://doi.org/10.12973/eurasia.2017.01065a>
- How to Promote Knowledge Sharing among EVC Members? – Based on Interactive Perspective of Modified TAM Model** 6313–6323
Shi-Jian Wu, Guo-Xin Liu, Xin-Min Liu, Zhong-Bao Zhou
<https://doi.org/10.12973/eurasia.2017.01066a>
- A Study of the Hand Operating Thresholds during the Usage of an Electric Steam Iron by College Students** 6325–6335
Ya-Chuan Ko
<https://doi.org/10.12973/eurasia.2017.01067a>
- Research on College Students' Entrepreneurial Team Heterogeneity under the Background of Entrepreneurship Education** 6337–6346
Yonghui Cao, He Jiang
<https://doi.org/10.12973/eurasia.2017.01068a>
- Organizational Learning and Organization Innovation in the Tourist Hotels - An Empirical Study** 6347–6356
Hsin-Wei Fu
<https://doi.org/10.12973/eurasia.2017.01069a>
- Transformational Leadership Behavior of High-Level Sports Team Coaches and Athletes' Turnover Intention in China Universities: The Mediating Effect of the "Coach-Athlete Relationship"** 6357–6368
Yuan Wang, Ti Hu
<https://doi.org/10.12973/eurasia.2017.01070a>



OPEN ACCESS

EURASIA Journal of Mathematics Science and Technology Education
ISSN: 1305-8223 (online) 1305-8215 (print)
2017 13(9):6041-6043
DOI: 10.12973/eurasia.2017.00829a



Not Every Predatory Journal is Really Predatory Journal

Milan Kubiátko
University of Zilina, SLOVAKIA

Received 15 June 2017 • Revised 16 June 2017 • Accepted 17 June 2017

The academic world, I mean mainly publication activity, is influenced by many circumstances. Academicians are evaluated by the numbers of papers published in the journals through last year or more (it depends on country). In academic publishing, a paper is an academic work that is usually published in an academic journal. It contains original research results or reviews existing results. Such a paper, also called an article, will only be considered valid if it undergoes a process of peer review by one or more referees (who are academics in the same field) who check that the content of the paper is suitable for publication in the journal. A paper may undergo a series of reviews, revisions, and re-submissions before finally being accepted or rejected for publication. This process typically takes several months. Next, there is often a delay of many months (or in some subjects, over a year) before an accepted manuscript appears. This is particularly true for the most popular and high evaluated journals where the number of accepted articles often outnumbers the space for printing. Some journals, particularly newer ones, are now published in electronic form only. Paper journals are now generally made available in electronic form as well, both to individual subscribers, and to libraries (Ellison 2011).

From the publications are derived financial compensations and also other career. This situation is well known for every person and organization, which is connected with the academic world and some of them are trying to little bit misuse this situation and earn some many on academicians. In the academic world is existing one group of journals and publishing houses. The journals and publishing houses promise fast review process and rapid publishing for the adequate processing fee. These journals are called predatory journals. Many authors were trying to define this concept and bring new kinds of information about this topic (e.g. Beall 2015; Berger & Cirasella 2015). Jeffrey Beall is considered for the first, who mentioned this problem and it is possible to find on his web-site list of predatory journals, which is actualized every moment. To sum up, predatory journals are primarily fee-collecting operations—they exist for that purpose and only incidentally publish articles, generally without rigorous peer review, despite claims to the contrary. Other characteristics are: high manuscript acceptance rates or acceptance guarantees; the publisher sends you an un-solicited invitation to submit an article for publication; minimal (or non-existent) peer review process; little attention paid to digital preservation; not necessarily indexed in electronic databases; journals may be short lived; no archiving policy. As I wrote above, it is possible to find many characteristics of predatory journals.

However, to mark journal as predatory according the above mentioned criteria is little bit superficial. The attentive researcher could notice that this “war” against many journals could lead toward decreasing of research and the change of kinds of information could be more problematic. I do not want to write about persons, who are propagators of predatory journals and who fight very aggressive. I would like to write more about process and about some problematic points. The marking of journal as predatory in nearly all cases is based on the processing fee. But what about journals, whose asking money for the downloading of published article? Is it not predatory behavior? Only for the comparison, some open-access journal asked 300 € for the publishing the manuscript and any other journal asked 30 € from reader for the downloading the published article. If 50 readers download this article the profit will be 1500 € for the publishing house. As Berger & Cirasella (2015) wrote, charging a fee is not

© **Authors.** Terms and conditions of Creative Commons Attribution 4.0 International (CC BY 4.0) apply.

Correspondence: Milan Kubiátko, *University of Zilina, Faculty of Humanities, Department of Pedagogical Studies, Univerzitna 1, 01026 Zilina, Slovakia.*

✉ mkubiátko@gmail.com

itself a marker of a predatory publisher: many reputable open-access journals use processing fees to cover costs, especially in fields where research is often funded by grants (many subscription-based journals also charge authors fees, sometimes per page or illustration). The processing fee have got a justification, because in the majority of cases authors of publication does not pay from own financial sources, but from different funds or grants respectively faculty or university provided money for the processing fee. And if journal have not got string financial scaffolding from own university or from other source it is very problematic to secure the function of journal. However, it is possible to find many journals, which are included in the some world known databases (Web of Science, SCOPUS) and journals are belonging into some well-known publishing house and they have got processing publishing fees. Prestige journals typically charge several thousand dollars. Oxford University Press, with over 300 journals, has fees ranging from £1000-£2500, with discounts of 50 % to 100 % to authors from developing countries. Wiley Blackwell has 700 journals available, and they charge a flat \$US3000 open access fee. Springer, with over 2600 journals, charges US\$3000 or EUR 2200 (excluding VAT) (see web pages of journals or publishing houses).

Other fact, which is connecting with the growing of theories regarding to predatory journals, it is a growth in academic publishing in developing countries as they become more advanced in science and technology. Although the large majority of scientific output and academic documents are produced in developed countries, the rate of growth in these countries has stabilized and is much smaller than the growth rate in some of the developing countries. The fastest scientific output growth rate over the last two decades has been in the Middle East and Asia with Iran leading with an 11-fold increase followed by the Republic of Korea, Turkey, Cyprus, China, and Oman (Mortazavi & Hashemi 2011). And other interesting notice, there is a long history of subscription and print journals supplementing their subscription income by charging other kinds of publication fee (Curb & Abramson 2012), such as submission charges, as well as additional author-side fees including page and colour charges. King & Alvarado-Albertorio (2012) report on a study that showed that 50% of articles in 1977 had some form of author-side payment, although the practice declined somewhat in subsequent years as the financial costs of publication were shifted onto higher subscription fees.

The problem is in different place, many journals are added on the predatory list on the basis of information from authors, whose have got a suspicion about unfair behavior of journal. And many organizations add this journal on the list and send the e-mail to all employees of university, that these journals are not good, they are predatory and employees should not publish in these journals. And when some employee publish there, it is marked as "bad author" without any finding out about publishing process from "bad author". The authors of publications in "predatory journals" should be heard about the process of communication with editor, about reviewing process and about final process with the manuscript. So, the adding of journals in the any list of "predatory journals" and to pretend, that it is right way, it is not good and it can lead decreasing of science and to improving of fear from publication activity, because every journal has got the potential to be a bad journal.

On the basis of previous information, it seems, that the way to mark nearly any new journal as predatory is not well. It looks in some moments like witch hunt, where every author has got chance to be a witch. I think, every of us has got own brain and knows, where to publish results of research and every author has got a responsibility for own career and development of own personality. The judging of authors for their works is not correct way, it can lead to inactivity in the publication process. It is possible to find some information from the authors, whose the concept "predatory journals" deny and have got more reasonable solutions (e.g. Anderson 2015) So, to hunt the witches is not always the correct solution. The better way is to provide service for starting authors, how to write a scientific manuscript and how to send it into journal and all about the publication process.

REFERENCES

- Anderson, R. (2015). Should We Retire the Term "Predatory Publishing"? Retrieved on August 18, 2016 from <https://scholarlykitchen.sspnet.org/2015/05/11/should-we-retire-the-term-predatory-publishing>
- Beall, J. (2015). Predatory journals and the breakdown of research cultures. *Information Development*, 31(5), 473-476.
- Berger, M., & Cirasella, J. (2015). Beyond Beall's List. Better understanding predatory publishers. *College & Research Libraries News*, 76(3), 132-135.

- Curb, L. A., & Abramson, C. I. (2012). An examination of author-paid charges in science journals. *Comprehensive Psychology, 1*(4), 1-6.
- Ellison, G. (2011). Is peer review in decline? *Economic Inquiry, 49*(3), 635-657.
- King, D. W. & Alvarado-Albertoria, F. M. (2008). Pricing and other means of charging for scholarly journals: A literature review and commentary. *Learned Publishing, 21*(4), 248-272.
- Mortazavi, S. M. J., & Hashemi, Z. (2011). Tiger or rabbit does not matter: A new look into the recent great achievements of Iranian scientists. *Indian Journal of Science and Technology, 4*(6), 716-7166
- Cai, J. (2003). Singaporean students' mathematical thinking in problem solving and problem posing: An exploratory study. *International Journal of Mathematical Education in Science and Technology, 34*(5), 719-737. doi:10.1080/00207390310001595401

<http://www.ejmste.com>



For print copies of this issue or articles please send an e-mail to:

print@modestum.co.uk



OPEN ACCESS

EURASIA Journal of Mathematics Science and Technology Education
ISSN: 1305-8223 (online) 1305-8215 (print)
2017 13(9):6045-6067
DOI: 10.12973/eurasia.2017.00999a



A Path Analysis of Student Interest in STEM, with Specific Reference to Qatari Students

Abdellatif Sellami

Social and Economic Survey Research Institute (SESRI), Qatar University, Doha, Qatar

Rima Charbaji El-Kassem

Social and Economic Survey Research Institute (SESRI), Qatar University, Doha, Qatar

Haneen Basheer Al-Qassass

Social and Economic Survey Research Institute (SESRI), Qatar University, Doha, Qatar

Noof Abdulhadi Al-Rakeb

Social and Economic Survey Research Institute (SESRI), Qatar University, Doha, Qatar

Received 23 March 2017 • Revised 11 July 2017 • Accepted 14 August 2017

ABSTRACT

This study sought to explore the factors that help predict students' interest in Science, Technology, Engineering and Mathematics (STEM) in Qatar. Drawing on recent work in the field, the present paper examines the intersection of personal characteristics (gender and grade level) and contextual (teacher) variables, and their association with interest in STEM. The study involved a nation-wide survey of preparatory and secondary levels of education in Qatar implemented in 2015, and data from a sample of 660 preparatory (middle) and secondary (high) school students. Factor analysis extracted five valid dimensions and a path analytic model suggested that student interest in STEM is influenced by teachers, perceptions of homework assignments, self-confidence and intention to pursue further study. Gender and level of education were also identified as variables likely to affect student interest in a STEM field. The paper concludes with important recommendations for policy and suggestions for further study and research.

Keywords: causal model, interest in STEM, Qatar National Vision 2030, path analysis

INTRODUCTION

Science in its broadest sense is seen as a powerful means of understanding and solving the problems humanity is facing in the modern globalized world, including issues associated with climate change, health, immigration, natural resources, overpopulation, resource management, and so forth. It follows that STEM fields education is vital to our future and the future of the generations to come. With this being so, young people should be prepared to develop the skills and competencies needed to become the educators, innovators, researchers, and leaders in different STEM domains who can solve the most pressing problems facing humanity, now and in the future. However, a real challenge the modern world is currently confronted with is the dearth of people with the right STEM skill sets.

Without question, the need for qualified individuals will continue to grow rapidly in domains that require the necessary STEM knowledge and skills. Accordingly, a background and literacy in STEM have become essential

© **Authors.** Terms and conditions of Creative Commons Attribution 4.0 International (CC BY 4.0) apply.

Correspondence: Abdellatif Sellami, *Social and Economic Survey Research Institute (SESRI), Qatar University, Doha, Qatar, Tel: (+974) 4403-5761.*

✉ asellami@qu.edu.qa

State of the literature

- Personal interest is a major determinant of students' aspiration to and ultimately choice of a degree or occupation in a STEM field.
- Early interest in STEM influences future plans and eventual entry into a STEM field.
- Entering STEM majors in college for eventual employment in STEM fields is associated with both interest and proficiency in STEM.

Contribution of this paper to the literature

- Rather than making a contribution to the relevant theorization regarding interest in STEM, the focus of this study is to understand influences that bear upon students' interest in a STEM degree or profession.
- Because little is known about students' interest in and aspiration to a degree or career in STEM fields in Qatar and the Arab region by extension, this study tries to identify the factors likely to influence young Qataris' interest in STEM.
- The findings of this study can enhance our understanding of students' interest in STEM in a non-Western context.

for access to well-paid, high-status jobs (Greenwood et al., 2011). However, the disproportionate influence of STEM raises concerns that not enough STEM workers are being produced who can compete successfully in a global economy, while at the same time science educators in countries around the world struggle with keeping students active and interested in STEM (Boe et al., 2011; Mahoney, 2010; Gasiewski et al., 2012).

Referred to as STEM fields (science, technology, engineering, and mathematics) (Fouad et al., 2010; Goldman & Penner, 2014; Ing & Nylund-Gibson, 2013), policymakers and researchers have identified and grouped occupations they believe are key to global competitiveness and central to modern society. Concerns about shortages of qualified workers are especially salient in Qatar where a sharp deficit of STEM field skills is especially high (Jiwaji, 2014; Osman & Anouze, 2014). The system of education is often blamed for not being able to prepare citizens for the job market (Brewer et al., 2007; Gonzalez et al., 2008).

Many studies about children's interest in STEM degrees or professions have been conducted in North America and Western Europe (see for example Crisp, Nora & Taggart, 2009; Hilton & Lee, 1988). Yet, there are few places in the world with more need for STEM professionals than Qatar, a country that has abundant resources in oil and natural gas but a small citizen population with an even smaller subset trained in the occupations needed for sustaining the oil and gas industry. There is, therefore, a great need for a shift in strategy to redress the situation and counterbalance such paucity of skills required in STEM domains (Ministry of Development Planning and Statistics, 2015).

This study is both timely and needed to contribute to the efforts investigating the role that the school system as a whole can play in promoting and improving the quality of STEM education. The inspiration for our interest in this topic emanated from the realization that despite the great efforts exerted and the massive resources allocated by Qatar's leaders in an ongoing attempt to improve the quality of education, not enough attention has been paid to the ways and means of promoting the study of STEM. National reports underline the issue of Qataris having very low enrollments in programs that are "central to Qatar's economic development including science, mathematics and technology" (GSDP, 2012, p. 2). In the context of increasing concern regarding the shortage of citizens who have the critical skills and competencies needed for the knowledge economy, this study is timely and needed to investigate young Qataris' interest in STEM subjects.

Whereas expectations for Qatari students to perform at higher levels in STEM subject areas are very high, they are still lagging behind in international test scores on mathematics and science. Their performance in the Trends in International Mathematics and Science Study (TIMSS) and the Programme for International Student Assessment (PISA) – two major large-scale international assessments used to evaluate student performance in mathematics and science – is especially low. Results from TIMSS in 2007, 2011 and 2015 revealed poor test scores

achieved by Qatar's students (Bouhlila, 2011; Mullis et al., 2009; Mullis et al., 2016) and similar findings were concluded from PISA in 2006, 2009, 2012, and 2015 (Baldi et al., 2007; OECD, 2010, 2014, 2016).

If Qatar's system of education is to prepare a generation that is capable of meeting the demands of modern society and the highly competitive employment market, it is vital to focus more closely on developing the necessary STEM knowledge, skills and competencies. This is particularly so since the intent of the country's officials is to get young Qataris to be interested in STEM fields early in hopes of filling a future workforce void.

BACKGROUND

The State of Qatar has taken wide strides to develop its society into a regional hub of education and modernize its entire education system (GSDP, 2012). In 1998, discontent with the state of education in Qatar, the leadership commissioned the RAND corporation to assess the country's K-12 education system and design reform plans to enable it to be on a par with world-class standards and meet the evolving needs of Qatar (Brewer et al., 2007). In the *Qatar National Vision 2030* (GSDP, 2008), the State of Qatar detailed goals to move from a reliance on its hydrocarbon resources to a knowledge based economy by the year 2030; at the heart of these plans are the STEM fields.

Many studies highlight the marked lack of trained Qatari citizens in critical STEM fields (Abdulwahed et al., 2013; GSDP 2011; Shediak & Samman, 2010; Weber, 2014a, 2014b). At present, the demographic composition in Qatar demonstrates the country relies heavily on expatriate labor force with a very high national-foreign ratio (Berrebi et al., 2009; Ibnouf et al, 2014). The government of Qatar, as many places in neighboring Arab Gulf states, has responded to shortages in STEM fields by importing highly skilled workers from Europe, North America, South East Asia, and elsewhere. At the same time, educational reforms have resulted in greater emphasis on STEM education and training as fundamental assets for Qatar's future knowledge society (Barnett, 2015; Oxford Strategic Consulting, 2015, 2016; Wiseman et al., 2014).

The discrepancy between the skills graduates possess and the rising demand for skills in the labor market throughout the GCC countries (Shediak & Samman, 2010) suggests that the private sector in particular has had to rely on foreign workers for STEM occupations (De Bel-Air, 2014). For instance, as is pointed out by Berrebi, Martorell and Tanner (2009, p. 1), "the demand level for skilled and unskilled labor far outstrips that which Qatari nationals can provide." For many, not enough of Qatar's youth have access to quality STEM learning opportunities and too few students see STEM disciplines as springboards for their future careers (Rugh, 2002; Said, 2016, Said et al., 2016; Weber, 2014a, 2014b).

A significant contribution this study has for the existing body of scholarly knowledge consists in the relevance of its findings for educators and stakeholders in Qatar. Furthermore, the results concluded from it may inform educational policy in the country at a time when decision makers call for promoting STEM literacy that is much needed for Qatar in an increasingly science- and technology-driven world. Indeed, training and preparing literate citizens in various STEM disciplines has been a prime focus in the reform plans of many countries. Despite the substantial progress witnessed in most aspects of education infrastructure in Qatar, there is still a great need for improving STEM education as well as tackling the underachievement of students in STEM subjects at all levels of schooling.

The study can also be useful in contemplating how to increase the number of students who pursue degrees and careers in STEM fields. By examining factors that shape student interest in STEM fields, the study can provide insights into how to cultivate the skills and competencies necessary for effective STEM engagement in the post-compulsory years of schooling, and ultimately ensure students are well-prepared and suitably qualified to engage in STEM professions. Focusing on the school system is of crucial significance given the vital role that education plays in preparing citizens for the job market. More than ever before, the importance of STEM education is of central value in today's changing world.

LITERATURE REVIEW

Increasing global concern regarding the dearth of people who possess the critical skills and competencies needed for a sustainable knowledge economy has led to a feverish competition for finding the right people with the right skills in many countries worldwide. The hunt for talent has now taken immense dimensions (Beechler & Woodward, 2009; Carter, 2011; Michaels et al., 2001). In the United States, for example, ensuring sufficient numbers of graduates with the right skills in science, technology, engineering, and mathematics occupations has become a top priority for the nation (Chen & Soldner, 2013). Global concern regarding the paucity of people who possess the critical skills and competencies needed for a sustainable knowledge economy has led to a feverish competition for finding the right people with the right skills in many countries worldwide. The hunt for talent has now taken immense dimensions (Beechler & Woodward, 2009; Carter, 2011; Michaels et al., 2001) and gaps in STEM skills pipeline, especially at the secondary school and university levels, confirm the need to pique and nurture students' declining interest in STEM disciplines.

While research efforts in recent decades have helped broaden our understanding of what influences children's interest in STEM fields in Western contexts, it appears that published research that focuses on STEM and the factors that spark children's interest in STEM degrees or professions in Qatar is clearly lacking. Using survey-based quantitative data, this study sought to fill this gap and tap an area that remains of paramount importance to the future of the country and its sustainable development. This it did by providing an Arab, Middle Eastern perspective on students' interest in and aspirations for STEM degrees and careers.

Research on the factors that help predict children's interest in pursuing STEM subjects in secondary and tertiary education has largely focused on examining separate variables, including involving personal characteristics (academic achievement, motivation, self-esteem), social factors (parental influences, socio-economic status) and the future educational and career plans of young adolescents. This study looks at four different variables grouped together: impact of the teacher, perceptions of homework assignments, self-confidence and intention to pursue further study. With these variables brought together, the paper provides an informed perspective on the factors that shape Qatari students' interest in STEM degrees and professions. In particular, not enough is known about how students' perceptions of homework assignments impact their interest in STEM fields.

The literature on students' interest in STEM provides insights into factors that may be relevant to Qatar particularly since very little is known about young students' interest in STEM in the context of Qatar. The sections below provide a general overview of some of these factors, namely interest, self-confidence, the teacher, homework assignments, and intention to pursue further study.

Interest in STEM

Many studies have identified personal interest as a key factor in students' aspiration to and ultimately choice of a STEM degree or occupation (Beggs et al., 2008; Hall et al., 2011; Kuechler et al., 2009). Although an agreed on theoretical orientation towards the concept of interest does not exist (Renninger & Hidi, 2011), there is general consensus on the key aspects and characteristics of the concept of interest (Hasni & Potvin, 2015; Krapp & Prenzel, 2011). A substantial body of research confirms that the construct of interest has been used in various fields of study and research, such as education, psychology, sociology, etc. (Krapp & Prenzel, 2011). The present study mainly explores STEM situated within the domain of education (Hasni & Potvin, 2015).

The literature stresses the multidimensional definition of the interest concept that encompasses emotional, cognitive and other attributes (Hidi & Renninger 2006; Hidi et al., 2004; Schiefele, 2009). According to Krapp (2007) the construct of interest is "conceptualized as a relational concept: an interest represents or describes a more or less enduring specific relationship between a person and an object" (p. 8). Personal characteristics such as gender, grade level, country of origin, etc. are strongly associated with interest (Potvin & Hasni, 2014). Similarly, school-related variables (e.g. the teacher and teaching methods) and sociological factors (e.g. home background and parents' socioeconomic characteristics) are important predictors of interest (Hasni & Potvin, 2015; Krapp & Prenzel, 2011).

Recent research postulates that interest in STEM greatly influences student involvement in relevant science disciplines (Ainley et al., 2005; Ainley, 2012) and thus affects their aspiration to future careers associated with these fields of study (Baram-Tsabari & Yarden, 2009; Hasni & Potvin, 2015). To increase the number of individuals entering STEM majors in college for eventual employment in STEM fields, students must be both proficient and interested in STEM (BHEF, 2010). Research indicates that children's early interest in STEM is an indicator of the likelihood they would complete degrees in STEM (Becker & Park, 2011; Hayden et al., 2011; National Research Council, 2011). Using data from the National Education Longitudinal Study of 1988, Tai et al., (2006) found that roughly half of 8th graders in the study followed through with their plans and eventually achieved a degree in a STEM field, while far fewer students with non-STEM aspirations eventually switched into a STEM field.

Student Self-Confidence

Available research has shown that self-confidence in one's ability is associated with interest and achievement in STEM subjects (Ganley & Lubinski, 2016; Heaverlo, 2011). Used interchangeably with the concept of self-efficacy, self-confidence is a psychological construct used to measure an individual's belief in their own abilities and personal worth to execute a course of action, accomplish a specific goal or task such as studying, and bring about an outcome (Bandura, 1977; Bénabou & Tirole, 2002; Bong & Clark, 1999; Lee & Stankov, 2013; Morony, et al., 2013). This entails trust in oneself, believing in one's aptitude and capabilities (Bandura, 1997; Bong & Skaalvik, 2003). This study deals with self-confidence in isolation from the construct of self-efficacy.

Looking at the relationship between self-confidence and gender, Rittmayer & Beier (2008) report a gender gap pointing to differences in boys' and girls' beliefs in their math and science abilities. In their view, this gap is partly responsible for the shortage of women in science, technology, engineering, and mathematics (STEM) classes and careers (e.g., Eccles, 1994, p.1). Similarly, Sarsons and Xu (2015) contend that females display less of confident levels than males from a young age, which they say plays a key role in explaining differences in their academic success and career choices. Self-confidence has been shown to influence academic achievement and success (Bénabou & Tirole, 2002; Rittmayer & Beier, 2008; Tavani & Losh, 2003). According to Hill and colleagues (2010), for example, students who do not possess confidence in their math or science abilities are less likely to participate in fields that require those abilities and will give up in the face of difficulties, and females are specifically vulnerable in losing confidence in STEM fields.

Impact of the Teacher

The literature on STEM education stresses the impact of teachers on student interest in STEM fields (Cleveland et al., 2017; Griffith, 2010; Hill et al., 2005; Price, 2010; Watkins & Mazur, 2013). In their review of research involving student attitudes toward science, Osborne and colleagues (2003) concluded that science teachers play an important role in contributing to the prediction of student interest in science. According to Maltese and Tai (2010, p. 683), "teachers may be influential in turning students onto and also off from science." The role of teachers in promoting student love of science (Taylor et al., 2008) as well as their questioning, scientific inquiry, discovery and problem-solving cannot be underestimated (Dennen et al., 2007; Gormally et al., 2009; Marshall et al., 2009). Studies by Bettinger and Long (2005) indicated that instructors serve as role models and reported a positive association between instructors and students' course selection and choice of major.

Research has also shown that teachers greatly influence their students' educational achievement in STEM subjects (Blazar, 2016; Freeman et al., 2014; Sadler et al., 2013; Thompson, 2001). One of the reasons reported to lie behind poor student performance at school, especially regarding STEM subjects, is the inability of schools to sufficiently staff classrooms with qualified teachers, and this is mainly due to a shortage in STEM teachers (Ingersoll, et al., 2014). A report prepared by the Sutton Trust (2011) reveals that improving the quality of teachers can have a major impact on school performance, for teachers are the most significant element in schools that policy makers can focus on to enhance students' achievement. For example, with an effective math teacher, students can gain 40% more in their learning compared to a less effective one, and having an effective teacher improves the student achievement by a third at a GCSE grade (The Sutton Trust, 2011).

Perceptions of Homework Assignments

Homework assignments are an essential part of students' learning experience as recent research confirms. Many studies show that homework has a profound impact on learning outcomes as it aids in enhancing academic performance and achievement (Kitsantas & Zimmerman, 2009; Tyson et al., 2007; Zimmerman & Kitsantas, 2005). An added advantage of homework assignments is that they are positively associated with student achievement at school, as in the view of Trautwein (2007) and Trautwein and Köller (2003). Moreover, the literature reveals that homework provides possible remedies for different educational deficits students confront at school (Shapiro, 1996; Trautwein et al., 2002).

In general, the value of homework assignments lies in that they serve to attain different goals. More specifically, as Smolira (2008) argues, homework is useful in encouraging student learning, increasing their understanding of the material and enhancing their attention in class. Assigning schoolwork to students does not simply improve student academic achievement; it also helps to develop skills related to their responsibility, learning autonomy, and time management (Eaton et al., 2014; Warton, 2001), especially when students actively engage in assigned tasks (Cates & Skinner, 2000).

Intention to Pursue Further Study

In this study, the concept of intention is used to mean a person's intent, desire or aspiration to pursue post-secondary education (Anderson & Bourke, 2000). As is clear from the literature, students' intention to go after their educational aspirations depends on many factors, including personal, social and cultural influences (McDonough, 2004; Rock, 2010). An individual's personal characteristics, such as self-esteem, motivation, achievement and personal satisfaction, are closely associated with their intention to engage in further study (Anderson & Bourke, 2000). Additionally, there is a relationship between social factors, including family influences (finance and economic status, parental support), and student intention to continue post-secondary education (Bloom, 2007; Chen & Zimitat, 2006; Louie, 2007; Pimpa, 2003; St. John, 2002). Recommendations from family members, peers and friends have also been cited as important "push" factors that motivate student choice of future study (Mazzarol & Soutar (2002).

Other factors that influence one's intention to engage in further education include the worth that students place on education and the value they attach to it, as studies by Anderson & Bourke (2000) point to. More specifically, school-related factors such as school reputation, school climate, course availability have been found to shape young adolescents' plans to continue post-secondary studies (Forbes & Skamp, 2014; Price et al., 2003; Sjaastad, 2012). For example, McDonough (2004) attributes high school student transition to college to factors associated with the quality of the curriculum, college culture, especially regarding academic standards and communication related to college choice and transition, and the role of staff members in advising and counseling students as they prepare for transitioning to higher education.

RESEARCH PROBLEM/QUESTIONS

Lack of nationals armed with the skills and talents that are critical for the country's development and prosperity in a rapidly changing world is a real concern in Qatar (Jiwaji, 2014; Osman & Anouze, 2014) as the country braces to transition into a knowledge society, as outlined in the *QNV 2030* (GSDP, 2008). Central to this strategic goal is STEM education. The aim of this study was to identify the factors that influence preparatory and secondary Qatari students' interest in a degree or profession in a STEM field. For purposes of the study and drawing on previous research, we sought to decipher the relationship of the following four constructs to Qatari students' interest in STEM:

- a) Impact of the teacher,
- b) Perceptions of homework assignments,

- c) Self-confidence, and
- d) Intention to pursue further study.

As we tried to examine what motivates students to indicate interest in STEM, our aim was to see if there are any significant relationships between the participants' gender and level of education, and the variables discussed above. In carrying out this research, answers were solicited to the following questions:

- 1) What factors influence students' interest in STEM fields of study or work?
- 2) Are there any significant differences in students' responses with respect to their gender?
- 3) Are there any significant differences in students' responses with respect to their grade level?

We expect there to be significant relationships among students' personal characteristics (gender and grade level) and interest in STEM. The available literature on student interest in STEM subjects in general provides insights into the influences that may be relevant to the context of Qatar particularly since very little is known about this topic in this country and the neighboring states.

METHODOLOGY

Participants

For purposes of this study, which used a randomly stratified sample, we focused on data from the Qatari national students (n=660) in preparatory and secondary schools representing 38 independent and other schools in Qatar. Overall, the study involved 380 preparatory students (184 in grade 8 and 196 in grade 9) and an additional 280 secondary students (136 in grade 8 and 144 in grade 12). Students' average age is 13 for grade eight, 14 for grade nine, 16 for grade eleven, and 17 for grade twelve. Regarding gender, 57% of the student sample are female and 43% males. A weighting variable was created to take into account the selection probability and non-responses. With the above number of completions, the sampling error was calculated to be +/- 2 percentage points.

There are four predominant school types in Qatar that have emerged partially in response to the cleavage between citizens and immigrants but also because of a series of education reforms initiated in 2002 (GSDP, 2011; Stasz et al., 2007). These are: Independent (public) schools, international private schools, Arabic private schools and community schools that follow the curricula of particular countries.

Procedure

The data used in this study was gathered from students who participated in the 2015 Qatar Education Study (QES 2015) using survey questionnaires. The QES involved a nationally representative two-stage probability sample of Qatari students in grades 8 and 9 (preparatory schools) and grades 11 and 12 (secondary schools). The sampling frame for the QES 2015 was developed by SESRI using a comprehensive list of all public schools in Qatar supplied by the Ministry of Education and Higher Education. In Stage One, proportionate school sampling was used based on school type, school size, gender, and grade level. Stage Two involved random selection of one class from each school grade with all students in that class included in the study.

Forty-two schools were sampled for this study, with four schools refusing to participate. Classrooms were randomly chosen in 38 schools and all students in selected classrooms participated in the survey. The main challenge faced in using stratified random sampling for this study is associated with the time needed to go through the lengthy retrieval process prior to receiving the full list of the entire student population in the country from the Ministry of Education and Higher Education in Qatar.

This descriptive study utilized survey research conducted by the Social and Economic Survey Research Institute (SESRI) at Qatar University. Self-administered paper-and-pencil questionnaires were utilized to collect the data needed for this study. The questionnaires were distributed in class and highly trained SESRI researchers were

Table 1. KMO and Bartlett's Test

Kaiser-Meyer-Olkin Measure of Sampling Adequacy		.740
Bartlett's Test of Sphericity	Approx. Chi-Square	2296.050
	Df	120
	Sig.	.000

present in the classroom to oversee the process of questionnaire administration. Following approval from Qatar University's Internal Review Board, official letters requesting permission to implement the study were submitted to the relevant schools. Students and parents were informed about the goal of the research and were assured their responses would be strictly confidential; they were also told participation in the survey was voluntary. The questionnaires were administered after consent for the study was received.

Measures

Gender and grade level were used as control factors (test conditions) to check if there are any significant differences in student responses relative to interest in STEM.

Gender. This was used as a dichotomous variable (female=1, male=0). The gender distribution of respondents was almost even between female (49%) and male (51%).

Grade Level was obtained from the original list provided by the Ministry of Education and Higher Education (previously the Supreme Education Council). 8th and 9th grades were collapsed into preparatory school and 11th and 12th grades into secondary school. As is the case with gender, the distribution of students was divided nearly equally between preparatory (49%) and secondary (51%).

Establishing the Construct Validity and Reliability of the Instrument

The data were tested with regard to the appropriateness for component analysis, using the Kaiser-Meyer-Olkin (KMO) measure of sampling adequacy. KMO tests whether the data is sufficiently adequate and highly variable in order to conduct component analysis. The KMO should be greater than 0.5 for a satisfactory factor analysis to proceed. The KMO values range from 0 to 1, with values closer to 1 indicating high variability in the data. As such, values between 0.7 and 0.8 are good (Hutcheson & Sofroniou, 1999), which confirms that factor analysis is appropriate for our data.

The questionnaire designed for this research is composed of 69 dichotomous, open ended and closed scale items. Of these, 16 scaled items were measured using Likert scale in factor analysis. Two statistical tests were conducted in order to determine the suitability of factor analysis. First, the Kaisers-Meyer-Olkin (KMO) measure of sampling adequacy score of 0.740 was well above the recommended adequacy level of 0.50. Second, the Bartless test of sphericity was significant (Chi Square = 2296.050, P= 0.000), indicating that there are adequate inter-correlations between the 16 items which allow the use of factor analysis. Principal axis factoring was employed as an extraction method with oblique rotation method.

RESULTS & DISCUSSION

Five factors were extracted using the Eigen value greater than one criterion. The five-factor solution accounted for 62.163 per cent of the total variance. The five factors were easy to label (see **Tables 1, 2, and 3**).

Factor Analysis extracted five valid dimensions identified as reliable using Cronbach alpha, as is shown in **Table 2**.

Table 2. Total Variance Explained

Component	Initial Eigen values			Extraction Sums of Squared Loadings			Rotation Sums of Squared Loadings ^a
	Total	% of Variance	Cumulative %	Total	% of Variance	Cumulative %	Total
1	4.332	27.073	27.073	4.332	27.073	27.073	3.044
2	1.996	12.472	39.545	1.996	12.472	39.545	1.844
3	1.352	8.450	47.995	1.352	8.450	47.995	3.346
4	1.220	7.627	55.622	1.220	7.627	55.622	2.476
5	1.047	6.542	62.163	1.047	6.542	62.163	1.610
6	.956	5.974	68.138				
7	.900	5.626	73.764				
8	.811	5.070	78.833				
9	.649	4.053	82.887				
10	.557	3.483	86.369				
11	.543	3.391	89.760				
12	.404	2.528	92.288				
13	.375	2.344	94.632				
14	.304	1.902	96.534				
15	.290	1.812	98.346				
16	.265	1.654	100.000				

Extraction Method: Principal Component Analysis.

a. When components are correlated, sums of squared loadings cannot be added to obtain a total variance.

Table 3. Structure Matrix

	Component				
	1	2	3	4	5
Mathematics will be useful for my future	.779	-.056	-.342	-.211	.272
Science will be useful for my future	.732	.049	-.237	-.301	.038
I usually look forward to Science classes	.722	.083	-.348	-.321	-.088
I usually look forward to Mathematics classes	.702	.063	-.397	-.118	.145
I am often afraid of asking questions in Science classes	.004	.881	.036	.117	-.183
I am often afraid of asking questions in Mathematics classes	.004	.865	.139	.155	-.251
Teachers care about students	.379	-.048	-.828	-.276	.113
Teaching is good	.333	-.072	-.778	-.274	.172
Most of my teachers really listen to what I'm trying to say	.267	-.085	-.777	-.213	.090
When I work hard on schoolwork, my teachers praise my effort	.355	.028	-.776	-.235	.096
How would you rate the level of difficulty of homework assignments in science?	.140	-.243	-.220	-.759	-.064
How helpful do you find the assignments (science)?	.404	.192	-.322	-.706	.205
How helpful do you find the assignments (math)?	.451	.087	-.312	-.689	.335
How would you rate the level of difficulty of homework assignments math?	.188	-.328	-.307	-.597	.011
How likely is that you would go to college education after you leave secondary/high school?	.091	-.137	-.113	.013	.793
To what extent are you confident that you will graduate from secondary/high school?	.079	-.241	-.145	-.168	.750

Extraction Method: Principal Component Analysis.

Rotation Method: Oblimin with Kaiser Normalization.

Table 4. Cronbach Alpha (reliability test)

		Mean	St. Deviation	N	Cronbach's Alpha
Interest in STEM	Mathematics will be useful for my future	1.70	.974	613	.726
	I usually look forward to Science classes	1.71	.940	613	
	Science will be useful for my future	1.62	.960	613	
	I usually look forward to Mathematics classes	1.85	.943	613	
Student self - confidence	I am often afraid of asking questions in Science classes	3.10	1.059	623	.792
	I am often afraid of asking questions in Mathematics classes	3.04	1.050	623	
Impact of the teacher	Most of my teachers really listen to what I'm trying to say	1.93	.890	617	.821
	When I work hard on schoolwork, my teachers praise my effort	1.73	.835	617	
	Teachers care about students	1.82	.820	617	
	Teaching is good	1.79	.804	617	
Perception of homework assignments	How would you rate the level of difficulty of homework assignments in mathematics?	2.16	.808	570	.677
	How would you rate the level of difficulty of homework assignments in science?	2.15	.763	570	
	How helpful do you find the mathematics assignments?	1.67	.861	570	
	How helpful do you find the science assignments?	1.66	.842	570	
Intention to pursue further study	How likely is that you would go to college education after you leave secondary/high school?	1.33	.610	590	.506
	To what extent are you confident that you will graduate from secondary/high school?	1.38	.607	590	

- Factor one was labelled “interest in STEM” and is highly reliable, as shown by Cronbach’s alpha of 0.726;
- Factor two was labelled “student self-confidence” and is highly reliable, as shown by Cronbach’s alpha of 0.792;
- Factor three was labelled “impact of the teacher” and is highly reliable, as shown by Cronbach’s alpha of 0.821;
- Factor four was labelled “perception of homework assignments” and is highly reliable, as shown by Cronbach’s alpha of 0.677; and
- Factor five was labelled “intention to pursue further study” and is highly reliable, as shown by Cronbach’s alpha of 0.506.

Testing the Relative Importance of the Independent Variables to the Explained Variation in the Dependent Variable

The questionnaire used in this study has five valid dimensions that are reliable. In regressing the dependent variable interest in STEM on the other four dimensions (i.e. the independent variables), the results indicate that interest in STEM is determined by student self-confidence at 0.001 level of significance, impact of the teacher at 0.000 level of significance, perception of assignments at 0.000 level of significance and intention to pursue further study at 0.027 level of significance (see [Tables 5, 6, 7 and 8](#) below).

Table 5. Correlations

	Interest in STEM	Student self-confidence	Impact of the teacher	Perception of homework assignments	Intention to pursue further study
Pearson Correlation					
Interest in STEM	1.000	.077	-.408	-.305	.139
Student self-confidence	.077	1.000	.065	.109	-.127
Impact of the teacher	-.408	.065	1.000	.304	-.142
Perception of homework assignments	-.305	.109	.304	1.000	-.075
Intention to pursue further study	.139	-.127	-.142	-.075	1.000
Sig. (1-tailed)					
Interest in STEM	.	.047	.000	.000	.001
Student self- confidence	.047	.	.078	.009	.003
Impact of the teacher	.000	.078	.	.000	.001
Perception of homework assignments	.000	.009	.000	.	.052
Intention to pursue further study	.001	.003	.001	.052	.
N					
Interest in STEM	473	473	473	473	473
Student self- confidence	473	473	473	473	473
Impact of the teacher	473	473	473	473	473
Perception of homework assignments	473	473	473	473	473
Intention to pursue further study	473	473	473	473	473

Table 6. Model Summary

Model	R	R Square	Adjusted R Square	Std. Error of the Estimate
1	.475 ^a	.226	.219	.88362333

a. Predictors: (Constant), Intention to Pursue Further Study, Perception of homework assignments, student self- confidence, impact of the teacher

Table 7. ANOVA^a

Model		Sum of Squares	df	Mean Square	F	Sig.
1	Regression	106.590	4	26.648	34.129	.000 ^b
	Residual	365.410	468	.781		
	Total	472.000	472			

a. Dependent Variable: Interest in STEM

b. Predictors: (Constant), Intention to pursue further study, perception of homework assignments, student self-confidence, impact of the teacher

Table 8. Coefficients^a

Model	Unstandardized Coefficients		Standardized Coefficients	t	Sig.
	B	Std. Error	Beta		
(Constant)	1.071E-16	.041		.000	1.000
Student self-confidence	.134	.041	.134	3.246	.001
Impact of the teacher	-.340	.043	-.340	-7.901	.000
Perception of homework assignments	-.210	.043	-.210	-4.886	.000
Intention to pursue further Study	.092	.041	.092	2.224	.027

a. Dependent Variable: Interest in STEM

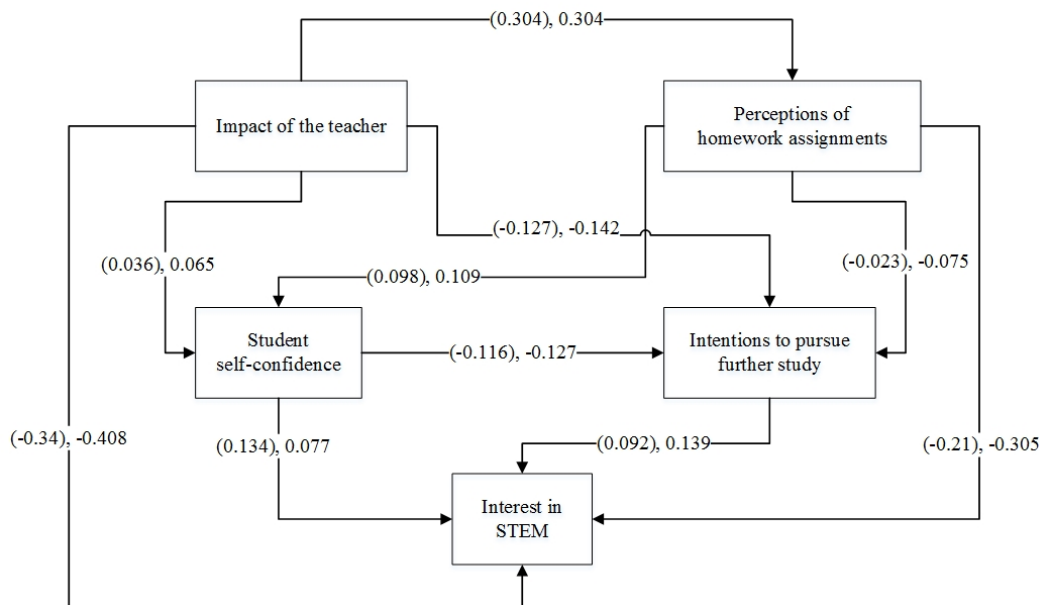

Figure 1. STEM predictors pathway analysis chart

Path Analysis: Calculation of Path Coefficients

Path analysis, as an extension of multiple regression, was employed to estimate the significance of the hypothesized causal connections between the variables chosen for this study (Land, 1969). Since our study is based on correlations, the prediction equation for interest in STEM in standardized scores is:

$$Z_y = \beta_1 Z_{x1} - \beta_2 Z_{x2} - \beta_3 Z_{x3} + \beta_4 Z_{x4}$$

$$Z_y = .134 Z_{x1} - .340 Z_{x2} - .210 Z_{x3} + .092 Z_{x4}$$

Based on logical basis, the researchers constructed the causal model shown in **Figure 1**. The correlation between parentheses is the magnitude of the true and direct effect between every two variables (known as path coefficients). As such, the correlation between the other values on each arrow, not in parentheses, represents the total effect (direct effect plus indirect effects). The casual model shows that the direct effect between student self-confidence and interest in STEM decreases because of the other intervening variables while the direct effect of each of the three predictors increases due to the effect of the other intervening variables.

Table 9. Coefficients (male)^a

Model	Unstandardized Coefficients		Standardized Coefficients	t	Sig.
	B	Std. Error	Beta		
(Constant)	-.086	.069		-1.243	.216
Student self-confidence	.176	.060	.199	2.962	.004
1 Impact of the teacher	-.356	.064	-.388	-5.592	.000
Perceptions of assignments	-.173	.066	-.181	-2.637	.009
Intention to pursue further study	.098	.064	.104	1.535	.127

a. Dependent Variable: Interest in STEM

Table 10. Coefficients (female)^a

Model	Unstandardized Coefficients		Standardized Coefficients	t	Sig.
	B	Std. Error	Beta		
(Constant)	.069	.052		1.324	.186
Student self-confidence	.072	.058	.065	1.245	.214
1 Impact of the teacher	-.305	.059	-.289	-5.167	.000
Perceptions of assignments	-.254	.057	-.247	-4.428	.000
Intention to pursue further study	.088	.054	.085	1.609	.109

a. Dependent Variable: Interest in STEM

The mathematical model below shows that the intervening variables (impact of the teacher, perception of homework assignments, and intention to pursue further study) led to a decrease in the direct effect between students' self-confidence and interest in STEM.

$$r_{53} = \frac{\sum Z_3 Z_5}{N} = \frac{1}{N} \sum Z_3 (Z_5)$$

$$r_{53} = \frac{1}{N} \sum Z_3 (P_{51}Z_1 + P_{52}Z_2 + P_{53}Z_3 + P_{45}Z_4)$$

$$r_{53} = P_{51}r_{13} + P_{52}r_{32} + P_{53} + P_{54}r_{34}$$

$$r_{53} = (-0.34)(0.065) + (-0.210)(0.109) + (0.134) + (0.139)(-0.127)$$

Introducing Gender and Grade Level as Test Factors (i.e. Conditions)

1. Gender as a predictor of interest in STEM

The results show that if gender is taken as a control factor and the analysis is repeated only for Qatari male students, intention to pursue further study is ruled out and interest in STEM is significantly predicted by impact of the teacher (0.000), student self-confidence (0.004) and perceptions of homework assignments (0.009) (Table 9).

Additionally, as Table 10 demonstrates, if gender is used as a control factor and the analysis is repeated only for female Qatari students, then interest in STEM is significantly determined by two variables only, namely impact of the teacher (0.000) and perceptions of homework assignments (0.000).

2. Grade level as a predictor of interest in STEM

The results also indicate that if grade is used as a control factor and the analysis is repeated only for Qatari preparatory school students (grades 8 and 9), the results are highly significant. As Table 11 shows, interest in STEM is significantly determined by the four variables of student self-confidence (0.009), impact of the teacher (0.000), perceptions of homework assignments (0.000) and intention to pursue further study (0.019).

Table 11. Coefficients (grades 8 & 9)^a

Model	Unstandardized Coefficients		Standardized Coefficients	t	Sig.
	B	Std. Error	Beta		
(Constant)	.001	.054		.020	.984
Student self-confidence	.136	.052	.143	2.621	.009
1 Impact of the teacher	-.297	.056	-.302	-5.327	.000
Perceptions of assignments	-.217	.055	-.222	-3.921	.000
Intention to pursue further study	.129	.055	.129	2.362	.019

a. Dependent Variable: Interest in STEM

Table 12. Coefficients (Grades 11 and 12)^a

Model	Unstandardized Coefficients		Standardized Coefficients	t	Sig.
	B	Std. Error	Beta		
(Constant)	.001	.054		.020	.984
Student self-confidence	.136	.052	.143	2.621	.009
1 Impact of the teacher	-.297	.056	-.302	-5.327	.000
Perceptions of assignments	-.217	.055	-.222	-3.921	.000
Intention to pursue further study	.129	.055	.129	2.362	.019

a. Dependent Variable: Interest in STEM

Moreover, if grade is used as a control factor and the analysis is repeated only for secondary Qatari students (grades 11 and 12), interest in STEM is significantly determined by the two variables only impact of the teacher (0.000) and perception of homework assignment (0.004). A difference exists and grade level is significant in explaining and predicting variation in STEM (Table 12).

This study focused on the factors that predict students' interest in a STEM degree or profession. Overall, four main influences were identified in this research: the teacher, perceptions of homework assignments, self-confidence and intention to pursue further study in a STEM degree or profession. The results reveal that these four influences intersect with both gender and grade level, and these findings are consistent with other studies that have shown that these factors shape student interest in STEM fields.

Based on the findings from this study, interest in STEM appears to be significantly predicted by the impact of the teacher for both male and female Qatari students in preparatory and secondary schools. This is consistent with results from other research showing that teacher demographics influence children's interest in STEM and whether young adolescents major in STEM fields (Maltese & Tai, 2010; Stearns et al., 2016). Teacher influences range from helping students improve self-confidence and academic performance to optimizing student exposure to math and science courses (Wang, 2013).

This study further reveals that the results regarding homework assignments are highly significant for Qatari students - boys and girls alike - at preparatory and secondary schools. Evidence from existing literature confirms the value of using coursework in general to improve and deepen students' knowledge and understanding of subject matter (Slapcoff et al., 2011). More specifically, the student data may be indicative of how homework assignments are viewed as appropriate vehicles for enhancing young people's interest in STEM subjects. Assignments are effective tools in motivating students to read materials prior to class, enable attentive classroom discussions, and offer valuable opportunities for working on challenging material and potential solutions to problems (Etlinger, 2014).

The data appear to suggest that self-confidence is an important predictor of student interest in STEM, especially as it intersects with the gender and grade level factors. Stated differently, students' self-confidence is

associated with their intent and motivation to engage in a STEM degree or occupation (Rittmayer & Beier, 2008). The results of this study confirm a gender gap associated with self-confidence that affects interest in STEM where male, but not by female, Qatari students' self-confidence helps to predict their interest in fields. Females' underrepresentation in STEM fields has been ascribed to their preference of jobs that are people-oriented rather than less things-oriented ones because women generally tend to choose careers that allow them to use their communication and social skills and abilities (Su & Rounds, 2015).

The present study also shows that self-confidence intersects with grade level in predicting interest in STEM. It is clear that in the case of students in lower levels of educations (only grades 8 and 9 in this study) self-confidence is a predictor of interest and eventual entrance into a STEM degree or profession in STEM. There is evidence that confirms a child's level of education plays an important role in a child's interest in STEM (Maltese & Tai, 2011). This shows a pipeline for the STEM workforce should start early in life, and strong links have been observed between early interest in STEM and eventual STEM professions (Tai, et al., 2006).

This study further suggests that intent to pursue further study is significantly predicted by grade level. This pertains specifically to Qatari students in lower (preparatory) levels of education (i.e. grades 8 and 9). This is in agreement with findings concluded from other research which indicates that children's early interest in STEM is an indicator of the likelihood they would complete a college degree in STEM (Becker & Park, 2011; Hayden et al., 2011). This points to the importance of promoting student interest in STEM at the early stages of education. Student intention to pursue post-secondary study as a predictor of student intent to continue post-secondary studies in STEM can be attributed to possible support from family members, peers and friends or school-related factors (school reputation, school climate, etc.), as evidence by available research (Forbes & Skamp, 2014; Price et al., 2003; Sjaastad, 2012).

LIMITATIONS OF THE STUDY

One limitation of this study is that it relied on utilizing a survey research questionnaire administered over a four-week period to examine different aspects of schooling, one of which is student interest in STEM. While this study tried to explore preparatory and secondary school students' interest in STEM in Qatar, it would benefit from using a survey that taps different developmental stages of student interest in STEM fields. Hence, replicating this study using longitudinal data is highly recommended. Another limitation of this research has to do with the focus of our research that is limited to discussing STEM as an object of interest within the school context. With this being the case, a line needs to be drawn between the way STEM subjects are perceived in society as well, that is outside the school setting.

RECOMMENDATIONS

To meaningfully engage students and at the same time raise achievement in the STEM fields for all K-12 students, there is need to foster high-quality teaching with world-class curricula, standards, and assessments of student learning that align with Qatari student needs and abilities. To attain this goal, a possible option to consider would be curriculum materials that can be modeled on world-class standards, including the introduction of new methods of teaching and learning as well as the use of digital technologies that enhance STEM education.

A hands-on approach to teaching and learning STEM subjects that increases student achievement in STEM fields needs to encourage real engagement with fundamental science concepts and principles should also be enhanced through application to real-life situations and practical work. Practical laboratory experience for both middle school and high school students in particular is of crucial value. In parallel with this, inquiry-based learning must be emphasized at all K-12 levels of schooling and individualized and group experiences using project based learning inside and outside the classroom through experiences such as science fairs, robotics contests and STEM Olympiads.

To ensure excellence in STEM education, there is urgent need for STEM teachers who possess deep content knowledge in STEM subjects along with good mastery of the pedagogical skills required for teaching these subjects

well. Support for STEM teachers should be provided so that they are ready to meet the challenges of teaching in the STEM classroom; particular emphasis must be placed on provision of ongoing quality professional development and the necessary resources to effectively teach at all levels.

Last but not least, career guidance should be available especially at the secondary school level to help adolescents become aware of potential STEM careers and connect their future career decisions to their educational decisions. Counselling programs can be useful in enhancing student engagement in STEM fields and promoting STEM careers while assisting students to make a smooth transition into college. Preparing students for this transition begins both in the classroom and through guidance programs, and counselors hold key roles in stimulating interest and encouraging young adolescents' exploration of career options in STEM fields.

CONCLUSION

Science, technology, engineering, and mathematics (STEM) are closely tied to the economic success and prosperity of Qatar and are vital to Qatar's transition to the knowledge economy and competitiveness. Strong STEM skills are a key element of a well-rounded education. Yet, strikingly few Qatari students seek or obtain a STEM bachelor's degree. As is reported in the Qatar University Book of Trends 2017, student interest in STEM is increasingly recognized as a critical key to increasing the number of students who graduate with a degree in a STEM field or aspire to a STEM career (Qatar University, 2017).

The dearth of Qatari graduates in STEM subjects adds another dimension to the challenge and complexity of attracting and retaining students in STEM domains. This speaks to the policy and decision makers particularly since Qatar is investing hefty amounts of money in a strenuous attempt to move from reliance on hydrocarbon resources and make a smooth transition to a society based on the knowledge economy.

In line with the Qatari National Vision 2030, findings of this research can be utilized to inform decision and policy makers as well as educators in Qatar in designing programs that promote, support and encourage students' interest in STEM. Given the findings of this study, more work is needed to promote STEM fields and trigger children's interest and engagement in STEM subjects at Qatari schools.

The focus of our research is limited to discussing STEM as an object of interest within the school context. With this being the case, it would also be useful to investigate the way STEM fields are perceived in society as well, that is outside school setting.

ACKNOWLEDGEMENTS

This work was supported by the Social and Economic Survey Research Institute, Qatar University. The authors would like to thank all the students and parents who took part in the 2015 Qatar Education Study. The authors would also like to thank Dr. Abdoulaye Diop, Dr. Elmogeira Elawad, and Mr. Isam Mohamed Abdelhameed in giving so generously of their time at various stages of the data collection and entry.

REFERENCES

- Abdulwahed, M., Ghani, S., Hasna, M. O., & Hamouda, A. (2013). Life is engineering program: Impact of an engineering outreach project in K-12. *2013 IEEE Global Engineering Education Conference (EDUCON)*. Technische Universitat Berling, Berlin Germany, 827-833. doi:10.1109/educon.2013.6530202
- Ainley, M. (2012). Students' interest and engagement in classroom activities. In S. L. Christenson, A. L. Reschly, and C. Wylie (Eds.). *Handbook of Research on Student Engagement*, 283-302. New York, NY: Springer.
- Ainley, M., Hidi, S., & Berndorff, D. (2002). Interest, learning, and the psychological processes that mediate their relationship. *Journal of Educational Psychology*, 94(3), 545.
- Anderson, L. W., & Bourke, S. F. (2000). *Assessing affective characteristics in the schools*. London: Routledge.
- Baldi, S., Jin, Y., Skemer, M., Green, P. J., & Herget, D. (2007). Highlights from PISA 2006: Performance of U.S. 15-Year-Old Students in Science and Mathematics Literacy in an International Context. *National Center for*

- Education Statistics, Institute of Education Sciences, U.S. Department of Education.* Washington, DC. Retrieved from: https://nces.ed.gov/pubs2008/2008016_1.pdf
- Bandura, A. (1977). Self-efficacy: Toward a unifying theory of behavioral change. *Psychological Review*, 84(2), 191-215.
- Bandura, A. (1997). *Self-efficacy: The exercise of control*. New York: Freeman.
- Baram-Tsabari, A., & Yarden, A. (2009). Identifying meta-clusters of students' interest in science and their change with age. *Journal of Research in Science Teaching*, 46(9), 999-1022.
- Barnett, C. (2015). *Human capital and the future of the Gulf*. Centre for Strategic and International Studies. New York: Rowman & Littlefield. Retrieved from: http://csis.org/files/publication/151112_Barnett_HumanCapital_Web.pdf
- Becker, K., & Park, K. (2011). Effects of integrative approaches among science, technology, engineering, and mathematics (STEM) subjects on students' learning: A preliminary meta-analysis. *Journal of STEM Education: Innovations and Research*, 12(5/6), 23.
- Beechler, S., & Woodward, I. C. (2009). The global "war for talent". *Journal of International Management*, 15(3), 273-285. doi:10.1016/j.intman.2009.01.002
- Beggs, J. M., Bantham, J. H., & Taylor, S. (2008). Distinguishing the factors influencing college students' choice of a major. *College Student Journal*, 42, 381-394.
- Bénabou, R., & Tirole, J. (2002). Self-confidence and personal motivation. *The Quarterly Journal of Economics*, 117(3), 871-915. Retrieved from: <http://www.jstor.org/stable/4132491>
- Berrebi, C., Martorell, F., & Tanner, J. C. (2009). Qatar's labor markets at a crucial crossroad. *The Middle East Journal*, 63(3), 421-442. doi:10.3751/63.3.14
- Bettinger, E. P., & Long, B. T. (2005). Do faculty serve as role models? The impact of instructor gender on female students. *The American Economic Review*, 95(2), 152-157. Retrieved from: <http://www.jstor.org/stable/4132808>
- Blazar, D. (2016). Teacher and teaching effects on students' academic performance, attitudes, and behaviors. *Doctoral dissertation, Harvard Graduate School of Education*. Retrieved from: <https://dash.harvard.edu/handle/1/27112692>
- Bloom, J. (2007). (Mis)reading social class in the journey towards college: Youth development in urban America. *Teachers College Record*, 109, 343-368.
- Boe, M. V., Henriksen, E. K., Lyons, T., & Schreiner, C. (2011). Participation in science and technology: Young people's achievement-related choices in late modern societies. *Studies in Science Education*, 47(1), 37-72. doi:10.1080/03057267.2011.549621
- Bong, M., & Clark, R. E. (1999). Comparison between self-concept and self-efficacy in academic motivation research. *Educational Psychologist*, 34(3), 139-153.
- Bong, M., & Skaalvik, E. M. (2003). Academic self-concept and self-efficacy: How different are they really? *Educational Psychology Review*, 15(1), 1-40.
- Bouhlila, D. S. (2011). The quality of secondary education in the Middle East and North Africa: What can we learn from TIMSS' results? *Compare: A Journal of Comparative and International Education*, 41(3), 327-352. doi:10.1080/03057925.2010.539887
- Brewer, D. J., Augustine, C. H., Zellman, G. L., Ryan, G. W., Goldman, C. A., & Ryan, G. (2007). *Education for a New Era: Design and implementation of K-12 education reform in Qatar*. Santa Monica, CA: RAND Corporation. Retrieved from: <http://www.rand.org/pubs/monographs/MG548.html>
- Business Higher Education Forum (BHEF). (2010). Increasing the number of STEM graduates: Insights from the U.S. STEM Education and Modeling Project. Retrieved from: http://www.bhef.com/sites/default/files/BHEF_2010_increasing_the_number_of_stem_grads.pdf
- Carter, G. (2011). The war for talent. *Australasian BioTechnology*, 21(1), 14.
- Cates, B. L., & Skinner, C. H. (2000). Getting remedial mathematics students to prefer homework with 20% and 40% more problems: An investigation of the strength of the interspersing procedure. *Psychology in the Schools*, 37, 339-347. doi:10.1002/1520-6807(200007)37:43.0.CO;2-7

- Chen X., & Soldner M. (2013). STEM Attrition: College students' paths into and out of STEM fields. *IES National Center for Education Studies, U.S Department of Education*. Retrieved from: <https://nces.ed.gov/pubs2014/2014001rev.pdf>
- Chen, C. H., & Zimitat, C. (2006). Understanding Taiwanese students' decision-making factors regarding Australian international higher education. *International Journal of Educational Management*, 20(2), 91-100. doi:10.1108/09513540610646082
- Cleveland, L. M., Olimpo, J. T., & DeChenne-Peters, S. E. (2017). Investigating the Relationship between Instructors' Use of Active-Learning Strategies and Students' Conceptual Understanding and Affective Changes in Introductory Biology: A Comparison of Two Active-Learning Environments. *CBE-Life Sciences Education*, 16(2), ar19. doi:10.1187/cbe.16-06-0181
- Crisp, G., Nora, A., & Taggart, A. (2009). Student characteristics, pre-college, college, and environmental factors as predictors of majoring in and earning a STEM degree: An analysis of students attending a Hispanic serving institution. *American Educational Research Journal*, 46, 924-942. doi:10.3102/0002831209349460
- De Bel-Air, F. (2014). Demography, migration, and labour market in Qatar. *Explanatory Note, Gulf Labour Market and Migration (GLMM)*, 8/2014. Migration Policy Center (MPC) and the Gulf Research Center (GRC). Retrieved from: <http://gulfmigration.eu>
- Dennen, V. P., Aubteen Darabi, A., & Smith, L. J. (2007). Instructor-learner interaction in online courses: The relative perceived importance of particular instructor actions on performance and satisfaction. *Distance Education*, 28(1), 65-79. doi:10.1080/01587910701305319
- Eaton, L., Sheppard, S., & Chen, H. (2014). Students' perspectives on homework and problem sets in STEM courses. *121st American Society for Engineering Education (ASEE) Conference and Exposition, Indianapolis*, June 15-18, 2014.
- Eccles, J. S. (1994). Understanding women's educational and occupational choices. *Psychology of Women Quarterly*, 18(4), 585-609.
- Etlinger, H. (2014). Expanding the Role of Homework Assignments. *The National Teaching & Learning Forum*, 23(6), 3-5.
- Forbes, A., & Skamp, K. (2014). 'Because we weren't actually teaching them, we thought they weren't learning': Primary teacher perspectives from the MyScience Initiative. *Research in Science Education*, 44(1), 1-25.
- Fouad, N. A., Hackett, G., Smith, P. L., Kantamneni, N., Fitzpatrick, M., Haag, S., & Spencer, D. (2010). Barriers and supports for continuing in mathematics and science: Gender and educational level differences. *Journal of Vocational Behavior*, 77, 361-373. doi:10.1016/j.jvb.2010.06.004
- Freeman, S., Eddy, S. L., McDonough, M., Smith, M. K., Okoroafor, N., Jordt, H., & Wenderoth, M. P. (2014). Active learning increases student performance in science, engineering, and mathematics. *Proceedings of the National Academy of Sciences*, 111(23), 8410-8415. doi:10.1073/pnas.1319030111
- Ganley, C. M., & Lubienski, S. T. (2016). Mathematics confidence, interest, and performance: Examining gender patterns and reciprocal relations. *Learning and Individual Differences*, 47, 182-193. doi:10.1016/j.lindif.2016.01.002
- Gasiewski, J. A., Eagan, M. K., Garcia, G. A., Hurtado, S., & Chang, M. J. (2012). From gatekeeping to engagement: A multicontextual, mixed method study of student academic engagement in introductory STEM courses. *Research in Higher Education*, 53(2), 229-261. doi:10.1007/s11162-011-9247-y
- General Secretariat for Development Planning (GSDP). (2008). *Qatar National Vision 2030*. Retrieved from: http://www.gsdp.gov.qa/portal/page/portal/gsdp_en/qatar_national_vision/qnv_2030_document on 08/04/2015
- General Secretariat for Development Planning (GSDP). (2011). *Qatar national development strategy 2011-2016 (NDS)*. Retrieved from: http://www.gsdp.gov.qa/gsdp_vision/docs/NDS_EN.pdf
- General Secretariat for Development Planning (GSDP). (2012). *Qatar's third national human development report: Expanding the capacities of Qatari youth*. Retrieved from: <http://www.readbag.com/www2-gsdp-qa-www1-docs-hdr3-en>
- Goldman, A. D., & Penner, A. M. (2014). Exploring international gender differences in mathematics self-concept. *International Journal of Adolescence and Youth*, 21(4), 403-418. doi:10.1080/02673843.2013.847850

- Gonzalez, G., Karoly, L. A., Constant, L., Salem, H., & Goldman, C. A. (2008). *Facing human capital challenges of the 21st century: Education and labor market initiatives in Lebanon, Oman, Qatar, and the United Arab Emirates*, 786. Santa Monica, CA: RAND Education.
- Gormally, C., Brickman, P., Hallar, B., & Armstrong, N. (2009). Effects of inquiry-based learning on students' science literacy skills and confidence. *International Journal for the Scholarship of Teaching and Learning*, 3(2), 16. doi:10.20429/ijstol.2009.030216
- Greenwood, C., Harrison, M., & Vignoles, A. (2011). *The labour market value of STEM qualifications and occupations*. London: Royal Academy of Engineering.
- Griffith, A. L. (2010). Persistence of women and minorities in STEM field majors: Is it the school that matters? *Economics of Education Review*, 29(6), 911-922. doi:10.1016/j.econedurev.2010.06.010
- Hall, C., Dickerson, J., Batts, D., Kauffmann, P., & Bosse, M. (2011). Are we missing opportunities to encourage interest in STEM fields? *Journal of Technology Education*, 23(1), 32-46. doi:10.21061/jte.v23i1.a.4
- Hasni, A., & Potvin, P. (2015). Student's interest in science and technology and its relationships with teaching methods, Family context and self-efficacy. *International Journal of Environmental and Science Education*, 10(3), 337-366. doi:10.12973/ijese.2015.249a
- Hayden, K., Ouyang, Y., Scinski, L., Olszewski, B., & Bielefeldt, T. (2011). Increasing student interest and attitudes in STEM: Professional development and activities to engage and inspire learners. *Contemporary Issues in Technology and Teacher Education*, 11(1), 47-69.
- Heaverlo, C. (2011). STEM development: A study of 6th-12th grade girls' interest and confidence in mathematics and science. Graduate Theses and Dissertations. Paper 10056. Retrieved from: <http://lib.dr.iastate.edu/cgi/viewcontent.cgi?article=1035&context=etd>
- Hidi, S., & Renninger, A. (2006). The four-phase model of interest development. *Educational Psychologist*, 41, 111-127.
- Hidi, S., Renninger, A., & Krapp, A. (2004). Interest, a motivational variable that combines affective and cognitive functioning. In D. Y. Dai, & R. J. Sternberg (Eds.), *Motivation, emotion, and cognition: Integrative perspectives on intellectual functioning and development*, 89-115. Mahwah, NJ: Lawrence Erlbaum Associates.
- Hill, C., Corbett, C., & St Rose, A. (2010). *Why so few? Women in science, technology, engineering, and mathematics*. Washington, DC: American Association of University Women (AAUW). Retrieved from: <http://files.eric.ed.gov/fulltext/ED509653.pdf>
- Hill, C., Rowan, B., and Ball, D. L. (2005). Effects of teachers' mathematical knowledge for teaching on student achievement. *American Educational Research Journal*, 42(2), 371-406.
- Hilton, T.L., & Lee, V.E. (1988). Student interest and persistence in science: Changes in the educational pipeline in the last decade. *The Journal of Higher Education*, 59(5), 510-526. doi:10.2307/1981701
- Hutcheson G. & Sofroniou N. (1999). *The multivariate social scientist: Introductory statistics using generalized linear models*. London: Sage Publication.
- Ibnouf, A., Dou, L., & Knight, J. (2014). The evolution of Qatar as an education hub: Moving to a knowledge-based economy. In J. Knight (Ed.), *International education hubs: Student, talent, knowledge-innovation models*, 43-61. New York: Springer. doi:10.1007/978-94-007-7025-6
- Ing, M., & Nylund-Gibson, K. (2013). Linking early science and mathematics attitudes to long-term science, technology, engineering, and mathematics career attainment: Latent class analysis with proximal and distal outcomes. *Educational Research and Evaluation*, 19(6), 510-524. doi:10.1080/13803611.2013.806218
- Ingersoll, R., Merrill, L., & May, H. (2014). What are the effects of teacher education and preparation on beginning teacher attrition? CPRE Research Reports. Retrieved from: http://repository.upenn.edu/cpre_researchreports/78
- Jiwaji, A. (2014). Shift in strategy required to satisfy GCC skills shortages. *Business in Qatar Magazine*. Retrieved from: <http://www.bq-magazine.com/economy/2014/08/shift-strategy-required-satisfy-gcc-skills-shortage>
- Joyce, A. (2014): Stimulating interest in STEM careers among students in Europe: Supporting career choice and giving a more realistic view of STEM at work. European Schoolnet, Brussels. Retrieved from:

- http://www.educationandemployers.org/wp-content/uploads/2014/06/joyce_-_stimulating_interest_in_stem_careers_among_students_in_europe.pdf
- Kitsantas, A., & Zimmerman, B. J. (2009). College students' homework and academic achievement: The mediating role of self-regulatory beliefs. *Metacognition and Learning*, 4(2), 97-110. doi: 10.1007/s11409-008-9028-y
- Krapp, A. (2007). An educational-psychological conceptualisation on interest. *International Educational Journal for Educational and Vocational Guidance*, 7, 5-21. doi:10.1007/s10775-007-9113-9
- Krapp, A., & Prenzel, M. (2011). Research on interest in science: Theories, methods, and findings. *International Journal of Science Education*, 33(1), 27-50. doi:10.1080/09500693.2011.518645
- Kuechler, W. L., McLeod, A., & Simkin, M. G. (2009). Why don't more students major in IS? *Decision Sciences Journal of Innovative Education*, 7, 463-488.
- Land, K. C. (1969). Principles of path analysis. *Sociological Methodology*, 1, 3-37.
- Lee, J., & Stankov, L. (2013). Higher-order structure of motivation, self-beliefs, learning strategies, and attitudes toward school and its prediction of PISA 2003 mathematics scores. *Learning and Individual Differences*, 26, 119-130. doi:10.1016/j.lindif.2013.05.004
- Louie, V. (2007). Who makes the transition to college? Why we should care? What we know, and what we need to do. *Teachers College Record*, 109(10), 2-3.
- Mahoney, M. P. (2010). *Student attitude toward STEM: Development of an instrument for high school STEM-based programs* (Unpublished PhD dissertation). Ohio State University, Columbus, OH. doi:10.21061/jots.v36i1.a.4
- Maltese, A. V., & Tai, R. H. (2010). Eyeballs in the fridge: Sources of early interest in science. *International Journal of Science Education*, 32(5), 669-685. doi:10.1080/09500690902792385
- Maltese, A. V., & Tai, R. H. (2011). Pipeline persistence: Examining the association of educational experiences with earned degrees in STEM among US students. *Science Education*, 95(5), 877-907. doi:10.1002/sce.20441
- Marshall, J. C., Horton, B., & White, C. (2009). EQUIPPing teachers: A protocol to guide and improve inquiry-based instruction. *The Science Teacher*, 76(4), 46-53.
- Mazzarol, T., & Soutar, G. N. (2002). "Push-pull" factors influencing international student destination choice. *International Journal of Educational Management*, 16(2), 82-90. doi:10.1108/09513540210418403
- McDonough, P. M. (2004). *The school-to-college transition: Challenges and prospects*. Washington, DC: American Council on Education, Center for Policy Analysis. Retrieved from: <http://www.bridgingworlds.org/P-20/McDonough.pdf>
- Michaels, E., Handfield-Jones, H., & Axelrod, B. (2001). *The war for talent*. Boston, Massachusetts: Harvard Business Press.
- Ministry of Development Planning and Statistics (2015). Qatar's Fourth National Human Development Report. *Realising Qatar National Vision 2030: The Right to Development*. Retrieved from: <http://www.mdps.gov.qa>
- Morony, S., Kleitman, S., Lee, Y. P., & Stankov, L. (2013). Predicting achievement: Confidence vs self-efficacy, anxiety, and self-concept in Confucian and European countries. *International Journal of Educational Research*, 58, 79-96. doi:10.1016/j.ijer.2012.11.002
- Mullis, I. V. S., Martin, M. O., Foy, P., & Hooper, M. (2016). TIMSS 2015 International Results in Mathematics. TIMSS & PIRLS International Study Center at Boston College. Retrieved from: <http://timss2015.org/wp-content/uploads/filebase/full%20pdfs/T15-International-Results-in-Mathematics.pdf>
- Mullis, I. V. S., Martin, M. O., & Foy, P. (2009). TIMSS 2007 International Mathematics Report. Findings from IEA's trends in international mathematics and science study at the fourth and eighth grades. Chestnut Hill, MA: TIMSS & PIRLS International Study Center, Boston College.
- National Research Council. (2011). *Successful K-12 STEM education: Identifying effective approaches in science, technology, engineering, and mathematics*. Washington, DC: The National Academies Press.
- Organisation for Economic Co-Operation and Development (OECD) (2010). PISA 2009 Results: What Students Know and Can Do - Student Performance in Reading, Mathematics and Science (Volume I). Retrieved from: http://www.oecd-ilibrary.org/education/pisa-2009-results-what-students-know-and-can-do_9789264091450-en

- Organisation for Economic Co-Operation and Development (OECD) (2014). PISA 2012 results in focus: What 15 year olds know and what they can do with what they know. Retrieved from: <http://www.oecd.org/pisa/keyfindings/pisa-2012-results-overview.pdf>
- Organisation for Economic Co-Operation and Development (OECD) (2016). PISA 2015 Results in Focus. Retrieved from: <http://www.oecd.org/pisa/pisa-2015-results-in-focus.pdf>
- Osborne, J., Simon, S., & Collins, S. (2003). Attitudes towards science: A review of the literature and its implications. *International Journal of Science Education*, 25(9), 1049–1079. doi:10.1080/0950069032000032199
- Osman, I., & Anouze, A. (2014). A cognitive analytics management framework (CAM-Part 3): Critical skills shortage, higher education trends, education value chain framework, government strategy. In I. Osman, A. Anouze, & A. Emrouznejad (Eds.), *Handbook of research on strategic performance management and measurement using data envelopment analysis*, 190–234. Hershey, PA: Business Science Reference, IGI Global. doi:10.4018/978-1-4666-4474-8.ch003.
- Oxford Strategic Consulting (2015). *Maximizing Qatari talent – Executive summary*. Oxford Strategic Consulting. Retrieved from: <http://www.oxfordstrategicconsulting.com/wp-content/uploads/2015/04/Maximising-Qatari-Talent-Report1.pdf>
- Oxford Strategic Consulting (2016). *Qatar employment report: Insights for 2016*. Oxford Strategic Consulting. Retrieved from: http://www.oxfordstrategicconsulting.com/wp-content/uploads/2016/02/OxfordStrategicConsulting_QatarEmployment_Jan2016.pdf
- Pimpa, N. (2003). The influence of family on Thai student choices of international education. *The International Journal of Educational Management*, 17(5), 211–219. doi:10.1108/09513540310484931
- Potvin, P., & Hasni, A. (2014). Interest, motivation and attitude towards science and technology at K-12 levels: a systematic review of 12 years of educational research. *Studies in Science Education*, 50(1), 85–129. doi:10.1080/03057267.2014.881626
- Price, I., Matzdorf, L., & Agahi, R. (2003). The impact of facilities on student choice of university. *International Journal of Educational Management*, 21(10), 212–222. doi:10.1108/02632770310493580
- Price, J. (2010). The effect of instructor race and gender on student persistence in STEM fields. *Economics of Education Review*, 29(6), 901–910. doi:10.1016/j.econedurev.2010.07.009
- Qatar University. (2017). *Qatar University Book of Trends*. Doha, Qatar: Qatar University
- Renninger, K. A. & Hidi, S. (2011). Revisiting the conceptualization, measurement, and generation of interest. *Educational Psychologist*, 46(3), 168–184. doi:10.1080/00461520.2011.587723.
- Rittmayer, A. D., & Beier, M. E. (2008). Overview: Self-efficacy in STEM. *SWE-AWE CASEE Overviews*. Retrieved from: http://www.engr.psu.edu/awe/misc/arps/arp_selfefficacy_overview_122208.pdf
- Rock, C. (2010). Irish secondary school students' intention to pursue higher education: an investigation to identify the strongest predictors. *Student Psychology Journal*, 1, 77–93.
- Rugh, W. A. (2002). Arab education: Tradition, growth and reform. *The Middle East Journal*, 396–414. Retrieved from: <http://www.jstor.org/stable/4329785>
- Sadler, P. M., Sonnert, G., Coyle, H. P., Cook-Smith, N., & Miller, J. L. (2013). The influence of teachers' knowledge on student learning in middle school physical science classrooms. *American Educational Research Journal*, 50(5), 1020–1049. doi:10.3102/0002831213477680
- Said, Z. (2016). Science education reform in Qatar: Progress and challenges. *Eurasia Journal of Mathematics, Science & Technology Education*, 12(8), 2253–2265. doi:10.12973/eurasia.2016.1301a
- Said, Z., Summers, R., Abd-El-Khalick, F., & Wang, S. (2016). Attitudes toward science among grades 3 through 12 Arab students in Qatar: findings from a cross-sectional national study. *International Journal of Science Education*, 38(4), 621–643. doi:10.1080/09500693.2016.1156184
- Sarsons, H., & Xu, G. (2015). Confidence Men? Gender and Confidence: Evidence among Top Economists. Harvard University, Department of Economics, Littauer Center, 1–26. Retrieved from: http://scholar.harvard.edu/files/sarsons/files/confidence_final.pdf
- Schiefele, U. (2009). Situational and individual interest. In K. R. Wentzel., & A. Wigfield (Eds.), *Handbook of motivation at school*. Mahwah, NJ: Erlbaum.

- Shapiro, E. S. (1996). *Academic skills problems: Direct assessment and intervention*. New York: Guilford.
- Shediac, R., & Samman, H. (2010). *Meeting the employment challenge in the GCC: The need for a holistic strategy*. Abu Dhabi, U.A.E.: Booz & Co. Retrieved from: http://www.ideationcenter.com/ideation_research/ideation_article/meeting-employment-challenge-in-gcc on 09/04/15
- Sjaastad, J. (2012). Sources of inspiration: The role of significant persons in young people's choice of science in higher education. *International Journal of Science Education*, 34(10), 1615-1636. doi:10.1080/09500693.2011.590543
- Slapcoff, M., Dobler, E., & Tovar, M. (Eds.). (2011). *Using coursework to enhance students' understanding of research/scholarship: A report from the Inquiry Network*. Montreal: Teaching and Learning Services, McGill University.
- Smolira, J. C. (2008). Student perceptions of online homework in introductory finance courses. *Journal of Education for Business*, 84(2), 90-95. doi:10.3200/JOEB.84.2.90-95
- St. John, E. P. (2002). *The access challenge: Rethinking the cause of the new inequality*. Bloomington, IN: Indiana University, Educational Policy Center.
- Stasz, C., Eide, E.R. & Martorell, P. (2007). *Post-secondary education in Qatar: Employer demand, student choice, and options for policy*. Santa Monica, CA: RAND Education.
- Stearns, E., Bottia, M. C., Davalos, E., Mickelson, R. A., Moller, S., & Valentino, L. (2016). Demographic Characteristics of High School Math and Science Teachers and Girls' Success in STEM. *Social Problems*, 63, 87-110. doi:10.1093/socpro/spv027
- Su, R., & Rounds, J. (2015). All STEM fields are not created equal: People and things interests explain gender disparities across STEM fields. *Frontiers in Psychology*, 6, 189-189. doi:10.3389/fpsyg.2015.00189
- Tai, R. H., Liu, C.Q., Maltese, A.V., & Fan, X. (2006). Planning early for careers in science. *Science*, 312, 1143-1144.
- Tavani, C. M., & Losh, S. C. (2003). Motivation, self-confidence, and expectations as predictors of the academic performances among our high school students. *Child Study Journal*, 33(3), 141-152.
- Taylor, A., Jones, G., Broadwell, B., & Oppewal, T. (2008). Creativity, inquiry, or accountability? Scientists' and teachers' perceptions of science education. *Science Education*, 92(6), 1058-1075. doi:10.1002/sc.20272
- The Sutton Trust (2011). *Improving the impact of teachers on pupil achievement in the UK - interim findings. Executive summary. The Sutton Trust-Education Endowment Foundation Teaching and Learning Toolkit*. London: Education Endowment Foundation. Retrieved from: <https://www.suttontrust.com/wp-content/uploads/2011/09/2teachers-impact-report-final.pdf>
- Thompson, M. D. (2001). Informal student-faculty interaction: Its relationship to educational gains in science and mathematics among community college students. *Community College Review*, 29(1), 35-57.
- Trautwein, U. (2007). The homework-achievement relation reconsidered: Differentiating homework time, homework frequency, and homework effort. *Learning and Instruction*, 17(3), 372-388. doi:10.1016/j.learninstruc.2007.02.009
- Trautwein, U., & Köller, O. (2003). The relationship between homework and achievement—still much of a mystery. *Educational Psychology Review*, 15(2), 115-145. doi:10.1023/A:1023460414243
- Trautwein, U., Köller, O., Schmitz, B., & Baumert, J. (2002). Do homework assignments enhance achievement? A multilevel analysis in 7th-grade mathematics. *Contemporary Educational Psychology*, 27(1), 26-50. doi:10.1006/ceps.2001.1084
- Tyson, W., Lee, R., Borman, K. M., & Hanson, M. A. (2007). Science, technology, engineering, and mathematics (STEM) pathways: High school science and math coursework and postsecondary degree attainment. *Journal of Education for Students Placed at Risk*, 12(3), 243-270. doi:10.1080/10824660701601266
- Wang, X. (2013). Why students choose STEM majors: Motivation, high school learning, and postsecondary context of support. *American Educational Research Journal*, 50(5), 1081-1121. doi:10.3102/0002831213488622
- Warton, P. M. (2001). The forgotten voices in homework: Views of students. *Educational Psychologist*, 36(3), 155-165. doi:10.1207/S15326985EP3603_2

- Watkins, J., & Mazur, E. (2013). Retaining students in science, technology, engineering, and mathematics (STEM) majors. *Journal of College Science Teaching*, 42(5), 36–41.
- Weber, A. S. (2014b). Linking education to creating a knowledge society: Qatar's investment in the education sector. In N. Baporikar (Ed.), *Handbook of research on higher education in the MENA region: Policy and practice* (pp. 52–73). Hershey, Pennsylvania: Business Science Reference, IGI Global. doi:10.4018/978-1-4666-7363-2.ch044
- Weber, A. S. (2014a). Education, development and sustainability in Qatar: A case study of economic and knowledge transformation in the Arabian Gulf. In A. W. Wiseman, N. H. Alromi, & S. Alshumrani (Eds.), *Education for a knowledge society in Arabian Gulf countries* (pp. 59–82). Bingley, UK: Emerald Group Publishing Limited.
- Wiseman, A. W., Alromi, N. H. & Alshumrani, S. (2014). *Education for a knowledge society in Arabian Gulf countries*. London: Emerald Group Publishing.
- Zimmerman, B. J., & Kitsantas, A. (2005). Homework practices and academic achievement: The mediating role of self-efficacy and perceived responsibility beliefs. *Contemporary Educational Psychology*, 30(4), 397–417. doi:10.1016/j.cedpsych.2005.05.003.

<http://www.ejmste.com>



<http://www.ejmste.com>



<https://twitter.com/ejmste>



<https://www.facebook.com/ejmste>



<http://modestum.co.uk/>



publications@modestum.co.uk



Animals in Dangerous Postures Enhance Learning, but Decrease Willingness to Protect Animals

Pavol Prokop

Department of Biology, Faculty of Education, Trnava University, Priemysel'na 4, 918 43, Trnava, Slovakia
Institute of Zoology, Slovak Academy of Sciences, Dúbravská cesta 9, 845 06 Bratislava, Slovakia

Jana Fančovičová

Department of Biology, Faculty of Education, Trnava University, Priemysel'na 4, 918 43, Trnava, Slovakia

Received 23 February 2017 • Revised 18 July 2017 • Accepted 2 August 2017

ABSTRACT

Animals are the most prevalent subjects for photographs in science textbooks. Many of them are potentially dangerous to humans, and visual exposure to potential threat can influence learning outcomes as well as emotional attachment to these animals. We experimentally investigated the influence of animal posture (aggressive-looking *vs.* neutral-looking) on 10 - 13-year-old pupils' information retention and willingness to support the protection of these animals. We found that information placed below aggressive-looking animals was retained significantly better than information placed below neutral-looking animals. Survival-relevant information was retained better than survival-irrelevant information. Willingness to protect aggressive-looking animals was lower than willingness to protect neutral-looking animals. This suggests that aggressive-looking pictures receive stronger attention, but do not distract pupils from learning. Aggressive animals may have a negative influence on animal conservation efforts.

Keywords: animals, adaptive memory, pupils, pictures

INTRODUCTION

Textbooks are the primary resources in pupils' learning (Tolman, Hardy, & Sudweeks, 1998) and photographs constitute a major aspect of school science texts (Poizzer & Roth, 2003; Roth, Bowen, & McGinn, 1999). Photographs in textbooks make the learning material more attractive and interesting (Male, 2007; Rubens, 2000) and induce a better mood, alertness and calmness with pupils (Lenzner, Schnotz, & Müller, 2013). Indeed, pupils generally learn better from text and pictures than from text alone (Levie & Lentz, 1982; Levin, Anglin, & Carney, 1987).

Animals are the most prevalent subjects of the photographs in science textbooks (Link-Pérez, Dollo, Weber, & Schussler, 2010). This can be explained by the natural affinity of humans to animals. Historically, animals have been important sources for the human diet, but also pose a physical danger (Treves & Palmqvist, 2007). This is why animals receive increased attention by humans (the animate monitoring hypothesis, see New, Cosmides, & Tooby, 2007). Indeed, animals are visually preferred by two-day-old babies more than non-biological targets (Simion et al. 2008) and are detected more rapidly than plants (Balas & Momen, 2014). Predatory animals are detected faster than flowers or mushrooms (LoBue & DeLoache, 2008; Öhman, Flykt, & Esteves, 2001) and tracked by the eyes for a longer time than non-predatory animals (Penkunas & Coss, 2013; Yorzinski, Penkunas, Platt, &

© **Authors.** Terms and conditions of Creative Commons Attribution 4.0 International (CC BY 4.0) apply.

Correspondence: Pavol Prokop, *Department of Biology, Faculty of Education, Trnava University, Priemysel'na 4, 918 43, Trnava, Slovakia.*

✉ pavol.prokop@savba.sk

State of the literature

- Animals are frequently the subjects of photographs in science textbooks.
- Fear elicited by animals may influence both cognitive and emotional processes.
- Fear may distract pupils from learning.

Contribution of this paper to the literature

- Some information about aggressive-looking animals was retained better than information about neutral-looking animals.
- Survival-relevant information was retained better than survival-irrelevant information.
- Willingness to protect aggressive-looking animals was lower than willingness to protect neutral-looking animals.

Coss, 2014). Observations by children and adults revealed that physical interaction with live animals was more frequent than with toys (LoBue, Bloom Pickard, Sherman, Axford, & DeLoache, 2013). This evidence suggests that humans have an innate preference for animals and predatory animals in particular receive stronger attention.

Pictures in textbooks have not only a cognitive, but also an affective influence on learning (Carney & Levin, 2002; Lenzner, Schnotz, & Müller, 2013; Levie & Lentz, 1982). By means of looking at textbook pictures, increased pupil interest may enhance willingness to learn, and activate cognitive strategies that lead to more effective learning (Schraw & Lehman, 2001; Vollmeyer & Rheinberg, 2006). Most of the research was carried out on “positive” aspects, e.g. on enhancing mood (Lenzner et al., 2013). Animals are special, however, as some of them may pose a danger to humans. Perceived danger increases fear and fear memories are deeply stored in the brain (Johansen, Cain, Ostroff, & LeDoux, 2011; McGaugh, 2000). Indeed, Chapman, Johannes, Poppenk, Moscovitch and Anderson (2013) revealed that items scoring high in fear are remembered better than neutral items. Štefaniková and Prokop (2015) found that information concerning dangerous animals was retained better than information about non-dangerous animals in all probability because retaining survival-relevant information is ultimately more advantageous than retaining survival-irrelevant information (Nairne, 2010; Nairne, Thompson, & Pandeirada, 2007).

It has been speculated that danger from animals is elicited by certain harmful shapes, such as teeth, claws or spikes (Štefaniková & Prokop, 2015; Souchet & Aubret, 2016). Presentation of animals in science textbooks may contain these aggressive cues, but it is not clear whether these cues influence learning. On the one hand, fear may enhance learning (e.g., Chapman et al. (2013), but on the other hand, if aggressive pictures attract more attention, it can be argued that they also distract the pupil from learning (Sanchez & Wiley, 2006). Furthermore, visual exposure to colour photographs of animals positively influenced the willingness to protect them (Štefaniková & Prokop, 2013). Willingness to protect animals is, however, influenced by their perceived aesthetic value (Gunnthorsdottir, 2001; Knight, 2008; Prokop & Fančovičová, 2013a; Soga, Gaston, Yamaura, Kurisu, & Hanaki, 2016) and perceived fear (Prokop & Fančovičová, 2010; Johansson, Sjöström, Karlsson, & Brännlund, 2012). It is again not clear how dangerous cues may influence willingness to protect animals.

In the present study, we presented various colourful pictures of animals to pupils and investigated whether aggressive-looking animals influence 1) information retention about them and 2) willingness to support animal protection compared with the control, neutral-looking animals.

MATERIALS AND METHODS

Participants

A convenience sample of 150 pupils was used in this research, but the final sample comprised 91 pupils (48 females) who completed both test and retest. These pupils were fifth and sixth graders from three higher primary schools and seven classes. The age of the pupils was 10 – 13 years ($M = 11.23$, $SE = 0.08$, $n = 91$). Participants were unaware of our hypotheses.

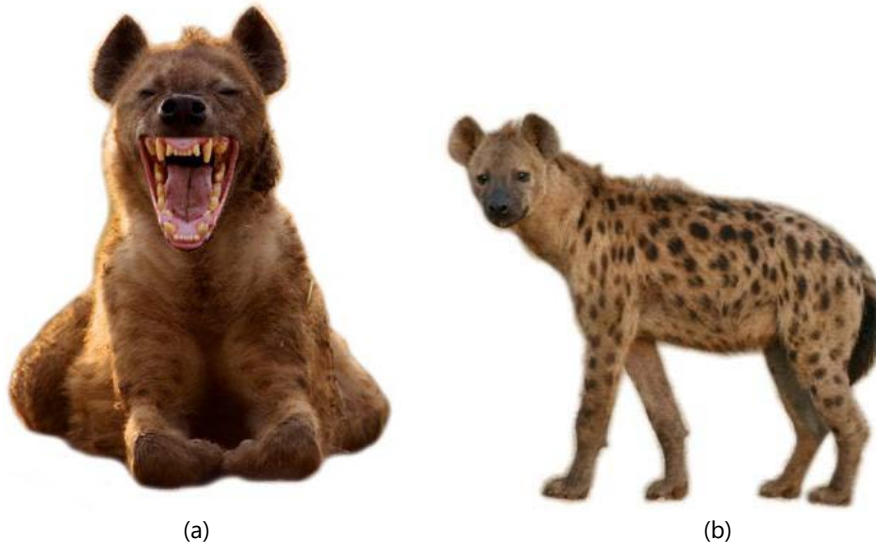

Figure 1. An example of the spotted hyena as an animal presented in a) aggressive and b) neutral posture

Species Selection

Animals which pose a potential danger to humans were used in this research: dingo (*Canis lupus dingo*), common lancehead (*Bothrops atrox*), fossa (*Cryptoprocta ferox*), Indian red scorpion (*Hottentotta tamulus*), spotted hyena (*Crocota crocuta*), snow leopard (*Panthera uncia*), common hippopotamus (*Hippopotamus amphibius*), collared peccary (*Tayassu tajacu*), wolverine (*Gulo gulo*) and hamadryas baboon (*Papio hamadryas*). Pictures of all these species were found in both aggressive (or at least with visible weapons dangerous to humans such as teeth) and a neutral posture with Google (Figure 1a, & 1b). The pictures had a similar size, contrast, brightness and all had removed the background. We chose species that do not occur in Slovakia to avoid previous experience and familiarity of the participants with the presented animals.

Procedure

Participants were randomly divided into two groups (A and B). Both groups were shown species in both aggressive and neutral postures in both the test and retest. If, for example, a participant in Group A was shown the fossa in a neutral posture, participants in Group B were shown the fossa in an aggressive posture. Both test and retest were administered online and participants filled out the questionnaire during biology lessons.

In the test (first trial), participants were asked basic demographic information such as grade, gender, age and name. There was a need to do this research non-anonymously, because participants of this age frequently lose their ID numbers and, moreover, if the ID number is required for the next trial, they could have the suspicion that they were going to be examined again. The participant's name was the only way to pair data from the test and retest. The participants were then shown a series of 10 pictures. Each picture contained one animal (a frog, reptile, bird and mammal) which was presented individually for 1 min. Over this time, the participants rated their perceived fear (How dangerous would you consider this animal?) on a 10-point scale (1 = not at all dangerous, 10 = extremely dangerous) and the willingness to protect the animal (Do you think that this species should be protected by laws?) (yes or no). The reliability was acceptable (Cronbach's alpha = 0.64 and 0.74, respectively). Ratings of perceived danger and willingness to protect animals were applied only once (in the test, not in the retest). Some basic information regarding the name of the animal, its occurrence, food habits and danger to humans then appeared on the slide below the picture. This information was standardized to a similar length of text and there were only four types of information mentioned above. Participants were instructed to read this information.

Table 1. Results of Linear Mixed Model (MIXED) with repeated measures on an average memory score

Main effects	df	F	p
Intercept	1,107	5.21	.024
1. Type of animal	1,1356	11.63	.001
2. Gender	1,72	0.12	.73
3. Type of question	3,1356	58.3	.001
4. Age (covariate)	1,108	0.09	.76
Interaction terms			
1 × 2	1,1356	0.29	.59
1 × 3	3,1356	9.26	.001
2 × 3	3,1356	3.63	.05
1 × 2 × 3	3,1356	1.74	.16

After the ratings of all 10 animals was completed, a surprise memory test appeared. Each of the 10 slides contained only a picture with an animal, but instead of the text with information, four open-ended questions regarding the animal name, occurrence, food and dangerousness to humans appeared. To examine which items had passed into long-term memory, the retest (second trial) was administered one week later and contained the same four questions regarding 10 animal species. Similar procedure can be found elsewhere (e.g., Barrett & Broesch, 2012; Prokop & Fančovičová, 2014). The participants were then debriefed and dismissed.

The participant's responses were coded as correct (2 points), partly correct (some information missing, 1 point) and incorrect/do not know (0 points). Example: Where does the animal [collared peccary] occur? Both North and South America (correct); South America *or* North America (partly correct); Asia, Africa, or do not know (incorrect). Average scores were calculated for animals presented in aggressive and neutral postures separately.

Statistical Analyses

Linear Mixed Model (MIXED) with repeated measures was used to examine the obtained data. The participant's ID and the group of participants (A or B) were treated as random factors. These variables showed no influence on the dependent variables (Wald Z = -1.38 and 1.43, p = .17 and .15, respectively). Test - retest measures were treated as repeated measures. The participant's sex, the type of presented animal (aggressive vs. neutral posture) and the type of question (naming, occurrence, food and danger) were defined as categorical predictors and age was a covariate. Since females may perceive animals somewhat differently than males (see Herzog 2007 for discussion), we included gender into statistical analyses. Scores from four questions were dependent variables. Test memory scores were significantly higher than retest memory scores (Wald Z = 26.04, p < .001). No significant interactions between test-retest scores and other variables appeared, thus this variable was not further examined. Statistical analyses were performed with IBM SPSS ver. 22.

RESULTS

The Influence of Animal Appearance on Information Retention

The results of the Linear Mixed Model on memory scores (mean scores of four knowledge questions) are shown in **Table 1**. Aggressive-looking animals received higher memory scores compared with neutral-looking animals (analysis of contrasts, t = 3.36, p = .001).

The type of question also influenced memory scores; the highest scores were received for items regarding danger and food, while the lowest scores were received for naming of animals and occurrence. These patterns were very consistent in both test and re-test (**Figure 2a, & 2b**).

The interaction term Type of animal × Type of question suggests that pupils received higher memory scores from questions regarding animal dangerousness and food particularly when an animal looked dangerous

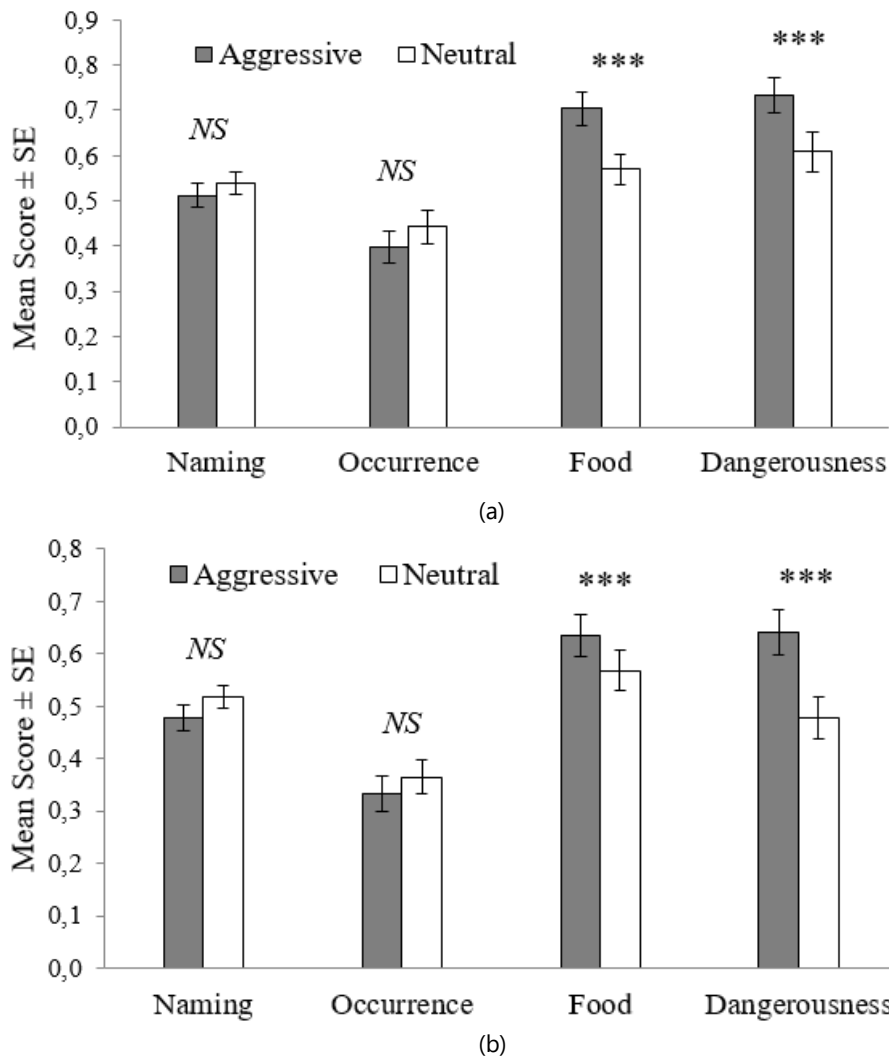

Figure 2. Differences in memory scores based on four questions in test (a) and retest (b). *** $p < .001$, NS = not statistically significant

(Figure 2a, & 2b). The remaining two questions (naming and occurrence) received similar memory scores irrespective of the type of animal.

The interaction term Gender \times Type of question suggests that females retained more information regarding animal danger than males, but males scored higher in questions regarding animal occurrence.

Animal Danger and Willingness to Support Animal Protection

Animals presented in aggressive postures were subjectively rated by pupils in a test as more dangerous than animals in neutral postures ($M = 5.29$, $SE = 0.08$ vs. $M = 4.21$, $SE = 0.1$, both $n_1 = n_2 = 91$, t-test, $t = 8.79$, $df = 180$, $p < .001$). This result provides some support for the validity of the selected stimuli. Pupils were less willing to protect animals presented in aggressive postures compared with animals in neutral postures ($M = 0.58$, $SE = 0.03$ vs. $M = 0.69$, $SE = 0.03$, $n_1 = n_2 = 91$, t-test, $t = 2.3$, $df = 180$, $p = .022$).

DISCUSSION

This study investigated the influences of aggressive animal postures on pupil's learning outcomes and their willingness to protect these animals. We found that aggressive-looking animals significantly influenced both these variables. Pupils retained more information about aggressive-looking animals than about neutral-looking animals, but were less likely to support protection of aggressive-looking animals compared with neutral-looking animals.

Information Retention Concerning Aggressive-Looking Animals

The same animal species produced different information retention scores in pupils, because more information about aggressive-looking individuals was retained than about neutral-looking individuals. These results are in agreement with previous research (Štefaniková & Prokop, 2013, 2015). Certain neural processes which are activated in fear-learning (Chapman et al., 2013; Johansen et al., 2011; McGaugh, 2000) would at least partly influence these results. Both pupils and adults, for example, detected the photos of snakes displaying a striking posture faster than the photos of resting snakes (Masataka, Hayakawa, & Kawai, 2011). It can be suggested that aggressive-looking pictures could attract more attention (Penkunas & Coss, 2013; Yorzinski et al., 2014) and stimulated situational interest enhanced information retention (Harp & Mayer, 1997; Hidi & Baird, 1988; Schraw & Lehman, 2001). This possibility can be further investigated by combining an eye-tracking technique with self-reports regarding interest in particular animals. Importantly, pictures with aggressive-looking animals do not appear to distract pupils from learning (Sanchez & Wiley, 2006) as higher information retention scores were obtained compared with neutral-looking animals.

The type of question significantly influenced information retention. Questions about dangerousness and food, in particular, received higher scores than questions regarding the naming of animals and their diet. These results are, again, compatible with previous research on both animals (Barrett & Broesch, 2012; Štefaniková & Prokop, 2013, 2015) and plants (Prokop & Fančovičová, 2014; Prokop et al., 2016), suggesting that survival-relevant information is retained better than survival-irrelevant information (e.g., Nairne, 2010; Nairne & Pandeirada, 2010; Nairne, Pandeirada, Gregory, & Van Arsdall, 2009). This is, however, true particularly for dangerousness, not for an animal's diet. Although previous research also found that scores for diet were higher than scores for occurrence and naming (Barrett & Broesch, 2012), it is not fully clear why the score for diet was similarly high as scores for danger. Finally, it is also not fully clear why the score for diet was better retained compared with naming and occurrence, but it suggests that not all information is better retained under an aggressive-looking condition.

Gender differences in information retention were weak, similarly as in earlier research (Štefaniková & Prokop, 2013, 2015). Females, however, manifested better information retention regarding animal danger than males. It is possible that females overperceive the danger posed by animals, because of their higher vulnerability of being killed by a dangerous predator (Prokop & Fančovičová, 2013b; Treves & Naughton-Treves, 1999). Males, in contrast, scored higher in questions regarding animal occurrence than females. This can be explained by the higher interest on the part of males in less popular animals such as snails, bats, and rats (Bjerke & Østdahl, 2004) and exotic wild animals (Lindemann-Matthies, 2005).

Willingness to Support Animal Protection

Lower willingness to support animal protection correlates (among other things) with their perceived aesthetic value (Ceríaco, 2012; Gunnthorsdottir, 2001; Knight, 2008; Prokop & Fančovičová, 2013a). Although this variable was not specifically examined in this study, aggressive-looking animals are in all probability perceived as less appealing than the same, but neutral-looking animals. This has important implications for environmental conservation and conservation programmes; aggressive-looking animals may receive lower public support ultimately because their presence may activate fear-motivated behaviour after exposure to danger (Öhman et al., 2001). We further recommend critical evaluation of natural history films about predators and their impact on an individual's motivation to protect them. It is possible that less pleasant, predatory scenes, can have a negative influence on environmental conservation efforts.

In conclusion, differences, not only between-species but also within-species, influence the perception of animals by pupils. We demonstrated that pictures with aggressive-looking animals are associated with better information retention, but the same pictures have a negative influence on willingness to support animal protection. This information is potentially important for teachers and developers of learning material who may alter the appearance of animals in textbook pictures. It is not actually clear as to whether our findings can be applied exclusively on pupils who are more vulnerable to predation threat, and could therefore be more sensitive to aggression cues than adults. Additional, cross-age research in this field is necessary before a final conclusion can be reached.

ACKNOWLEDGEMENTS

We would like to thank all the volunteers who participated in this research. Soňa Štefaniková helped with data collection. David Livingstone improved the English. This research was supported by the university grant no. 2/TU/2017 and 5/TU/2017 and KEGA no. 001PU-4/2017.

REFERENCES

- Balas, B., & Momsen, J. L. (2014). Attention “blinks” differently for plants and animals. *CBE-Life Sciences Education*, 13(3), 437-443.
- Barrett, H. C., & Broesch, J. (2012). Prepared social learning about dangerous animals in children. *Evolution and Human Behavior*, 33(5), 499-508.
- Bjerke, T., & Østdahl, T. (2004). Animal-related attitudes and activities in an urban population. *Anthrozoös*, 17(2), 109-129.
- Carney, R. N., & Levin, J. R. (2002). Pictorial illustrations still improve students’ learning from text. *Educational Psychology Review*, 14(1), 5-26.
- Ceríaco, L. M. (2012). Human attitudes towards herpetofauna: The influence of folklore and negative values on the conservation of amphibians and reptiles in Portugal. *Journal of Ethnobiology and Ethnomedicine*, 8(1), 8.
- Gunnthorsdottir, A. (2001). Physical attractiveness of an animal species as a decision factor for its preservation. *Anthrozoös*, 14(4), 204-215.
- Harp, S. F., & Mayer, R. E. (1997). The role of interest in learning from scientific text and illustrations: On the distinction between emotional interest and cognitive interest. *Journal of Educational Psychology*, 89(1), 92-102.
- Herzog, H. A. (2007). Gender differences in human-animal interactions: A review. *Anthrozoös*, 20(1), 7-21.
- Hidi, S., & Baird, W. (1988). Strategies for increasing text-based interest and students’ recall of expository texts. *Reading Research Quarterly*, 23(4), 465-483.
- Chapman, H. A., Johannes, K., Poppenk, J. L., Moscovitch, M., & Anderson, A. K. (2013). Evidence for the differential salience of disgust and fear in episodic memory. *Journal of Experimental Psychology: General*, 142(4), 1100-1112.
- Johansen, J. P., Cain, C. K., Ostroff, L. E., & LeDoux, J. E. (2011). Molecular mechanisms of fear learning and memory. *Cell*, 147(3), 509-524.
- Johansson, M., Sjöström, M., Karlsson, J., & Brännlund, R. (2012). Is human fear affecting public willingness to pay for the management and conservation of large carnivores?. *Society & Natural Resources*, 25(6), 610-620.
- Knight, A. J. (2008). “Bats, snakes and spiders, Oh my!” How aesthetic and negativistic attitudes, and other concepts predict support for species protection. *Journal of Environmental Psychology*, 28(1), 94-103.
- Leivas Pozzer, L., & Roth, W. M. (2003). Prevalence, function, and structure of photographs in high school biology textbooks. *Journal of Research in Science Teaching*, 40(10), 1089-1114.
- Lenzner, A., Schnotz, W., & Müller, A. (2013). The role of decorative pictures in learning. *Instructional Science*, 41(5), 811-831.
- Levie, W. H., & Lentz, R. (1982). Effects of text illustrations: A review of research. *ECTJ*, 30(4), 195-232.

- Levin, J. R. (1987). On empirically validating functions of pictures in prose. In: Willows, D.M. and Houghton, H.A., Eds., *The Psychology of Illustration: Basic Research*. Springer, New York, 51-85.
- Lindemann-Matthies, P. (2005). 'Loveable' mammals and 'lifeless' plants: how children's interest in common local organisms can be enhanced through observation of nature. *International Journal of Science Education*, 27(6), 655-677.
- Link-Pérez, M. A., Dollo, V. H., Weber, K. M., & Schussler, E. E. (2010). What's in a Name: Differential labelling of plant and animal photographs in two nationally syndicated elementary science textbook series. *International Journal of Science Education*, 32(9), 1227-1242.
- Link-Pérez, M. A., Dollo, V. H., Weber, K. M., & Schussler, E. E. (2010). What's in a name: Differential labelling of plant and animal photographs in two nationally syndicated elementary science textbook series. *International Journal of Science Education*, 32(9), 1227-1242.
- LoBue, V., & DeLoache, J. S. (2008). Detecting the snake in the grass: Attention to fear-relevant stimuli by adults and young children. *Psychological Science*, 19(3), 284-289.
- LoBue, V., Bloom Pickard, M., Sherman, K., Axford, C., & DeLoache, J. S. (2013). Young children's interest in live animals. *British Journal of Developmental Psychology*, 31(1), 57-69.
- Masataka, N., Hayakawa, S., & Kawai, N. (2010). Human young children as well as adults demonstrate 'superior' rapid snake detection when typical striking posture is displayed by the snake. *PLoS One*, 5(11), e15122.
- McGaugh, J. L. (2000). Memory--a century of consolidation. *Science*, 287(5451), 248-251.
- Nairne, J. S. (2010). Adaptive memory: Evolutionary constraints on remembering. *Psychology of Learning and Motivation*, 53, 1-32.
- Nairne, J. S., & Pandeirada, J. N. (2010). Adaptive memory: Ancestral priorities and the mnemonic value of survival processing. *Cognitive Psychology*, 61(1), 1-22.
- Nairne, J. S., Pandeirada, J. N., Gregory, K. J., & Van Arsdall, J. E. (2009). Adaptive memory: Fitness relevance and the hunter-gatherer mind. *Psychological Science*, 20(6), 740-746.
- Nairne, J. S., Thompson, S. R., & Pandeirada, J. N. (2007). Adaptive memory: survival processing enhances retention. *Journal of Experimental Psychology: Learning, Memory, and Cognition*, 33(2), 263-273.
- New, J., Cosmides, L., & Tooby, J. (2007). Category-specific attention for animals reflects ancestral priorities, not expertise. *Proceedings of the National Academy of Sciences*, 104(42), 16598-16603.
- Öhman, A., Flykt, A., & Esteves, F. (2001). Emotion drives attention: detecting the snake in the grass. *Journal of Experimental Psychology: General*, 130(3), 466-478.
- Penkunas, M. J., & Coss, R. G. (2013). Rapid detection of visually provocative animals by preschool children and adults. *Journal of Experimental Child Psychology*, 114(4), 522-536.
- Prokop, P., & Fančovičová, J. (2010). Perceived body condition is associated with fear of a large carnivore predator in humans. *Annales Zoologici Fennici*, 47(6), 417-425.
- Prokop, P., & Fančovičová, J. (2013a). Does colour matter? The influence of animal warning colouration in human emotions and willingness to protect them. *Animal Conservation*, 16(4), 458-466.
- Prokop, P., & Fančovičová, J. (2013b). Self-protection versus disease avoidance. *Journal of Individual Differences*, 34(1), 15-23.
- Prokop, P., & Fančovičová, J. (2014). Seeing coloured fruits: Utilization of the theory of adaptive memory in teaching botany. *Journal of Biological Education*, 48(3), 127-132.
- Roth, W. M., Bowen, G. M., & McGinn, M. K. (1999). Differences in graph-related practices between high school biology textbooks and scientific ecology journals. *Journal of Research in Science Teaching*, 36(9), 977-1019.
- Rubens, P. (2002). *Science and technical writing: A manual of style*. Routledge, New York & London.
- Sanchez, C. A., & Wiley, J. (2006). An examination of the seductive details effect in terms of working memory capacity. *Memory & Cognition*, 34(2), 344-355.
- Schraw, G., & Lehman, S. (2001). Situational interest: A review of the literature and directions for future research. *Educational Psychology Review*, 13(1), 23-52.

- Simion, F., Regolin, L., & Bulf, H. (2008). A predisposition for biological motion in the newborn baby. *Proceedings of the National Academy of Sciences*, 105(2), 809-813.
- Soga, M., Gaston, K. J., Yamaura, Y., Kurisu, K., & Hanaki, K. (2016). Both direct and vicarious experiences of nature affect children's willingness to conserve biodiversity. *International Journal of Environmental Research and Public Health*, 13(6), 529.
- Souchet, J., & Aubret, F. (2016). Revisiting the fear of snakes in children: the role of aposematic signalling. *Scientific reports*, 6, 37619.
- Štefaniková, S., & Prokop, P. (2015). Do we believe pictures more or spoken words? How specific information affects how students learn about animals. *Eurasia Journal of Mathematics, Science & Technology Education*, 11(4), 725-733.
- Tolman, M. N., Hardy, G. R., & Sudweeks, R. R. (1998). Current science textbook use in the United States. *Science and Children*, 35(8), 22-25.
- Treves, A., & Naughton-Treves, L. (1999). Risk and opportunity for humans coexisting with large carnivores. *Journal of Human Evolution*, 36(3), 275-282.
- Treves, A., & Palmqvist, P. (2007). Reconstructing hominin interactions with mammalian carnivores (6.0-1.8 Ma). In: Nekaris, K. A. I. & Gursky, S. L. (Eds.), *Primate anti-predator strategies*. Springer, New York, USA, 355-381.
- Vollmeyer, R., & Rheinberg, F. (2006). Motivational effects on self-regulated learning with different tasks. *Educational Psychology Review*, 18(3), 239-253.
- Yorzinski, J. L., Penkunas, M. J., Platt, M. L., & Coss, R. G. (2014). Dangerous animals capture and maintain attention in humans. *Evolutionary Psychology*, 12(3), 534-548.

<http://www.ejmste.com>



For print copies of this issue or articles please send an e-mail to:

print@modestum.co.uk



The Effects of an Integrated Curriculum on Student Achievement in Saudi Arabia

Amani K. H. Alghamdi

Imam Abdulrahman Bin Faisal University (University of Dammam), SAUDI ARABIA

Received 23 May 2017 • Revised 29 June 2017 • Accepted 29 June 2017

ABSTRACT

This study examined the effects of an integrated mathematics and science curriculum with life-skills applications on academic achievement in a Saudi Arabian elementary school. An integrated unit was developed covering the grade 5 'sound and light' science unit and the 'perimeter, area, and size' mathematics unit, using practical applications activities connected to the students' everyday lives. The study involved treatment ($n = 36$) and comparison ($n = 41$) groups of grade 5 students (females) enrolled in a private school in Dhahran City. The comparison group was instructed using a conventional approach involving separate science and mathematics units, while the treatment group was instructed using the integrated unit. Two achievement tests for the target science and mathematics units were developed and used in the pretest-posttest design to verify the equivalence of the treatment and comparison groups before conducting the study, and to compare the achievement results after implementing the conventional and treatment units. The study found statistically significant differences favouring the treatment group on the achievement posttest (effect sizes were 0.44 for science and 0.49 for mathematics). These large effect sizes indicated the positive impact of using the proposed strategy of curriculum integration to evaluate the teaching program to see if the goal of improved achievement was actually realised.

Keywords: elementary, integrated curriculum, personally relevant pedagogy applications, science and mathematics integration, student achievement

INTRODUCTION

Education in the Kingdom of Saudi Arabia (KSA) is receiving an unprecedented level of attention (Alghamdi Hamdan, 2015). This trend is largely driven by the Saudi government's decision to embrace the science, technology, engineering, and mathematics (STEM) movement and to place these disciplines at the centre of educational development, with the ultimate objective of developing an internationally competitive, knowledge-based economy and thus reducing the country's dependence on the petroleum industry. Many initiatives have been undertaken since 2008 to achieve quality in science and mathematics education, including the King Abdullah bin Abdul Aziz Public Education Development Project, executed by the Tatweer Company (Alghamdi Hamdan, 2013). This attention is not exactly novel as for several decades various experts, such as Al-Ghanem (1999), have emphasised the need to reform Saudi science education and to reconsider the ways in which mathematics and science are taught (Jiffry, 2013).

Science and mathematics education provide an academic foundation for a vast number of scientific, technological, and industrial applications. This study focuses on the KSA's recent initiatives and explores a

© **Authors.** Terms and conditions of Creative Commons Attribution 4.0 International (CC BY 4.0) apply.

Correspondence: Amani K. H. Alghamdi, *University of Dammam, 946, 31932 Dharahan, Saudi Arabia.*

✉ akhalghamdi@uod.edu.sa

State of the literature

- The current literature had scarcely discussed how life skills can be part of science teaching.
- The current literature had not discussed an integration model of science and mathematics curricula
- There is some focus on science and mathematics PISA results in Saudi Arabia
- Adoption and usage of an integration model of multi disciplines has been marked with various barriers in relation to implementation.

Contribution of this paper to the literature

- To provide a recent initiatives and explores a purposefully designed strategy to integrate the science and mathematics curricula based on real-life applications.
- To adopt and use the model to teach mathematics and science at elementary level.
- To focus on the merits of integrating mathematics and science curricula.
- To explain the development and implementation of the grade-five curricula and reporting the results of this study in the KSA context

purposefully designed strategy to integrate the science and mathematics curricula based on real-life applications. It is assumed that grounding science and mathematics in students' daily life activities will improve students' achievement in these courses and will provide relevant connections among their component elements (Drake & Burns, 2004).

International concerns surrounding the advancement of STEM education have escalated in recent years and show no signs of abating; in this regard the case of Saudi Arabia is no exception (English, 2016). Sources (Caprile et al., 2015; Honey, Pearson & Schweingruber, 2014; Marginson et al., 2013; Prinsley & Baranyai, 2015; The Royal Society Science Policy Centre, 2014) have indicated that educators, policy developers, and business organisations are highlighting the urgency of improving STEM skills to meet current and future social, economic, and development challenges.

This article begins with a brief overview of the nature of an integrated curriculum and continues with a literature review focusing on the merits of integrating mathematics and science curricula. After describing the Saudi curriculum context and the recent government initiative to update the country's mathematics and science curricula, the article introduces a new theoretical framework pertaining to the standards and steps for the development of an integrated mathematics and science curriculum based on personally relevant pedagogy. After explaining the development and implementation of the grade-five curricula and reporting the results of this study, the paper concludes with a discussion of the implications of using an integrated curriculum for improving student achievement in the KSA context.

LITERATURE REVIEW

Integrated Curriculum

Conventional curricular arrangements present and teach subjects separately, with few connections with students' other courses. Mathematics students, for example, often ask questions like 'Why are we learning this?' as they struggle with the relevance of the course materials to their daily life and with the lack of connection with their other courses. One response to this legitimate concern is an integrated curriculum, which has been a topic of discussion since the mid-1900s (Drake & Burns, 2004; Sherbini & Tanawi, 2001).

An integrated curriculum augments stand-alone curricula by intermixing elements of subjects that are not normally combined (Loepp, 1999). This approach draws on the root of the word integration, which is 'integrate' (i.e., to make whole), and focuses on the benefits of integrating mathematics and science, a process that involves helping students make links between these disciplines and the students' world. According to Loepp (1999), successful curriculum integration should be 'relevant, standards based, and meaningful for students. At the same

time, the curriculum should challenge students to solve real-world problems' (p. 21). When students have an opportunity to focus on problems they feel are worth solving (i.e., that are relevant, authentic, and *real*), they are more motivated to learn (Drake & Burns, 2004). Loepp (1999) continued to state that integration can result in 'greater intellectual curiosity, improved attitude towards schooling, enhanced problem solving, and higher achievement' (p. 21).

Curriculum integration can vary in terms of degree and method. Drake and Burns (2004) identified the following degrees of integration: (a) through correlation teachers give casual attention to related materials in other subject areas; (b) the curriculum integrates sub-disciplines of a discipline, an example being science (biology, chemistry, and physics); (c) some teachers combine two subjects, called fusion (e.g., mathematics and science); (d) other teachers draw together a collection of skills, knowledge, and attitudes and infuse them into all subjects; and (e) full integration involves unifying the subject matter with students' life experiences. Curriculum designers can use thematic units (via learning centres), issues-based learning, inquiry-based learning, and problem-based learning as their underlying method of integration. Other examples include service learning (which connects students with their community via citizenship ethics) and the interdisciplinary approach. The latter organizes the curriculum around concepts and skills that are common to several disciplines, with the focus being on integration (and on associated overlaps) rather than on individual disciplines. Though challenging to coordinate, some schools try to sequence their course offerings so that the students study the same topic or issue concurrently in multiple subjects, an approach that is called parallel integration (e.g., the students learn about England in history, social studies, literature, and economics) (Allagani, 2003; Drake & Burns, 2004; Kurt & Pehlivan, 2013; Loepp, 1999). Another strategy is to organize the integration around approved learning outcomes for various subject areas (e.g., mathematics and science standards). In an era of accountability and outcomes-based learning, this approach to integration has to be balanced with the need to cover the standards and outcomes that are specific to each subject area. Finally, the trans-disciplinary approach depends on problems and concerns identified by the students. They develop personally relevant pedagogy as they apply what they have learned in real life, especially through project-based and inquiry-based learning (Allagani, 2003; Drake & Burns, 2004; Kurt & Pehlivan, 2013; Loepp, 1999).

A number of recent studies in science education and some monographs provide some recent and critical reviews of the literature on curriculum integration. Studies such as Rennie, Venville and Wallace (2012a) and Rennie, Venville and Wallace, (2012b) explore the value of STEM integration, especially in light of the trend for policy makers to follow the international trend towards greater emphasis on the STEM disciplines.

All of these efforts are oriented, in varying degrees of scope and intensity and in varying time frames, towards helping students *make connections* between what they are learning in school and in their daily life. The role of the teacher tends to be one of facilitator, co-planner, and co-learner, along with some combination of being a specialist and a generalist. The intensity of integration can range from a moderate level all the way up to a comprehensive paradigm shift. Even assessment strategies can change, evolving into a combination of traditional and authentic assessments, with activities striving in varying degrees for the integration of various disciplines' thinking, which can then be applied in real-world contexts (Drake & Burns, 2004).

Integrated Science and Mathematics Curricula

Loepp (1999) predicted 'the topic of integrated curriculum is destined to receive a lot of attention soon' (p. 25). In the era of curriculum reconstruction, considerable attention is being focused on curriculum integration (Davison, Miller & Metheny, 1995), especially in the mathematics, science, and technology education communities that are undertaking major reform initiatives in curriculum design, instructional approaches, and assessment practices. The adoption of an integrative approach to science and mathematics curricula is a natural response to the call for interdisciplinary approaches, including the removal of the disciplinary 'silos' in school curricula (Drake & Burns, 2004).

National standards. National standards for content, professional development, and assessment have been developed for mathematics, science, and technology education, especially in the US (International Technology Education Association, 2000; National Council of Teachers of Mathematics, 1989, 2000; National Research Council,

1996). The International Association of Science Teachers has proposed integration among the humanities (sociology, geography, history, philosophy, and law) and integration between the academic scientific subjects (science and mathematics). Such integration should be based on broad concepts/themes, which leads to more meaningful learning (National Science Teachers Association, 2004). The National Council of Teachers of Mathematics (2000) standards emphasise the importance of providing applications that are outside the traditional limits of mathematics. The National Science Education Standards (NSES) also emphasise the importance of providing learners with life applications based on the synergy of science with many other knowledge disciplines (Hatch & Smith, 2004).

Bosse et al.'s (2010) review of the international standards of science and mathematics education reveals that there is a broad similarity between both disciplines that requires concordance in their teaching. Both subjects seem to be equivalent in terms of their content and learning objectives, and this can be used as a basis for finding themes to bring about a more holistic integration of these disciplines. Davison, Miller and Metheny (1995) stated that "The "doing" of mathematics and the "doing" of science create a new way for students to look at the world that develops depth rather than breadth in mathematics' and science curricula" (p. 227).

Rationale for integration. The connections between science and mathematics were made more apparent by scientific developments that took into account the orientations of value and the digitisation theories of mathematics. Mathematics and science integration is justified for several reasons (Ibrahim, 2002; Lee et al., 2011; Merrill & Comerford, 2004; Obaid, 2004). First, mathematics can be characterised by a high degree of abstraction; thus, the integration of science with mathematics represents an opportunity to provide real-life examples of mathematical principles. Second, mathematical concepts can be effectively used during science teaching in order to make scientific concepts more meaningful. Third, both mathematics and science rely on concepts, axioms, functions, theories, and practice; thus, there is a significant degree of structural consistency that allows for integration. Fourth, life situations tend to be characterised by a high degree of flexibility, which means that it is possible to integrate the concepts of science and mathematics in a logical sequence. Finally, there is a strong link between mathematical and scientific reasoning and other types of thinking, particularly creative, critical, and deductive thinking (Ibrahim, 2002; Lee et al., 2011; Merrill & Comerford, 2004; Obaid, 2004).

Research examples of curriculum integration. Dessouky and Yousuf (1999) developed scenarios using a problem-solving methodology in their efforts to integrate science, mathematics, and technology in a public high-school curriculum. Berlin and White (2012) developed scenarios for the integration of science and mathematics, pointing out that technological applications can be combined with these subjects. Qandil (2001) attempted to verify the effectiveness of integrating science, technology, and sociology in order to improve the academic achievement and scientific culture of elementary school students. They taught two units that addressed social problems related to energy transfers. Their results confirmed the effectiveness of this strategy.

Afaneh and Al-Za'anin (2001) critiqued Palestinian curriculum-based mathematics and science courses separately as a basis for proposed scenarios to enrich the integration of mathematics and science. They argued that their approach respected a systemic orientation. Al-Mooji (2000) also verified the effectiveness of an integrated science unit on water in terms of improving the achievement and attitudes of elementary students towards science operations. Berry et al. (2004) found that curriculum integration based on the educational technology of geometric applications was effective in improving student achievement, specifically when integrating mathematics and science instruction. Marrongelle (2004) reported positive results from a program that convinced undergraduate students to adopt mathematics rules in physical applications. Their program also was effective in improving academic achievement. Bell and Garofalo (2005) found that conceptualised integration through the use of computer-based multimedia was effective in improving elementary students' achievement in science and mathematics. Similarly, Saleh and Othman's (2006) integrative problem-solving approach was effective in developing students' achievement.

Rationale for Separation

While there are many arguments for the integration of mathematics and science (Furner & Kumar, 2007), there are also arguments that focus on the differences between the disciplines and on reasons why they should not be integrated. Five types of science and mathematics integration (discipline specific, content, process methodological, and thematic) can be used in interdisciplinary curriculum development (Miller, Davison & Metheny, 1997). Moreover, some studies (such as Berlin & White, 2000) indicate that math and science integration should encourage teacher preparation to implement a new teaching strategy.

Real-life Applications

Underlying the foundation of this study is the idea that efforts to integrate mathematics and science curricula should hinge on relevance to real-life applications (Drake & Burns, 2004). Real-life applications are characterised by a high degree of flexibility and academic mobility that allows for the integration of more than one field of study (Al-Tamimi & Mustafa, 2011; Ammar, 2010). Because most real-world problems are multifaceted, people usually depend on more than one discipline in their daily dealings with these problems, especially when they use their own cognitive abilities in relation to life-application variables (Alhebsieh, 2011; Hamada, 2012).

Al-Rabat (2013) affirmed the effectiveness of life applications in the development of basic science skills in the field of mathematics education, including working effectively in groups, making effective oral and written presentations, and using computers well. Al-Qahtani and Abdul-Hamid (2010) found that life applications of economic concepts were effective in developing problem-solving skills and in reducing mathematics anxiety. Abu Al Hamael (2013) discovered that enrichment activities were effective for the development of personally relevant pedagogy in the field of science education. Moreover, according to Edutopia (2008), 'Integrated study is an extremely effective approach, helping students develop multifaceted expertise and grasp the important role interrelationships can play in the real world' (p. 23). Nevertheless, after conducting a study on integrating science and mathematics, Berlin and Lee (2005) observed that most integration attempts have focused on theoretical rather than on applied aspects.

Prior research confirms the importance of integrating science and mathematics from an instructional perspective. This research shows that curriculum integration has positive effects on the achievement of intended educational objectives. However, the efforts that are currently being made in terms of science and mathematics education in Saudi Arabia are strongly directed towards the separate development of each subject area. Currently, there is no concrete evidence of integration in the instruction of mathematics and science in KSA classrooms. All of the integration that is occurring is at the textbook level rather than at the operational level.

The Educational Context of the Kingdom of Saudi Arabia

Since the beginning of the new millennium, Saudi Arabia's public-school curricula have prioritised the teaching of science and mathematics. Despite the fact that international educational trends emphasise the importance of integrating science and math from an instructional perspective, the efforts that have been made in the KSA are aimed at developing each area separately. Saudi Arabia's current curriculum provides only limited opportunities to recognise the integration between elements of each study subject. This orientation makes it difficult to create a unified vision whereby curriculum planners and educators can break down the boundaries between science and math by proposing proven instructional strategies.

Recent KSA Mathematics and Science Educational Initiatives

The advantages and disadvantages of an integrated curriculum, especially for female students in the KSA, have not been widely discussed. Loepp (1999) concluded that the prospects for implementing any integrated curriculum on a nationwide basis (in the US) are bleak. But this does not have to be the case for Saudi Arabia. In 2006, the KSA reinforced its commitment to education through High Decree (No. 7544 / MB), (22/10/1427^h), which directs the Ministry of Education to implement curriculum development projects for math and natural science in collaboration with McGraw-Hill Education, an international educational publisher (Ghazanfar, 2012). Supported

Table 1. Saudi primary school curriculum (Al-Abdul Karim, 2009, p. 21; Ministry of Education, 2009 as cited in Alanazi, 2014)

	Subject Hours per week					
	Grade 1	Grade 2	Grade 3	Grade 4	Grade 5	Grade 6
Islamic studies	9	9	9	9	9	9
Arabic studies	12	9	9	9	8	8
Social studies	0	0	0	0	2	2
Art education	2	2	2	1	1	1
Science	1	1	2	2	3	3
Mathematics	2	4	4	5	5	5
Physical education	2	2	2	2	2	2

by the KSA government, the Ministry of Education and McGraw-Hill immediately began to modernise the KSA's science and mathematics curricula and methods of instruction (Al-Jazeera, 2011).

The project was launched in 2007, beginning with the textbooks and other educational materials for Grades 1, 4, 7, and 10. The materials for the remaining grades were gradually developed and implemented over the three subsequent years (Al-Jazeera, 2011). The foundations for designing and developing the mathematics and natural-science curricula were based on (a) international standards and (b) the most recent research focused on curriculum development, educational environments, and teachers and supervisors. Al-Humaidi (2009) explained that the project had three major dimensions: (a) the construction of advanced science and mathematics curricula in light of international standards, (b) the professional development of senior officials and teachers, and (c) the provision of support for teaching and learning processes while addressing the procedures implemented to ensure the quality of the educational materials.

General Observations on Mathematics and Science Teaching in Saudi Arabia

Table 1 profiles the public-school curriculum in the KSA, organised by separate subjects (Al-Abdul Karim, 2009; Ministry of Education, 2009 as cited in Alanazi, 2014). In particular, it highlights the fact that Islamic studies is allocated the largest number of hours of instruction per week while science and mathematics education receive among the fewest hours per week. Education in Saudi Arabia faces many challenges, including low test marks in mathematics and science. Out of 50 countries participating in the Programme for International Student Assessment (PISA) and Trends in International Mathematics and Science Study (TIMSS), eighth-grade Saudi students were ranked 43rd in mathematics and 39th in science (Barber, Mourshed & Whelan, 2007). Furthermore, Saudi students received low PISA and low TIMSS scores in both 2008 and 2015; in addition to this clear and obvious problem in math and science instruction, this unfortunate trend has not shown any improvement. Thus, the adoption of a novel approach is needed. In this regard, it is important to acknowledge that the heavy emphasis on Islamic studies in the curriculum does not create a barrier to expansion of mathematics and science instruction. After all, as Mansour (2011) explained, 'the Prophet's sayings take a pragmatic and utilitarian view of knowledge, which can be sought outside Islam if necessity demands it' (p. 303). The author agrees with this interpretation of the Hadith suggested by Mansour (2011) and Golshani (2007) and, in particular, with the view that science and mathematics are compatible with traditional Islamic beliefs.

The above-mentioned KSA government initiative to modernize the science and mathematics curricula is unfolding in a compelling educational context. Benefiting from years of experience as a science and mathematics educator in KSA, the author has observed that the textbooks only provide for superficial integration of science and mathematics. Moreover, mathematics and science teachers do not collaborate with each other and, as Al-Abdul Karim (2009) reported, most teachers' scientific and educational competencies are low. Their midterm and final tests tend to target lower-level learning (as per Bloom's taxonomy)—that is, remembering (knowledge) and understanding (comprehension). The tendency is for mathematics and science teachers to focus on memorization and to a lesser extent on comprehension.

This pedagogical approach serves only to inflate students' grades without the kind of learning that enables them to apply their knowledge in real-life situations. The weakness of this preparation means that Saudi students typically experience low achievement in mathematics and in the sciences at the university level. Their lack of readiness necessitates rigorous preparation in a preparatory year, which is a bridge year completed after high school and before university. Compounding the issue is the fact that most students develop an aversion to mathematics and science in high school relative to other subjects (Simmers, 2011). This is partially explained by most parents' prioritization of Arabic and Islamic studies.

Some teachers' comments indicate reference to high school (e.g., 'Mathematics and science teachers to not collaborate with each other'). However, in many instances, elementary teachers are generalists and the issue is not so much the lack of collaboration among discipline experts but instead the depth of knowledge and confidence of elementary-school teachers in any particular discipline, particularly in science and mathematics. Still, novice teachers would greatly benefit from collaborating with experienced teachers in terms of curriculum development and implementation.

RESEARCH QUESTIONS

This study was inspired by international trends in mathematics and science learning. Berlin and Lee (2005) observed that most attempts at mathematics and science integration have focused on theoretical aspects rather than on applied aspects. Life applications have not been extensively investigated as a common basis for the interdisciplinary teaching of science and mathematics. The focus in the KSA is on integration within each subject (intradisciplinary) rather than between subjects (interdisciplinary). This study proposes and evaluates an instructional strategy in the KSA context to integrate the teaching of science and mathematics based on life applications. The following research questions guided this study: How does an integrated science and mathematics unit based on life applications impact the learning achievements of female elementary-school students in the KSA? What are the strengths and weaknesses of an integrated science and mathematics unit based on life applications with regard to the learning achievements of female elementary-school students in the KSA?"

THEORETICAL FRAMEWORK

The first step in this study was to develop the theoretical framework. It was used to facilitate the development of the instructional unit and strategy to integrate science and mathematics teaching based on life-skills applications. Two lines of scholarly thought informed this framework: the studies that aim to integrate science and mathematics (Al-Mooji, 2000; Berlin & White, 2010; Bosse et al., 2010; Hassanein, 2003; Kurt & Pehlivan, 2013; Lee et al., 2013; Slough & Chamblee, 2007) and the studies that aim to employ life applications as a basis for the design of educational activities (Al-Qahtani & Abdul Hamid, 2010; Al-Rabani, 2011; Al-Shahat et al., 2012; Bouck, 2010; Fuchs et al., 2006; Hamada, 2012; Kliman, Mokros & Parkes, 2001; Mohammed, 2006; Mohammed, 2012). Given the framework developed around the design of the teaching and learning unit that was the focus of this study, some strategies were employed to address the author's inherent bias, such as the expertise of two university professors in math and science pedagogy. The units were also checked by school math and science supervisors on the male and female sides to ensure the rigour of the research before the tests were applied.

Mathematics, Science, and Female Students

Because this study targets the KSA's math and science curricula, we have focused on the advantages and disadvantages of an integrated curriculum for female students. Given the fact that the literature has not elaborated on females in particular and given the fact that, as a female researcher, I only have access to female schools because of the comprehensive policy of gender segregation in Saudi Arabia, I have decided to focus on female students.

Six Curriculum Integration Strategies

A set of six standards was developed to control the process of integrating science and mathematics teaching using life applications (see [Figure 1](#)).

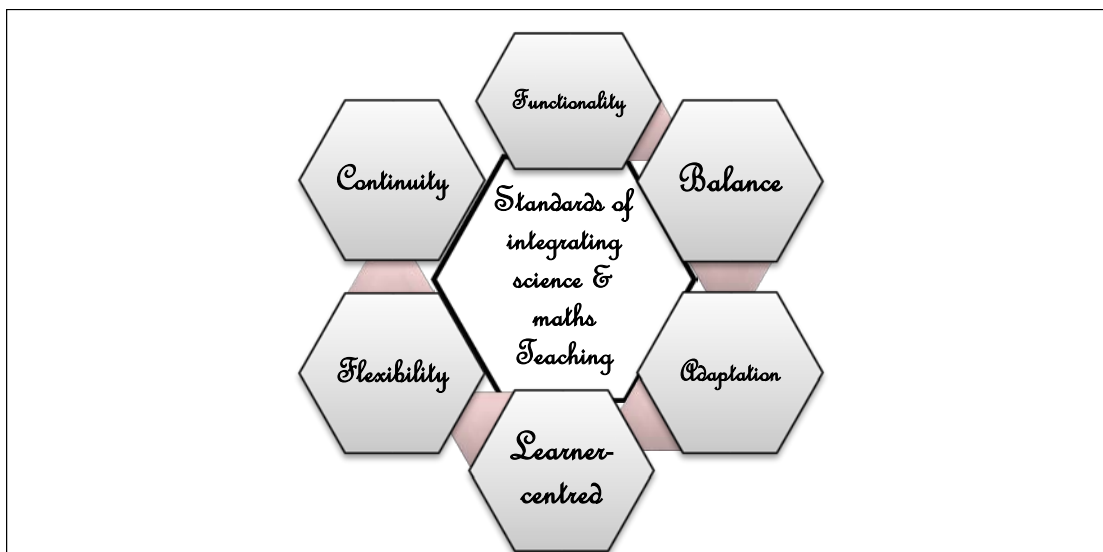

Figure 1. Standards for integrating science and math teaching based on life applications

Standard 1: Balance. The integration process should provide content for mathematics and science in equal measure. The balanced result is a general framework for presenting the integrated material, with other material more simply addressed as it comes up.

Standard 2: Adaptation. The integration of science and mathematics is based on life applications that are consistent with and relevant to students’ lives rather than being based only on the interdisciplinary links.

Standard 3: Learner-centred. Integrated teaching of science and mathematics requires that teachers use techniques for coordinating and linking the teaching processes. The resulting classroom experience must move away from teacher-centred approaches towards life-oriented and learner-centred activities anchored in integrated math and science that engage students.

Standard 4: Flexibility. Any life applications that are selected for the integration of science and mathematics teaching should be compatible with *both* disciplines, and should have a high degree of flexibility to conform to students’ life experiences.

Standard 5: Continuity. In order to maintain the motivation to learn, students should engage with math-science life applications encountered in class when outside the classroom.

Standard 6: Functionality. Any life applications and activities that are selected should consistently reflect the functional value of *both* science and mathematics. Both subjects should be integral and authentic aspects of students’ lives rather than being separate from their lives.

POWER Curriculum Integration Strategy

Using these six standards, the author proposes a strategy for integrating the teaching of science and mathematics based on life applications. This strategy is called POWER, an acronym that captures the following five stages (see **Figure 2**): planning, organisation, work-life activities, evaluation, and real activities. POWER means having the ability, strength, and capacity to work together to integrate these two disciplines for the students’ benefit. POWER refers to the feeling that one has the authority to do something—in this case, to actively create an integrated mathematics and science curriculum based on real-life applications. POWER also means that the teachers have the ability to influence the judgments and opinions of others—in this case, the students, other teachers, parents, administrators, and supervisors. By following the five stages of POWER, educators can make a difference in Saudi Arabia vis-à-vis students’ achievement in mathematics and science as it pertains to their daily lives.

1. P <i>Planning</i>	<ul style="list-style-type: none"> . Identify targets in science and mathematics disciplines. . Determine the life activities through which knowledge and skills of science and mathematics can be presented. . Determine the methods and materials needed for carrying out life activities.
2. O <i>Organization</i>	<ul style="list-style-type: none"> . Determine teaching roles to be carried out by teachers independently. . Determine co-teaching points between the science teacher and the math teacher. . Allocate the times of teaching activities inside the classroom. . Organize groups of students who will be taught using the integrated curriculum
3. W <i>Work life activities</i>	<ul style="list-style-type: none"> . Each teacher should extract skills and knowledge related to the science or mathematics lesson. . Each teacher should emphasize the strong relationship between using knowledge and skills in science and mathematics. . The two teachers should collaborate to present activities that stimulate students' thinking. . These activities should be based on life applications from students' environment and their practical experiences.
4. E <i>Evaluation</i>	<ul style="list-style-type: none"> . Each teacher should prepare and present each other's questions and assessment tools in order to ensure that the science <i>and</i> mathematics objectives are achieved.
5. R <i>Real activities</i>	<ul style="list-style-type: none"> . To ensure that the students have understood each field and to enhance the integral relationship between the two disciplines, the two teachers should instruct the students to carry out some real-life activities in the fields of science and mathematics.

Figure 2. Proposed five stages, using the six standards, for integrating science and mathematics teaching based on life applications

METHODOLOGY

The research design for this study involved several stages. First, the author formulated the above-mentioned set of standards and the POWER strategy for developing an integrated curriculum based on real-life applications. Using this model, the author developed an integrated math and science unit. This process involved validity checks with professors and then with experienced math and science teachers, as mentioned above. Once finalised, the author chose a school and teachers and students as participants, and then implemented the integrated unit using a two-group pretest-posttest design (comparison and treatment groups) with grade 5 students. Two groups received the integrated curriculum and two groups received traditional curricula (with all courses taught by the same two teachers). This process unfolded between the fall of 2014 and the spring of 2015.

Design of the Integrated Unit

An integrated mathematics and science unit was intended to break down the barriers that seem to exist between the teaching of the sciences and the teaching of mathematics. The author drew on the above-mentioned theoretical standards and POWER framework. This ensured (a) that the six standards for integration were adopted (balance, adaptation, learner-centrism, flexibility, continuity, and functionality) and (b) that the unit was developed using the POWER stages (planning, organisation, work-life activities, evaluation, and real-life activities).

This particular fifth-grade unit was organised to incorporate topics from the mathematics (circumference, area, and size) and science (sound and light) curricula. The major objective was to ensure that students would be able to appreciate the connections between the overlapping science and mathematics concepts while at the same time developing a deeper understanding of each of these disciplines. Attention was directed towards designing a set of activities that could serve as a common foundation for topics drawn from these units. The teachers were expected to deliver mathematics and science as one subject, amalgamated into one class period. A key component of the unit was a rationale for the teachers to share with the students, whereby they introduced the nature of the

Table 2. Overview of final version of the integrated mathematics and science unit

CONTENTS OF THE UNITS	
Lesson	Pages
First: Sound and Circumference	4–11
Second: Transmission of Sound and Area	12–20
Third: Light and Prisms	21–29
Fourth: The Reflection and Transmission of Light and the Size of Prisms	30–37

unit and provided justifications for integrating science and math, convincing them of the value of such integration. With a focus on personally relevant pedagogy, the unit contains activities and work sheets designed to enable the learners to record their initial thoughts about the activities, and then to express these thoughts to their teachers.

The penultimate version of the integrated unit was presented to four university faculty members specialising in teaching science and mathematics, as well as to six teachers. Their judgments confirmed the unit's content validity. Moreover, their input helped ensure that the unit reflected an appropriate balance between science and math content, had scientific integrity, and contained life applications and activities that were relevant to the content and target students. The final 40-page integrated unit is summarised in [Table 2](#) and is available from the author.

Sampling

The study was conducted in Dhahran, a large city located in the Eastern Province of the KSA. Several criteria were used to select the site for this study, including accessibility, university affiliation, and forward-thinking pedagogy. The site was selected because of its proximity to the author, which enabled repeated visits. The school was already associated with a university, thus making it more amenable to participating in a study. Pursuant to this, even though this school is mandated to follow the Saudi science and mathematics Al-Obiakan curriculum (translated from McGraw-Hill), it is one of the few schools that is trying to change its teaching and learning methods by moving beyond didactic learning towards a pedagogy based on critical thinking and problem-solving. The participating school is directed by a scientific committee appointed by the scientific council in the district. The school is known to be the first among all schools in the KSA (since 2008) to obtain the first rank on the national Standardised Aptitude Test and General Aptitude Test.

The school's participating educators comprised one math teacher (Teacher A), one science teacher (Teacher B), and the supervisors for each subject. The supervisors oversee math and science teaching in the school, and were involved in the event of any follow-up on the study's implementation. Teachers A and B collaborated to teach the integrated unit in Classroom A and Classroom B. Teacher A also taught her regular math class (Classroom C) and Teacher B taught her regular science class (Classroom D). The student sample comprised 162 female fifth-grade pupils. Four classes were assigned randomly: two classes for the experimental group, which received the integrated unit (n=76 students, 38 in each class), and two classes for the comparison group, which received the traditional curriculum (n= 86 students, 43 in each class).

Site Preparation

The author met with the four-member research group (teachers and supervisors) at the school six times, averaging 3 to 5 hours for each visit. During the first visit, the researcher collected information on how mathematics and science were taught at the school and more general information on teaching and learning at the school. All of the participants confirmed that they understood the importance of research and its relevance for improving the teaching and learning of science and mathematics. They discussed how the learning of answers is the predominant ethos of contemporary education, rather than the exploring of answers, which an integrated unit would allow. Additionally, ground rules were established during this meeting for the teachers to work together and to work with the researcher over the course of the study.

Table 3. Correlation coefficients for the sciences and mathematics test

Correlation coefficients for the items of the sciences test				Correlation coefficients for the items of the sciences test			
Item No.	Correlation Coefficient	Item No.	Correlation Coefficient	Item No.	Correlation Coefficient	Item No.	Correlation Coefficient
1	0.88**	11	0.75**	1	0.83**	11	0.83**
2	0.81**	12	0.74**	2	0.79**	12	0.79**
3	0.75**	13	0.83**	3	0.81**	13	0.81**
4	0.84**	14	0.79**	4	0.84**	14	**0.80
5	0.81**	15	0.81**	5	0.81**	15	0.84**
6	0.72**	16	0.80**	6	0.72**	16	0.81**
7	0.86**	17	0.84**	7	0.86**	17	0.75**
8	0.83**	18	0.81**	8	0.83**	18	0.84**
9	0.74**	19	0.77**	9	0.84**	19	0.81**
10	0.79**	20	0.81**	10	0.79**	20	0.72**

According to the table above, it is clear that all the correlation coefficients are statistically significant at the significance level of (0.05) and ranged for the mathematics test from 0.74 to 0.86, while they ranged for the sciences test from 0.72 to 0.86. These indicators, in addition to the reliability coefficient, give a significance that both tests are reliable and can be practically applied.¹

During the second meeting, the author explained the experimental research design protocol and shared the rationale for integrating mathematics and science, while drawing on the literature review:

- There is a strong historical relationship between the sciences and mathematics. This can be seen in the fact that the sciences did not achieve rapid progress until they adopted the quantitative approach and began to rely heavily on mathematical equations.
- There is considerable similarity between the structure of the sciences and the structure of mathematics, in terms of the use of axioms, facts, relations, principles, and theories.
- The sciences are a fruitful arena for illustrating the applications of mathematics because mathematics is usually presented in abstract terms by emphasising principles, theorems, and exercises that are not necessarily related to reality in an obvious way.
- Mathematical concepts can be employed in the process of teaching the sciences, thus making mathematical concepts more tangible and meaningful for the learner.
- There exist many life situations and applications in which *both* mathematics and the sciences can make valuable contributions.
- There is convergence in the thinking activities used when teaching mathematics and the sciences, especially in relation to induction, deduction, and inference drawing.

The two teachers received an explanation of the experiment and its objectives, information about cooperating in presenting the activities, a presentation of the unit's academic content, and information about exchanging their respective teaching roles, as shown in [Table 3](#).

In the third meeting, the educators and the author discussed in more detail the ways in which the unit would be taught and in which the students would be introduced to this new methodology. Both teachers remained committed but were a little concerned about the students' reactions to mathematics and science being taught during the same class period and about having both teachers together in the same classroom for the first time. In the fourth

¹ Achievement test for the unit of (circumference, area and volume) Annex No. (2), and achievement test for the unit of (sound and light), Annex No. (3).

meeting, the research group sorted out an issue between the two teachers about the difference in teaching time between math and science. Though addressed during an earlier meeting, this issue came up because of the mathematics teacher's concern about losing class time to science.

Pretest and Posttest

The author prepared two tests, one for the mathematics perimeter, area, and volume unit, and one for the science sound and light unit. The mathematics test contained a 12-word vocabulary assessment, and the science test contained a 20-word vocabulary assessment. In the multiple-choice test, the students were offered four options. Although one might think that multiple-choice tests are contrary to the development of critical-thinking skills as prioritised by the author and as targeted through subject integration, the questions were constructed and checked in such a manner as to assure the integration of the critical-thinking component (sample questions such as in Appendix 1). The initial content of the two tests was presented for verification to the same four science and math teachers who vetted the integrated unit, in addition to the same six teachers who vetted the scientific and linguistic suitability of the vocabulary and its relationship with the content. Vocabulary adjustments were made based on their feedback. During the second semester of the 2014-2015 school year, the amended instruments were pilot tested with 25 students in the female section of the private school. Cronbach's alphas revealed internal consistency coefficients of 0.84 for the math test and 0.89 for the science test. These results indicate the reasonable validity and consistency of the pretest and posttest instruments and their applicability to the participating students.

Data Collection

During the fourth meeting with the research group, all 162 students received the pretest (both the treatment and comparison groups), prefaced with an explanation of its purpose to capture their feelings about and understandings of the unit's content. After administering the pretest, the author observed the teachers teaching the integrated and traditional units for two weeks. Each class was observed five times. After each observation, the author shared with the supervisors all of the points observed (recorded in field notes) and all of the materials collected in the sessions. At the end of the unit, the posttest was administered to both the comparison groups and the treatment groups.

Amendments while implementing the experiment. Early into the implementation of the integrated units, the teachers experienced some time-tabling difficulties. The number of weekly science classes ($n=3$) was lower than the number of math classes ($n=5$). This issue was resolved with the help of the supervisors and the school administration, who arranged for the math and science periods to be amalgamated and the activity time followed the class time. This created four sessions for content and four sessions for life-based learning ($n=8$ periods). The comparison group's schedule did not change, with five periods for math and three for science.

At the beginning of the experiment, when implementing the integrated unit, the teachers met before each lesson in order to agree on plans for presentations, on the roles of each teacher, and on how to proceed with presenting the topics. At the beginning of the experiment, students needed a lot of stimulation and encouragement from their teachers to participate in the activities. They also needed continuous monitoring and control during their life-based group activities, perhaps because Saudi female students are not familiar with group activities. The students eventually described it as an interesting educational approach and a useful learning experience.

Data Analysis

The data were analysed using inferential statistics, specifically t-tests, to explore any differences between the comparison and treatment groups (Sprinthall, 2001). A t-test assesses whether the means of two groups are statistically different from one other. This analysis is appropriate whenever one is comparing the pretest and posttest means of two small groups.

Table 4. Results of value T in pre- and post-test of the sound and light unit (science content)

Science pre-test						
Group	No.	Mean	S. Deviation	D. F.	t Value	p
Control	41	2.0732	1.36730	75	0.693	0.490
Experimental	36	2.2500	0.73193			
Science post test						
Group	No.	Mean	S. Deviation	D. F.	t Value	p
Control	41	11.3902	1.20162	75	7.704	0.000
Experimental	36	14.0833	1.42177			

Table 5. Value T pre- and post-test results for perimeter, area and volume unit (mathematics content)

Mathematics pre-test						
Group	No.	Mean	S. Deviation	D. F.	t Value	p
Control	41	2.0488	0.63052	75	1.076	0.285
Experimental	36	2.2778	1.18590			
Mathematics post test						
Group	No.	Mean	S. Deviation	D. F.	t Value	p
Control	41	8.9756	1.27452	75	8.569	0.000
Experimental	36	10.02817	1.02817			

RESULTS

This study involved (a) the development of a theoretical framework (standards for integration) and a strategy for developing integrated units, (b) the development and validation of an integrated science and mathematics unit based on life applications, and (c) an experimental research design (experiment/control, pre/post test) to measure the effectiveness of the proposed integrated strategy in terms of improving students' achievement in science and math. In the pretests the groups performed similarly on math and science knowledge. There was a significant difference ($p < 0.01$) between the posttest science scores of the treatment and comparison groups in favour of the former. The t-value was 7.704, $df = 75$ (see [Table 4](#)). The effect size was calculated in terms of η^2 for t-value ($\eta^2 = \frac{t^2}{T + 2 + allowance}$). The value of η^2 was (0.44), which is greater than 0.14; this confirms that the experimental group outperformed the control group on the posttest. This is a medium effect size. [Table 4](#) explains that.

In addition, there was a significant difference ($p < 0.01$) between the posttest math scores of the treatment and comparison groups in favour of the treatment group. The t-value was 8.569 ($df = 75$). The effect size was 0.49, which is a small effect size. This confirms that the treatment group benefited more than the comparison group. [Table 5](#) explains that

DISCUSSION

The results of the current study indicate statistically significant differences between the treatment group and the comparison group on the tests for the perimeter, area, and volume (mathematics) unit and for the sound and light (science) unit. In effect, the students taking the integrated units received higher scores than those in the comparison group, who took separate mathematics and science units. Thus, the integrated curriculum based on life applications improved the students' achievement in both subjects. Several factors can explain this success. The integrated teaching strategy linked the female students' life experiences with the academic content of the science and mathematics unit. These linkages served to convince students of the functional value of both science and mathematics.

The life-based learning activities required students to think about what they were learning. The success of this strategy is reflected in the students' improved posttest scores. The proposed strategy also focused on a learner-centred approach, which usually results in better academic attainment, as it provides the learner with more independence. This proved to be the case in this study. Anecdotal evidence revealed that the students were receptive to the experience and to the teaching team of science and mathematics teachers. This is further reflected in the higher scores of the treatment-group students relative to the comparison-group students. The results indicate that the magnitude of the impact of the proposed strategy on academic achievement in mathematics and science was substantial. The effect size for mathematics was (0.49), greater than the impact on science of (0.44).

These results indicate that the impact of the proposed strategy is greater in mathematics than in science. The author believes that such an outcome could reasonably be expected when conducting the experiment based on the fact that the teaching of mathematics in the traditional way is characterised by a higher degree of abstraction than the teaching of science, which is more closely related to concrete examples and real-life applications. Therefore, the teaching of mathematics has the advantage in the current study as the process of integration convinced the students of the functional value of mathematics.

The results of this study are consistent with those of previous studies (Al-Mooji, 2000; Bell & Garofalo, 2005; Berlin & White, 2010; Berry et al., 2004; Hassanein, 2003; Marrongelle, 2004; Qandil, 2001; Saleh & Othman, 2006), which indicated that integrating the teaching of science and mathematics leads to improved academic achievement relative to teaching them separately. The treatment group's mean scores on the posttest were higher than those of the comparison group for both subjects, though this was more the case for science than for mathematics. One of the possible reasons why the science section benefited more than the mathematics section could be due to the confidence level of the teachers. Moreover, the results of the study are consistent with previous studies demonstrating that reliance on life applications in designing integrative teaching activities positively affects student achievement (Al-Qahtani & Abdul Hamid, 2010; Al-Rabani, 2011; Al-Rabat, 2013; Al-Shahat et al., 2012; Bouck, 2010; Fuchs et al., 2006; Hamada, 2012; Kliman et al., 2001; Mohammed, 2006). Berlin and Lee (2005) observed that most integration attempts have focused on theoretical or technological aspects rather than on applied aspects. This study privileged life applications over content, viewing the former as tools for teaching the latter. This study benefitted from the application of a new framework with specific steps for science and mathematics teachers when designing and delivering an integrative curriculum based on life applications. The author believes that these applications represent a broader scope for integration, which at the same time are compatible with modern learner-centred and active-learning educational approaches.

While the treatment group had higher scores on both tests, all students scored higher on their science test than on their math test. Interestingly, the difference was larger between subjects for the treatment group than for the comparison group. The treatment group's mean score was 10 for math and 14 for science (a 4 point difference). The comparison group's mean score was 8.9 for math and 11.3 for science (a 2.4 point difference); these were raw posttest means. It seems that the students who took the integrated unit experienced a wider gap between their test scores on the two topics.

Limitations

This study was limited to one school and one grade level. The Ministry of Education and/or other researchers need to implement this study in a wider range of schools to provide a real opportunity to judge the results of integrating science and mathematics instruction. Detailed studies also need to be conducted on designing teaching units based on the proposed POWER strategy for other subjects like, for example, Arabic language, history, and Islamic studies.

Recommendations

The results of this study have several compelling implications. The designers of science and mathematics curricula should provide clear plans to teachers on how to integrate various academic topics. Teachers and authors of educational programs should be directed to use the proposed POWER strategy for the teaching of science and

mathematics. Designers of teacher-training programs should focus on teaching techniques that use integration strategies. Supervisors in various educational fields could work on the expansion of academic cooperation among teachers as a part of performance assessment. Teachers can be encouraged to work in pairs to ensure the success of integration initiatives. University teacher-education programs should instruct pre-service teachers on the skills involved in integrating the teaching of various disciplines, especially as the status quo largely focuses on specialisation. The Ministry of Education could organise competitions for teachers and schools around initiatives to integrate the teaching of various disciplines. The study results support the following recommendations:

- Provide an instructional proposal to be used by teachers of science and mathematics when presenting their daily pre-planned integrative lessons;
- Provide an integrative science and math unit to be used as a model for future attempts to integrate the teaching of science and math, especially at the elementary level;
- Propose life-based situations and activities that can be integrated in a practical way;
- In order to achieve the common goals of the two subjects, support the plans of science and mathematics developers for vertical and horizontal integration;
- Sensitise the designers of professional-development programs to the need to create relevant instructional programs focused on integrating subjects; and
- Provide a professional mechanism that contributes to more effective professional communication between science and mathematics teachers.

CONCLUSION

Over the last five years, science and mathematics education in the KSA has attracted considerable attention from policymakers and educators. To some extent, this interest emerged in the wake of Saudi students' low PISA and TIMSS scores in 2008 and 2015. The current study is an attempt to employ a new methodology for integrating science and mathematics teaching in elementary classrooms by integrating scientific and mathematics concepts as opposed to teaching the two subjects separately. Treatment-group students' pretest and posttest results showed significant improvements in academic achievement on targeted learning outcomes. This is consistent with Davison et al.'s (1995) finding that '...integration will provide for a more reality-based learning experience' (p. 229). This study affirms that math and science integration yields positive outcomes. Reforming the KSA's math and science curricula in an integrative manner would improve test results, especially when instruction is grounded in real-life applications.

REFERENCES

- Abu Al Hamael, A.B. (2013). Faleat Barnamaj Ithraii fe Aloloum letenmeat Almaharat Alhayatia lada Talameth Alsaf Alsades Alebtetadai Bemohafathet Jeddah (Effectiveness of a program in science for the development of personally relevant pedagogy for grade six students in Jeddah). *Journal of the College of Education (Banha University)*, 24(93), 111-182.
- Afaneh, I., & Za'anin, J. A. (2001). Ethraa Moqararai Alryadiat wa Aloloum lessaf Alsades Elebtetadai fi Felesteen fi dhaw Aletejah Almandhomi (Enrich math and science for sixth-grade primary students in Palestine in the light of the systemic trend). Paper presented at the Fifth Scientific Conference of Science Education, Alexandria, Egypt.
- Al-Abdul Karim, R. (2009). *Altaleam alam fe alsaudia: almoskelat maroofa wa alhelool motaha. (Saudi public education: The problems are known and the solutions available... but?)*. Retrieved from http://www.almarefh.net/show_content_sub.php?CUV=364&SubModel=13&8ID=507
- Alanazi, F.H.F. (2014). *Between science and place: Saudi children's ideas of the Earth* (unpublished doctoral dissertation). Aberdeen, United Kingdom: University of Aberdeen.
- Alghamdi Hamdan, A. (2013). The road to culturally relevant pedagogy: Expatriate teachers' pedagogical practices in the cultural context of Saudi Arabian higher education. *McGill Journal of Education*, 49(1), 201-226.
- Alghamdi Hamdan, A. (2015). Reforming higher education in Saudi Arabia: Reasons for optimism. In J. Willoughby & F. Badri (Eds.), *Higher education in the GCC* (pp. 20-33). Dubai, UAE: Springer.

- Al-Ghanem, G. S. D. (1999). *Reforming science education in Saudi Arabia: A conceptual framework for the design of a coordinated and thematic science (CATS) module for grades 7-9* (unpublished doctoral dissertation). Morgantown, WV: University of West Virginia.
- Alhebsieh, Z. (2011). AlEtejahat Alhadetha fe taleam Almaharat Alhayatia wa toroq tadresaha wa Dawraha fe benaa shakhseat Altaleb (modern trends and methods in teaching personally relevant pedagogy and their role in building the student's personality). *Journal of Educational Development (Oman)*, 9(63), 32-35.
- Al-Jazeera. (2011). *Issue 13892: Tatweer Manaheg Alreadiat wa Aloloum Fekrah wa Albedayat (The development of mathematics and science curricula: The idea and the beginnings)*. Retrieved from <http://www.aljazeera.com/programmes/science-in-a-golden-age>
- Allagani, A. H. (2003). *Almanhaj (Alossos - Almokawenat - Altanthemat) (Curriculum: Fundamentals, components and regulations)*. Cairo, Egypt: Alam Al Kutub.
- Al-Mooji, A. M. (2000). Wehdat Almawdow Kamehwar Leltakamol fe Manahej Aloloum Belmarhala Aleddadia (Unity of subject as a basis for integration in middle school science curriculum). *Fourth Conference on Scientific Education, Al Ismailia*, 28(1), 23-38.
- Al-Qahtani, O. A., & Abdul Hamid, N. (2010). An integrated program of mathematics based on the inclusion of some economic concepts and its impact on the development of skills to solve familiar and unfamiliar verbal problems of life familiar and reducing math worries among primary fourth grade pupils. *Journal of Psychological and Educational Research*, 25(2), 260-291.
- Al-Rabani, A. H. (2011). Arab and international experiences in teaching personally relevant pedagogy. *Journal of Educational Development (Oman)*, 9(63), 44-47.
- Al-Rabat, B. S. I. (2013). Faleat Barnamej Mogtrah qaim Alaa Anshetat Alreadyat Alhayatia fe Tanmyat Maharat Amalyat Al Elm Alassasia lada Talameeth Alsaf Althaleth Alebtedaie (The effectiveness of a proposed program based on mathematical life activities in developing basic learning skills of grade 3 pupils). *Journal of Education*, 16, 153-189.
- Al-Shahat, D., Al Badawi, A., Faiz, M. A., & Abdel-Fattah, H. (2012). Effectiveness of the learning strategy based on developing personally relevant pedagogy in science (among primary fifth grade pupils). *Journal of the College of Education in Port Said*, 1, 366-386.
- Al-Tamimi, N., & Mustafa, N. A. (2011). Schools of building and development of personally relevant pedagogy in the Kingdom of Saudi Arabia for the 21st century. *Studies in University Education*, 22, 197-268.
- Ammar, S. (2010). Incorporation of some contemporary personally relevant pedagogy in the primary education curriculum. *The Message of Education (Oman)*, 29, 64-77.
- Barber, M., Mourshed, M., & Whelan, F. (2007). *Improving education in the Gulf*. Dubai, United Arab Emirates: McKinsey & Company.
- Bell, R., & Garofalo, J. (Eds.). (2005). *Curriculum series: Science units for grades 9-12*. Eugene, OR: International Society for Technology in Education (ISTE).
- Berlin, D., & Lee, H. (2005). Integration of science and mathematics education: Historical analysis. *School Science and Mathematics*, 105(1), 15-24.
- Berlin, D. F., & White, A.L. (2000). *An innovative integrated mathematics, science, and technology education teacher certification program*. Columbus, OH: Ohio State University.
- Berlin, F., & White, L. (2010). Preservice mathematics and science teachers in an integrated teacher preparation program for grades 7-12: A 3-year study of attitudes and perceptions related to integration. *Int'l Journal of Science and Mathematics Education*, 8(1), 97-115.
- Berry, J. S., Burghes, D.N., Huntley, I. D., James D. J. G., & Moscardini, A. O. (Eds.) (2004). Mathematical modelling courses (pp. 51-57). Chichester, UK: Ellis Horwood.
- Berlin, F., & White, L. (2012). A longitudinal look at attitudes and perceptions related to the integration of mathematics, science, and technology education. *School Science and Mathematics*, 112(1), 20-30.
- Bosse, J., Lee, D., Swinson, M., & Faulconer, J. (2010). The NCTM process standards and the five "Es" of science: Connecting math and science. *School Science and Mathematics*, 110(5), 262-276.

- Bouck, C. (2010). Reports of personally relevant pedagogy training for students with intellectual disabilities in and out of school. *Journal of Intellectual Disability Research*, 54(12), 1093–1103.
- Caprile, M., Palmen, R., Sainz, M., & Dente, G. (2015). Encouraging STEM studies for the labour market. Brussels: Directorate-General for Internal Policies, European Parliament.
- Davison, D. M., Miller, K. W., & Metheny, D. L. (1995). What does integration of science and mathematics really mean? *School Science and Mathematics*, 95(5), 226–230.
- Dessouky, E. A., & Yousuf, M. A. (1999). *An outlook for the integration of science, mathematics and technology in public high schools' curriculum with the prospects for 2020*. Cairo, Egypt: National Centre for Educational Research and Development.
- Drake, S. M., & Burns, R. C. (2004). *Meeting standards through integrated curriculum*. Alexandria, VA: Association of Supervision and Curriculum Development.
- Edutopia. (2008). *Why should schools embrace integrated studies? It fosters a way of learning that mimics real life*. Retrieved from <http://www.edutopia.org/integrated-studies-introduction>
- English, L. D. (2016). STEM education K-12: Perspectives on integration. *International Journal of STEM Education*, 3(3) 1–8.
- Furner, J. M., & Kumar, D. D. (2007). The mathematics and science integration argument: A stand for teacher education. *Eurasia Journal of Mathematics, Science & Technology Education*, 3(3), 185–189.
- Fuchs, L. S., Fuchs, D., Finelli, R., Courey, S. J., Hamlett, C. L., Sones, E. M., & Hope, S. K. (2006). Teaching third graders about real-life mathematical problem solving: A randomized controlled study. *Elementary School Journal*, 106(4), 293–312.
- Ghazanfar, A. K. (2012). McGraw-Hill Education unveils expansion plans. *Arab News*. Retrieved from <http://www.arabnews.com/node/411038#>
- Golshani, M. (2007). Science for humanity: An Islamic perspective. *Islam and Science*, 5(2). Retrieved from http://findarticles.com/p/articles/mi_m0QYQ/is_2_5/ai_n21119039/
- Hamada, S. A. (2012). Personally relevant pedagogy development programs. *Al Qiraa wal Maarifa Magazine*, 132, 182–200.
- Hassanein, B. M. (2003). A program of nutrition based on the method of integration and its impact on the development of knowledge attainment and nutrition awareness at the fourth year students of literary sections in Sohag Faculty of Education. *Journal of Science Education*, 6(1), 37–84.
- Hatch, G., & Smith, D. (2004). Integrating physical education, math, and physics. *Journal of Physical Education, Recreation & Dance*, 75(1), 42–50.
- Honey, M., Pearson, G., & Schweingruber, A. (2014). *STEM integration in K-12 education: Status, prospects, and an agenda for research*. Washington, DC: National Academies Press.
- Ibrahim, M. A. (2002). *Educational curriculum perspectives in the knowledge society*. Cairo, Egypt: A'alam Al Kutub.
- International Technology Education Association. (2000). *Standards for technological literacy: Content for the study of technology*. Reston, VA: Author.
- Jiffry, M. F. (2013). Saudi schools lack quality science and math teaching. *Arab News*. Retrieved from <http://www.arabnews.com/news/458491>
- Kliman, M., Mokros, J., & Parkes, A. (2001). *Putting math into family life: What's possible for working parents?* Eric Database, ED (480010).
- Kurt, K., & Pehlivan, M. (2013). Integrated programs for science and mathematics. *International Journal of Education in Mathematics, Science and Technology*, 1(2), 116–121.
- Lee, M., Chauvot, J., Plankis, B., Vowell, J., & Culpepper, S. (2011). Integrating to learn and learning to integrate: A case study of an online master's program on science-mathematics integration for middle school teachers. *Internet and Higher Education*, 14(3), 191–200.
- Lee, M., Chauvot, J., Vowell, J., Culpepper, S., & Plankis, B. (2013). Stepping into iSMART: Understanding science-mathematics integration for middle school science and mathematics teachers. *School Science and Mathematics*, 113(4), 159–169.

- Loepp, F. L. (1999). Models of curriculum integration. *Journal of Technology Studies*, 25(2), 21–25.
- Mansour, N. (2011). Science teachers' views of science and religion vs. the Islamic perspective: Conflicting or compatible? *Science Education*, 95(2), 281–309.
- Marginson, S., Tytler, R., Freeman, B., & Roberts, K. (2013). *STEM: Country comparisons*. Melbourne, Australia: Australian Council of Learned Academies
- Marrongelle, K. (2004). How students use physics to reason about calculus tasks. *School Science and Mathematics*, 104(6), 258–272. doi: 10.1111/j.1949-8594.2004.tb17997.x
- Merrill, C., & Comerford, M. (2004). Technology and mathematics standards: An integrated approach. *The Technology Teacher*, 64(2), 8–12.
- Miller, K., Metheny, D., & Davison, D. (1997). Issues in integrating mathematics and science. *Science Educator*, 6(1), 16–21.
- Mohammed, H. (2006). *Using life applications in teaching to make mathematics more appealing to fifth grade children* (unpublished master's thesis). Cairo, Egypt: Ain Shams University.
- Mohammed, S. A. M. (2012). Multimedia effectiveness in the development of concepts of life for kindergarten children. *Al Qira'a wal Ma'arifa Magazine*, 129, 204–235.
- National Council of Teachers of Mathematics. (1989). *Curriculum and evaluation standards for school mathematics*. Reston, VA: Author.
- National Council of Teachers of Mathematics. (2000). *Principles and standards for school mathematics*. Reston, VA: Author.
- National Research Council. (1996). *National science education standards*. Washington, DC: National Academy Press.
- National Science Teachers Association. (2004). Promoting fair and equitable assessments: A position statement of the National Council for Social Studies. *Social Education*, 68(4), 290.
- Obaid, W. (2004). *Teaching mathematics for all children*. Amman, Jordan: Dar Al Maysara.
- Prinsley, R., & Baranyai, K. (2015). STEM skills in the workforce: What do employers want? *Occasional Papers Series, issue 9, March*. Office of the Chief Scientist.
- Qandil, A. I. (2001). The impact of the integration of science, technology and society in the scientific culture and academic achievement in science for students in the fifth grade. *Journal of Science Education*, 4(1), 79–119.
- Rennie, L., Venville, G., & Wallace, J. (2012a). *Integrating science, technology, engineering and mathematics: Issues, reflections and ways forward*. New York: Taylor & Francis.
- Rennie, L., Venville, G., & Wallace, J. (2012b). *Knowledge that counts in a global community: Exploring the contribution of integrated curriculum*. London: Routledge.
- Saleh, M., & Othman, I. (2006). The effectiveness of the integrated approach based on solving the problems of attainment in science and math and the motivation to accomplish among pupils of various attainment levels in primary school pupils. *Journal of the College of Education in Port Said*, 1(Dec), 163–227.
- Sherbini, F., & Tanawi, E. (2001). *Global approaches in the development of educational curricula*. Cairo, Egypt: The Anglo-Egyptian Library.
- Simmers, M. (2011). *It's Not the Math They Hate Math Education*. Paper presented at the 2011 HUIC– Hawaii University International Conferences on Mathematics and Engineering, Ala Moana Hotel, Honolulu Hawaii, USA.
- Slough, W., & Chamblee, E. (2007). Technology as an innovation in science and mathematics teaching. *School Science and Mathematics*, 107(6), 222–224.
- Sprinthall, R.C. (2011). *Basic statistical analysis*. New York: Pearson.
- The Royal Society Science Policy Centre. (2014). *Vision for science and mathematics education*. London: The Royal Society.

APPENDICES

Appendix 1

Achievement Test for the Sound and Light Unit for Grade 5 Students

Dear students, **peace** be upon you;

The test at hand is on the sound and light unit. You are required to:

1. Register your information in the required fields on the answer sheet attached to the test;
2. Start to answer after the teacher requests that you do so;
3. Answer all the test questions, of which there are 20 in total;
4. Answer the questions by choosing only one option from the three options provided with each question;
5. Remember that there is only one correct answer to each question;
6. Highlight your answer on the answer sheet by putting a circle around the number for the correct answer (see the example below); and
7. Remember that the maximum time for answering the test questions is 60 minutes.

Best of luck!

Question Number	Options		
	1	2	3

Answer Sheet

Main Information			
Name:	School:	Class:	
Date:	Period:	Teacher's Name:	
Question Number	Options		
1	1	2	3
2	1	2	3
3	1	2	3
4	1	2	3
5	1	2	3
6	1	2	3
7	1	2	3
8	1	2	3
9	1	2	3
10	1	2	3
11	1	2	3
12	1	2	3
13	1	2	3
14	1	2	3
15	1	2	3
16	1	2	3

17	1	2	3
18	1	2	3
19	1	2	3
20	1	2	3

Question No. (1)	The series of compressions and rarefactions transmitted through a certain type of matter is
1	a medium
2	sound
3	sound waves
Question No. (2)	An area where there are approximately no particles of matter is ...
1	composed of sound waves
2	a vacuum
3	a medium
Question No. (3)	The speed of sound is at its highest possible level in matter.
1	Solid
2	liquid
3	gaseous
Question No. (4)	Sound energy is transmitted because of
1	repulsion between the particles of the medium
2	conflicts between the particles of the medium
3	Attraction between the particles of the medium
Question No. (5)	One of the following statements is correct:
1	Cold air transmits sound more quickly than warm air.
2	There is no difference between cold and warm air in terms of its effect on the speed of sound.
3	Warm air transmits sound more quickly than cold air.
Question No. (6)	An echo involves
1	repeatedly hearing a sound because of the reflections of the sound waves
2	the retraction of surface waves away from some surface
3	the absorption of sound energy
Question No. (7)	Frequency is defined as the number of times that a certain body vibrates during
1	one minute
2	two seconds
3	a known time
Question No. (8)	One of the following statements is correct:
1	The frequency of a tender voice is high while the frequency of a coarse voice is low.
2	The frequency of a coarse voice is high while the frequency of a tender voice is low.
3	The frequency of a coarse voice is the same as that of a tender voice.
Question No. (9)	We can increase the frequency of sound by moving

1	in random directions
2	in a direction that is opposite to the direction of the sound
3	in the same sound direction
Question No. (10)	One of the apparatuses that scientists developed from the idea of the sound echo is
1	the thermometer
2	sonar
3	the anemometer
Question No. (11)	Length of a light wave is the distance between
1	the top and the bottom
2	two successive wave tops
3	five successive wave tops
Question No. (12)	The speed of a wave is calculated by
1	adding the wave length to its frequency
2	multiplying the wave length by its frequency
3	dividing the wave length by its frequency
Question No. (13)	The photon is the smallest part of energy. It exists independently.
1	sound
2	light
3	thermal
Question No. (14)	Which of the following is considered to be a semi-transparent body?
1	plastic
2	wood
3	glass
Question No. (15)	The length of shade depends on
1	the quantity of rays falling on the body
2	the inclination of the rays falling on the body
3	the type of rays falling on the body
Question No. (16)	We see a body when the light from it into our eyes.
1	is reflected
2	is refracted
3	inclines
Question No. (17)	A reflection appears clearly in the plane mirror because
1	most of the light waves are reflected on its soft surface
2	most of the light waves penetrate to its soft surface
3	most of the light waves are absorbed on its soft surface
Question No. (18)	Refracted light is
1	deviating from its course
2	continuing in the same course
3	going in the opposite direction of its course

Question No. (19)	One of the following colours is not included within the spectral colours:
1	red
2	green
3	brown
Question No. (20)	The colour that has the longest wave length is
1	red
2	green
3	indigo

<http://www.ejmste.com>



Audit Knowledge and Accounting Conservatism: A Case of Executives' Vocational Learning and Application

Bin Li

School of Economics and Management, Beijing University of Chemical Technology, Chaoyang District, Beijing 100029, P.R. China

Muze Peng

School of Economics and Management, Beijing University of Chemical Technology, Chaoyang District, Beijing 100029, P.R. China

Yingkui Zhang

School of Economics and Management, Beijing University of Chemical Technology, Chaoyang District, Beijing 100029, P.R. China

Received 8 June 2017 • Revised 26 July 2017 • Accepted 27 July 2017

ABSTRACT

This study examines the relation of audit knowledge and accounting conservatism based on the case of executives' vocational learning and application. The empirical results reveal the evidence of a negative relation between executives' audit knowledge and accounting conservatism. Further analysis indicates that the impact of executives' audit knowledge on accounting conservatism is only robust in companies without CEO duality. The results imply that companies with executives who have audit knowledge may adopt aggressive accounting policy and reduce the accounting conservatism of financial reports.

Keywords: audit knowledge, accounting conservatism, CEO duality

INTRODUCTION

Accounting conservatism means the asymmetry of recognizing loss and return in financial reporting (Basu, 1997). Accounting conservatism is not only an important index of accounting information quality (Ball et al. 2000), but also a kind of effective corporate governance mechanism (Ball et al. 2000; Watts, 2003). Audit knowledge is a kind of special professional knowledge. It is possible that companies' executives who get audit knowledge in former practical work will adopt different accounting policy and consequently lead to different accounting conservatism. Thus, we examine the relation of audit knowledge and accounting conservatism based on the case of executives' vocational learning and application.

Many previous studies focus on the impact of executives' characteristics like gender, background and shareholding on accounting conservatism (Ahmed and Duellman, 2007; Francis et al. 2015). Top managers will make choices and act based on their characteristics, thus giving rise to the phenomena that the organization is a reflection of its top managers (Hambrick and Mason, 1984). Therefore, negligence of executives' knowledge characteristics when researching in accounting conservatism will lead to the loss of validity and accuracy.

Managers with audit knowledge usually have sufficient accounting and auditing competence and professional experience that can make up investors' deficiency of knowledge in specific areas and promote the company management level. Especially, some of these executives once worked in the audit firms that their

© **Authors.** Terms and conditions of Creative Commons Attribution 4.0 International (CC BY 4.0) apply.

Correspondence: Yingkui Zhang, School of Economics and Management, Beijing University of Chemical Technology No. 15 Bei-san-huan Dong-lu, Chaoyang District, Beijing 100029, P.R. China.

✉ zhangyk@mail.buct.edu.cn

State of the literature

- Previous studies have not explored the impact of executives' audit knowledge on accounting conservatism from the perspective of knowledge management.
- The learning process does not stop with formal university education, and employees in the audit firms can get knowledge through vocational learning.
- Companies' executives who have audit knowledge may adopt different accounting policy and consequently lead to different accounting conservatism.

Contribution of this paper to the literature

- This study inspects the impact of executives' audit knowledge on accounting conservatism based on the case of executives' vocational learning and application.
- This study reveals the evidence of a negative relation between executives' audit knowledge and accounting conservatism and extends the research about the impact of executives' knowledge characteristic.
- This study indicates that the impact of executives' audit knowledge on accounting conservatism is only robust in companies without CEO duality and further enriches relevant documents about company governance.

companies cooperate with now. Their industry relationship network can effectively help the companies cope with external supervision. Therefore, more and more companies tend to employ executives with audit knowledge.

The existing literature mainly focuses on the impact of executives with audit firm connections on companies, a special case of executives' audit knowledge. Lennox (2005) researches the correlation between audit firm connections and audit quality and finds that companies with audit firm connections have a smaller probability of receiving non-standard audit opinions. Dowdell and Krishnan (2004) find companies with audit firm connections have higher level of accrual earnings management, which supports relevant clauses of SOX Act. However, there is also some research not finding significant impact of audit firm connections on accrual earnings (Geiger et al. 2005; Geiger and North, 2006). Geiger et al. (2008) even find that former auditor is holding the post of executive, not only has no effect on accounting information quality, but also has positive market reaction about the declaration day. Naiker and Sharma (2009) find employing a former auditor onto the board of auditors can enhance internal controls and financial reporting supervision.

We can conclude that previous studies have not reached a consensus on the impact of executives' audit knowledge on companies. Moreover, few studies pay attention to the correlation between executives' audit knowledge and company accounting conservatism. Especially, although executives' vocational learning and application has some distinct characteristics of knowledge management, previous studies have not explore the impact of executives' audit knowledge on accounting conservatism from the perspective of knowledge management.

Therefore, based on the case of executives' vocational learning and application, this study explores whether the financial reporting is less conservative when companies employ executives with audit knowledge, and examines whether the correlation will vary when the chairmen of the board are also the Chief Executive Officers (CEOs) in many companies, which is called CEO duality.

LITERATURE REVIEW AND HYPOTHESES

Executives' Audit Knowledge and Accounting Conservatism

In the era of information explosion, everyone faces various information. However, information is not equivalent to knowledge. Knowledge comes from the value-added process of organizing, analyzing and integrating information (Nonaka, 1994; Nonaka and Takeuchi, 1995). Knowledge management is also defined as the continuous

process of providing the right knowledge at the right time to members who need it to help them take the right action and consequently improve the organizational performance (Wang, 2013; Wu et al., 2016; Li et al., 2017).

The learning process does not stop with formal university education (Chen, Jones, and Moreland, 2014). People can get knowledge from many channels including workplaces. Employees' knowledge can be enhanced through professional practice and communication with each other. In the context vocational learning setting, Hannes et al. (2013) propose to stimulate communication, boundary crossing and knowledge sharing and establish an enabling learning environment that triggers positive factors for team learning.

In the accounting (audit) firms, managers decide upon the appropriate way to train promising individuals for the next level (Chen, Jones, and Moreland, 2014). KPMG, one of the biggest four audit firms in the world, implement an innovative workplace learning culture to reduce communication barriers within the chain of command, between employees and top management, and to encourage employees to construct group identity and transform themselves (Phornprapha, 2015). Employees' competence is a result of collaborative learning (Rózewski et al., 2015). Once completing the process of vocational learning in auditing work, the employees in audit firms can put the knowledge into application skillfully in the future.

From the company owners' point of view, their desires to achieve more profit are sometimes in conflict with the restrictive supervision from outside. Then the demand for executives with audit knowledge arises as a result. Executives with audit knowledge have sufficient accounting and auditing competence and better understanding of the company accounting system. They can arrange accounting operations that fit the company (Dowdell and Krishnan, 2004) and have the ability to obtain more benefits for investors without violating accounting standards. This may cause accounting conservatism to fall. Meanwhile, executives with audit knowledge usually have rich auditing experience and better acknowledge of common auditing processes and methods. They can cope with auditors easily. This may result in executives' over-confidence in their work and underestimate the impact of negative events on cash flow or overestimate future return from the current projects. Ahmed and Duellman (2013) found that executives' overconfidence has negative relationship with company accounting conservatism.

From the managers' point of view, they exercise management rights as the agent of company owners. The company owners usually use accounting reports as a standard to evaluate managers' performance. As a result, managers' remuneration is usually, directly or indirectly corresponding with financial reporting. Based on the assumption of rational economic people, executives always have the intention to maximize their own interest. Thus, executives with audit knowledge may take more aggressive accounting policy or choose opportunistic reporting practices. Both of them will lower the company accounting conservatism.

In addition, it is possible that executives with audit knowledge also have audit firm connections. Except for professional audit ability, these executives are familiar with common audit plans and methods that audit firms use and can easily bypass it (Dowdell and Krishnan, 2004; Lennox, 2005). In addition, compared with other countries' legal principles, in Chinese bureaucracy, administrators' decisions are under great influence of "relationship" (Hsiung, 2013). The companies with audit firm connections have more intense motivation to adopt aggressive accounting policy and to intervene in financial reporting. In such cases, generally speaking, auditors will increase audit procedures to guarantee audit quality and reduce audit risk. However, with presence of audit firm connections, external auditors may be too friendly to question their former colleague's judgment and cause audit quality to descend (Dowdell and Krishnan, 2004; Lennox, 2005). Overall, the first hypothesis is described as follows:

H1: Compared with other companies, the companies that employ executives with audit knowledge have lower accounting conservatism.

CEO Duality and Accounting Conservatism

The agency relationship between managers and shareholders arises from the separation of ownership and control rights of companies, that is, when the identity of managers is distinct from that of shareholders (Jensen and

Table 1. Sampling procedure

Sampling Procedure	Number
All observations from 2007 to 2014	17828
Less observations of B share companies	(859)
Less observations in financial industries	(333)
Less observations of ST companies*	(1010)
Less observations with missing data to compute accounting conservatism	(1223)
Less observations with missing data of executive characteristics	(472)
Number of observations in the final sample	13931

* ST is the abbreviation of Special Treatment, which means a listed company has abnormal financial position or other abnormalities.

Meckling, 1976). Managers have direct power to choose accounting policy and stockholders achieve the goal of indirectly manipulating accounting policy by exerting influence on them (Watts and Zimmerman, 1990). In general, the agency relationship between managers and shareholders is beneficial to improving the operation efficiency in modern companies.

However, with the separation of ownership and control rights, managers have incentives to transfer wealth to themselves from shareholders (LaFond and Roychowdhury, 2008). Imposing restrictions on executives' opportunistic actions can limit the ability of executives to overestimate earnings and net assets and lower the degree of information asymmetry (LaFond and Watts, 2008). Conservative financial reporting could facilitate efficient contracting between managers and shareholders in the presence of agency problems (Ball, 2001; Watts, 2003).

CEO duality is a common phenomenon in China, which reduces the information asymmetry and consequent knowledge difference between managers and shareholders to a great degree. CEO duality can reconcile the conflict of interest between CEOs and shareholders, which is the main reason for agency conflicts. Thus, CEO duality can relieve the agency problem between owners and managers to some degree (Anderson and Reeb, 2003; Villalonga and Amit, 2006). In contrast, in the companies without CEO duality, due to the knowledge advantage, executives have more intention and chance to maneuver financial reporting for their own benefits, and consequently lead to a lower accounting conservatism.

All of the above leads to the second hypothesis:

H2: Compared with companies with CEO duality, executives' audit knowledge has more robust negative impact on accounting conservatism in the companies without CEO duality.

METHODOLOGY

Data Sources

All of the data come from the Chinese Stock Market and Accounting Research (CSMAR) database and the data of executives' audit knowledge are supplemented by manual work. CSMAR database provides public financial data or stock price and is widely used in research in China like the COMPUSTAT/CRSP of US (Lennox, Wu, and Zhang, 2016). For China, has gone through twice great accounting reforms separately in 2006 and 2014, we select the data from 2007 to 2014 to ensure the comparability of data to some degree. In addition, to maintain the consistency of accounting policy environment, the sample does not contain the data of Chinese listed companies before 2007 or after 2014. To decrease the data error and bias, we specially set two groups, one to select the data and another one to check the work. We process the data through SPSS20 and Stata12.0. **Table 1** outlines the sampling procedure.

The initial sample has 17828 company-year observations. The final sample includes 13,931 observations after excluding B share companies (859), financial services and insurance companies (333), special treatment (ST) companies (1010) and observations with missing information to compute accounting conservatism (1223) or confirm executives' characteristics (472).

Table 2. Accounting conservatism test

Variable	Coef.	t	P> t
D_{it}	-0.00140	-0.98	0.328
R_{it}	0.00275***	3.63	0.000
$D_{it} * R_{it}$	0.05231***	10.88	0.000
Year controls		Yes	
Industry controls		Yes	
N		13931	
F		56.13	
Adj R-squared		0.0417	

In the table 2, R_{it} is the annual buy and hold return in year t and its positive or negative sign represent “good news” or “bad news”. D_{it} is an indicator variable set equal to 1 if R_{it} is negative, 0 otherwise. The coefficient of $D_{it} * R_{it}$ represents how loss recognition faster than return recognition. If the coefficient of $D_{it} * R_{it}$ is positive, we can conclude that the accounting policy in the company is conservative.

***, **, and * indicate significance at the 0.01, 0.05, and 0.10 level, respectively.

Accounting Conservatism Test

Basu (1997) makes a series of groundbreaking research on accounting conservatism. He uses positive stock return and negative stock return as measurements of “good news” and “bad news” and puts forward the asymmetric timeliness measure model (Basu, 1997). As a classic model in calculating accounting conservatism, Basu’s model provides thoughts and basis for latter scholars to examine accounting conservatism in many papers. Therefore, we firstly use Basu’s basic method to test accounting conservatism based on the final sample including 13931 company-year observations during the period of 2007 to 2014 in China. The results in **Table 2** significantly show that Chinese listed companies have financial reporting conservatism in this period.

Empirical Proxies and Variable Definitions

However, Dietrich et al. (2007), Givoly et al. (2007) and some other scholars question Basu’s asymmetric timeliness measure model for its validity. Therefore, in this study, we mainly use a negative accruals model brought out by Givoly and Hayn (2000) to examine accounting conservatism.

Based on the assumption that usually accruals and operating cash flows have negative relationship, Givoly and Hayn (2000) propose that persistent negative accruals can be used to measure accounting conservatism. That is because, in the long term, normal companies adopt unbiased accounting policy, and their cumulative net profit before depreciation and amortization should be in accordance with the net cash flow from operating activities. Namely, accruals should trend to be zero. However, because accounting conservatism means the asymmetry of recognizing loss and return, the accruals of a company would constantly be negative. Therefore, persistent negative accruals mean accounting earnings are steady in the company. The more negative cumulative accruals are, the stronger company accounting conservatism is.

Ryan (2006) considers negative accrual model as the most natural method to measure accounting conservatism. Many studies use this model to examine accounting conservatism (Ahmed and Duellman 2007; Zhang, 2008; Francis et al. 2015). The basic model is as follows:

$$CON_ACCRUAL = -TACCR_{it}/A_{it-1} = -(NI_{it} + DEPR_{it} - CFO_{it})/A_{it-1} \quad (1)$$

where $TACCR_{it}$ is total accruals in year t for company i , $TACCR_{it} = NI_{it} + DEPR_{it} - CFO_{it}$; NI_{it} is net margin in year t for company i ; $DEPR_{it}$ is depreciation cost in year t for company i ; CFO_{it} is operating cash flow in year t for company i ; A_{it-1} is total asset at the beginning of year t for company i .

To examine hypothesis H1, we build the following model based on negative accrual model:

Table 3. Variable definition

Variable	Description
Dependent Variable	
<i>CON_ACCRUAL</i>	The level of accounting conservatism every company-year.
Independent Variable	
<i>AWB</i>	A dummy variable, which equals to 1 if the executives in the company have audit knowledge, 0 otherwise.
Control Variables	
<i>Size</i>	The natural logarithm of total assets of the company.
<i>Lev</i>	The liability-asset ratio of the company.
<i>MTB</i>	The market-value to book-value of equity of the company.
<i>ROA</i>	The return on total asset of the company.
<i>OC</i>	The ownership concentration measured by Herfindahl-Hirschman Index 5 (the sum of squares of the percentage of share held by the top five shareholders)
<i>Own</i>	A dummy variable, which equals to 1 if the company is state-owned, 0 otherwise.
<i>CEOD</i>	A dummy variable, which equals to 1 if the company has CEO duality, 0 otherwise.
<i>CEOG</i>	A dummy variable, which equals to 1 if the CEO of the company is female, 0 otherwise.
<i>CEOE</i>	A variable, which equals to 1, 2, 3, 4, 5 if the CEO's education level is polytechnic school and below polytechnic school, junior college, bachelor degree, master degree and doctorate degree respectively.
<i>CEOF</i>	A dummy variable, which equals to 1 if the CEO has accounting experience, 0 otherwise.
<i>industry</i>	A variable that is controlled, which indicates the effect of industry
<i>year</i>	A variable that is controlled, which indicates the effect of year

$$\begin{aligned}
 CON_ACCRUAL = & \alpha_0 + \alpha_1 AWB + \alpha_2 Size + \alpha_3 Lev + \alpha_4 MTB + \alpha_5 ROA \\
 & + \alpha_6 OC + \alpha_7 Own + \alpha_8 CEOD + \alpha_9 CEOG + \alpha_{10} CEOE \\
 & + \alpha_{11} CEOF + year + industry + \varepsilon
 \end{aligned}
 \tag{2}$$

where, *CON_ACCRUAL* is the dependent variable to measure accounting conservatism every company-year. *AWB* is the independent variable, which is an indicator variable equal to 1 if the company has executives with audit knowledge, 0 otherwise. The executives defined in this study includes *CEO*, Chief Financial Officer (*CFO*), deputy general manager and the board secretary. We define executives with audit knowledge as executives who have audit work experience in audit firms.

We also control some important variables that maybe affect the results of regression in the former studies by Watts and Zimmerman (1978), Lennox (2005), Duellman (2006), Roychowdhury and Watts (2007) and other people, such as *Size*, *Lev*, *MTB*, *ROA*, *OC*, *Own* and *CEO* characteristics (*CEOD*, *CEOG*, *CEOE*, *CEOF*). Besides control variables mentioned in the model, we also control the effects of *industry* and *year* in regression. **Table 3** presents the definitions of variables.

To examine hypothesis H2, we divide the sample into two parts according to *CEO* duality (*CEOD*) and regress the model (2) in two subsamples: *CEOD* = 1 and *CEOD* = 0. Where *CEOD* is an indicator variable, which equals to 1 if there is *CEO* duality in the company, 0 otherwise.

Table 4. Regression results (whole sample)

Variable	Expected Sign	Coef.	t	P > t
<i>AWB</i>	-	-0.00722***	-2.65	0.008
<i>Size</i>	+	0.00225**	2.07	0.038
<i>LEV</i>	-	-0.04389***	-6.87	0.000
<i>MTB</i>	+	0.00009**	2.16	0.031
<i>ROA</i>	-	-0.24057***	-12.71	0.000
<i>OC</i>	-	-0.00374	-0.42	0.676
<i>Own</i>	-	-0.02482***	-10.29	0.000
<i>CEOD</i>	-	-0.01630***	-6.19	0.000
<i>CEOG</i>	-	-0.00622	-1.38	0.169
<i>CEOE</i>	+	0.00069	0.54	0.592
<i>CEOF</i>	+	0.01332***	2.95	0.003
<i>Year controls</i>			Yes	
<i>Industry controls</i>			Yes	
<i>N</i>			13931	
<i>F</i>			46.16	
<i>Adj R-squared</i>			0.0383	

***, **, and * indicate significance at the 0.01, 0.05, and 0.10 level, respectively.

We use the fixed effects model here. All control variables defined in table 3.

RESULTS

Whole Sample Regression Results

Table 4 presents the regression results of the whole sample by using the fixed effects model¹. According to the results shown in **Table 4**, we can find that the coefficient on *AWB* is negative and significant. Therefore, hypothesis H1 has been confirmed. This result indicates that companies employing executives with audit knowledge are apt to adopt aggressive accounting policy. The results in this study about executives' audit knowledge, including audit firm connections, are consistent with Dowdell and Krishnan (2004), Lennox (2005) and other scholars.

Subsample Regression Results

Table 5 presents the results for the relation between executives' audit knowledge and company accounting conservatism considering CEO duality. From the regression results in two subsamples, which are divided according to CEO duality, we can conclude that executives' audit knowledge has a robust negative impact on accounting conservatism only in companies without CEO duality. Moreover, in companies with CEO duality, the coefficient of the explanatory variable *AWB* is negative but not significant. Then hypothesis H2 has been confirmed. This result indicates that when a company lacks effective mechanisms to reduce the agency conflict, executives may use information and knowledge advantage to seek interest and boost the agency cost.

¹ The regression results show that the correlation coefficient between individual effects and explanatory variables isn't close to zero (0.0667) and result of F-test is significant (Prob > F = 0.000). Thus, we chose the fixed effects model here rather than random effects model or pooled OLS regression.

Table 5. Regression results (subsample)

Variable	Expected Sign	CEOD = 1			CEOD = 0		
		Coef.	t	P > t	Coef.	t	P > t
<i>AWB</i>	-	0.00219	0.35	0.726	-0.00864***	-2.95	0.003
<i>Size</i>	+	0.00030	0.10	0.923	0.00231**	2.10	0.036
<i>LEV</i>	-	-0.04486***	-2.68	0.007	-0.03713***	-5.65	0.000
<i>MTB</i>	+	0.00008	1.62	0.106	0.00004	0.40	0.686
<i>ROA</i>	-	-0.33075***	-6.73	0.000	-0.20433***	-10.39	0.000
<i>OC</i>	-	0.04502*	-1.83	0.068	0.00352	0.38	0.703
<i>Own</i>	-	-0.01813***	-2.65	0.008	-0.02829***	-11.61	0.000
<i>CEOG</i>	-	-0.01435	1.17	0.241	-0.00924**	-1.99	0.047
<i>CEOE</i>	+	0.00330	-1.10	0.273	0.00268*	1.94	0.053
<i>CEOF</i>	+	0.02119	1.64	0.101	0.01328*** 0.01355***	2.89	0.004
<i>Year controls</i>			Yes		Yes		
<i>Industry controls</i>			Yes		Yes		
<i>N</i>			3128		10803		
<i>F</i>			10.62		34.96		
<i>Adj R-squared</i>			0.0363		0.0345		

***, **, and * indicate significance at the 0.01, 0.05, and 0.10 level, respectively.

We use the fixed effects model here. All control variables defined in table 3.

Robustness Test Results

The existence of heteroscedasticity is also our major concern in the application of regression analysis, as it can invalidate significance of statistical test results, which usually assume the modeling errors are uncorrelated and uniform. Therefore, we apply a weighted least squares (WLS) estimation method to check the significance of explanatory variables. The **Table 6** presents the regression results of whole sample and the **Table 7** presents the regression results of subsample without CEO duality.

DISCUSSION

Empirical Findings

Executives' audit knowledge has a negative impact on company accounting conservatism. This can be explained as executives with audit knowledge implementing more aggressive accounting policy and lowering accounting conservatism by taking advantage of their special knowledge which includes professional experience and industry connection network.

Compared with other companies, in the companies without CEO duality where the information asymmetry and consequent knowledge difference between managers and shareholders is more serious, executives' audit knowledge has a more negative effect on accounting conservatism. This means the stockholders of these companies lack efficient ability to supervise the executives, which will give executives opportunities to manipulate the choice of accounting policy and financial reporting.

Table 6. WLS regression results (whole sample)

Variable	Expected Sign	Coef.	z	P> z
<i>AWB</i>	-	-0.00524***	-2.68	0.007
<i>Size</i>	+	0.00216	1.25	0.213
<i>LEV</i>	-	-0.04563***	-4.53	0.000
<i>MTB</i>	+	0.00009***	3.09	0.002
<i>ROA</i>	-	-0.23817***	-9.92	0.000
<i>OC</i>	-	-0.00171	-0.12	0.907
<i>Own</i>	-	-0.02521***	-5.57	0.000
<i>CEOD</i>	-	-0.01584***	-3.21	0.001
<i>CEOG</i>	-	-0.00634	-1.54	0.123
<i>CEOE</i>	+	-0.00008	-0.07	0.943
<i>CEOF</i>	+	0.01434**	2.33	0.020
<i>Year controls</i>			Yes	
<i>Industry controls</i>			Yes	
<i>N</i>			13931	
<i>Adj R-squared</i>			0.0335	

***, **, and * indicate significance at the 0.01, 0.05, and 0.10 level, respectively.

Table 7. WLS regression results (subsample)

Variable	Expected Sign	Coef.	z	P> z
<i>AWB</i>	-	-0.00688***	-5.00	0.000
<i>Size</i>	+	0.00187	1.59	0.111
<i>LEV</i>	-	-0.04297***	-5.21	0.000
<i>MTB</i>	+	0.00004	0.14	0.889
<i>ROA</i>	-	-0.20618***	-7.79	0.000
<i>OC</i>	-	0.00508	0.38	0.704
<i>Own</i>	-	-0.02649***	-5.99	0.000
<i>CEOG</i>	-	-0.00979	-1.60	0.111
<i>CEOE</i>	+	0.00191	1.33	0.185
<i>CEOF</i>	+	0.01376**	1.98	0.048
<i>Year controls</i>			Yes	
<i>Industry controls</i>			Yes	
<i>N</i>			10803	
<i>Adj R-squared</i>			0.0315	

***, **, and * indicate significance at the 0.01, 0.05, and 0.10 level, respectively.

Major Contributions

This study mainly contributes to the literature in two ways. Firstly, by inspecting the impact of executives' audit knowledge on accounting conservatism based on the case of executives' vocational learning and application, the study extends the research about the impact of executives' knowledge characteristic. Secondly, by considering CEO duality in China's listed companies, the study examines the variation of impact in the companies without CEO duality and further enriches relevant documents about company governance.

Potential Limitations

This study is subject to several certain limitations. First, although the empirical results are sound in the sample period from 2007 to 2014, we cannot claim that it is also robust before 2007 or after 2014. Second, because the study is completed based on Chinese data, the results may not generalize to other countries with different accounting policies and social conventions. Third, although the results are robust in robustness tests, we cannot say with certainty that model misspecifications or omitted variables have no influence on the conservatism measures.

CONCLUSION

Based on the case of executives' vocational learning and application, the empirical results reveal the evidence of a negative relation between executives' audit knowledge and accounting conservatism. Further analysis indicates that the impact of executives' audit knowledge on accounting conservatism is only robust in companies without CEO duality. Therefore, the companies with executives who have audit knowledge may adopt aggressive accounting policy and reduce the accounting conservatism.

This study provides evidence for supervision authorities to pay close attention to the risk of companies employing executives with audit knowledge and improve supervision system. It also implies that stockholders should intensify the supervision within the company on executives, especially on executives with audit knowledge.

ACKNOWLEDGEMENTS

This work was supported by the National Natural Science Foundation of China (Grant No. 71572008), the Social Science Foundation of Beijing (Grant No. 15JGC145), the Fundamental Research Funds for the Central Universities (Grant No. BUCTRC201512) and the State Scholarship Fund (CSC No. 201606885042).

REFERENCES

- Ahmed, A. S., & Duellman, S. (2007). Accounting conservatism and board of director's characteristics: an empirical analysis. *Journal of Accounting and Economics*, 43(2), 411-437.
- Ahmed, A. S., & Duellman, S. (2013). Managerial overconfidence and accounting conservatism. *Journal of Accounting Research*, 51(1), 1-30.
- Anderson, R. C., & Reeb, D. M. (2003). Founding—family ownership and firm performance: evidence from the S & P 500. *Journal of Finance*, 58(3), 1301-1328.
- Ball, R., Kothari, S. P., & Robin, A. (2000). The effect of international institutional factors on properties on accounting earnings. *Journal of Accounting and Economics*, 29(1), 1-51.
- Ball, R. (2001). Infrastructure requirements for an economically efficient system of public financial reporting and disclosure. *Brookings-Wharton Papers on Financial Services*, 127-169.
- Basu, S. (1997). The conservatism principle and the asymmetric timeliness of earnings. *Journal of Accounting and Economics*, 24(1), 3-37.
- Chen, C. C., Jones, K. T., & Moreland, K. (2014). Differences in Learning Styles. *CPA Journal*, 84(8), 46-51.
- Dietrich, J. R., Muller, K. A., & Riedl, E. J. (2007). Asymmetric timeliness tests of accounting conservatism. *Review of Accounting Studies*, 12(1), 95-124.
- Dowdell, T. D., & Krishnan, J. (2004). Former audit firm personnel as CFOs: Effect on earnings management. *Canadian Accounting Perspectives*, 3(1), 117-142.
- Duellman, S. (2006). *Evidence on the role of accounting conservatism and corporate governance*. North Dakota: North Dakota State University.
- Francis, B. B., Hasan, I., Park, J. C., & Wu, Q. (2015). Gender differences in financial reporting decision making: evidence from accounting conservatism. *Contemporary Accounting Research*, 32(3), 1285-1318.
- Geiger, M. A., North, D. S., & O'Connell, B. T. (2005). The auditor-to-client revolving door and earnings management. *Journal of Accounting, Auditing and Finance*, 20(1), 1-26.

- Geiger, M. A., & North, D. S. (2006). Does hiring a new CFO change things—an investigation of changes in discretionary accruals. *The Accounting Review*, 81(4), 781-809.
- Geiger, M. A., Lennox, C., & North, D. S. (2008). The hiring of accounting and finance officers from audit firms: how did the market react? *Review of Accounting Studies*, 13(1), 55-86.
- Givoly, D., & Hayn, C. (2000). The changing time-series properties of earnings, cash flows and accruals: Has financial reporting become more conservative? *Journal of Accounting and Economics*, 29(3), 287-320.
- Givoly, D., Hayn, C. K., & Natarajan, A. (2007). Measuring reporting conservatism. *The Accounting Review*, 82(1), 65-106.
- Hambrick, D. C., & Mason, P. A. (1984). Upper echelons: The organization as a reflection of its top managers. *Academy of Management Review*, 9(2), 193-206.
- Hannes, K., Raes, E., Vangenechten, K., Heyvaert, M., & Dochy, F. (2013). Experiences from employees with team learning in a vocational learning or work setting: A systematic review of qualitative evidence. *Educational Research Review*, 10, 116-132.
- Hsiung, B. (2013). Guanxi: personal connections in Chinese society. *Journal of Bioeconomics*, 15(1), 17-24.
- Jensen, M. C., & Meckling, W. H. (1976). Theory of the firm: managerial behavior, agency costs and ownership structure. *Journal of Financial Economics*, 3(4), 305-360.
- LaFond, R., & Watts, R. L. (2008). The information role of conservatism. *The Accounting Review*, 83(2), 447-478.
- LaFond, R., & Roychowdhury, S. (2008). Managerial ownership and accounting conservatism. *Journal of Accounting Research*, 46(1), 101-135.
- Lennox, C. (2005). Audit quality and executive officers' affiliations with CPA firms. *Journal of Accounting and Economics*, 39(2), 201-231.
- Lennox, C., Wu, X., & Zhang T. (2016). The effect of audit adjustments on earnings quality: evidence from China. *Journal of Accounting and Economics*, 61(2-3), 545-562.
- Li, B., Han, F., Liu, J. (2017). KM Theory Applied in Accounting and Statistics Education: Case on the Cost of Debt. *Eurasia Journal of Mathematics, Science and Technology Education*, 13(8), 4847-4856. doi:10.12973/eurasia.2017.00968a
- Naiker, V., & Sharma, D. S. (2009). Former audit partners on the audit committee and internal control deficiencies. *The Accounting Review*, 84(2), 559-587.
- Nonaka, I., & Takeuchi, H. (1995). *The knowledge-creating company*. New York: Oxford University Press.
- Nonaka, I. (1994). A dynamic theory of organizational knowledge creation. *Organization Science*, 5(1), 14-37.
- Phornprapha, S. (2015). People Passion programme: Implementing an innovative workplace learning culture through professional development—the case of KPMG Thailand. *International Review of Education*, 61(6), 795-814.
- Roychowdhury, S., & Watts, R. L. (2007). Asymmetric timeliness of earnings, market-to-book and conservatism in financial reporting. *Journal of Accounting and Economics*, 44(1), 2-31.
- Różewski, P., Jankowski, J., Bródka, P., & Michalski, R. (2015). Knowledge workers' collaborative learning behavior modeling in an organizational social network. *Computers in Human Behavior*, 51, 1248-1260.
- Ryan, S. G. (2006). Identifying conditional conservatism. *European Accounting Review*, 15(4), 511-525.
- Villalonga, B., & Amit, R. (2006). How do family ownership, control and management affect firm value? *Journal of Financial Economics*, 80(2), 385-417.
- Watts, R. L. (2003). Conservatism in accounting part I: explanation and implication. *Accounting Horizons*, 17(3), 207-221.
- Watts, R. L., & Zimmerman, J. L. (1978). Towards a positive theory of the determination of accounting standards. *The Accounting Review*, 53(1), 112-134.
- Watts, R. L., & Zimmerman, J. L. (1990). Positive accounting theory: A ten year perspective. *The Accounting Review*, 65(1), 131-156.

- Wang, T. S. (2013). Design and assessment of joyful mobile navigation systems based on TAM and integrating learning models applied on ecological teaching activity. *Eurasia Journal of Mathematics, Science and Technology Education*, 9(2), 191-200.
- Wu, Y. W., Lin, Y. A., Wen, M. H., Perng, Y. H., & Hsu, I. T. (2016). Design, analysis and user acceptance of architectural design education in learning system based on knowledge management theory. *Eurasia Journal of Mathematics, Science and Technology Education*, 12(11), 2835-2849.
- Zhang, J. (2008). The contracting benefits of accounting conservatism to lenders and borrowers. *Journal of Accounting and Economics*, 45(1), 27-54.

<http://www.ejmste.com>



Exploring In- and Pre-Service Science and Mathematics Teachers' Technology, Pedagogy, and Content Knowledge (TPACK): What Next?

Noha Alrwaished

Curriculum and Instructions, Kuwait University, KUWAIT

Ali Alkandari

Curriculum and Instructions, Kuwait University, KUWAIT

Fatimah Alhashem

Teacher Development Department, National Center for Education Development in Kuwait, KUWAIT

Received 27 February 2017 • Revised 5 May 2017 • Accepted 26 July 2017

ABSTRACT

The call to reform education systems is being heard in many countries around the world. The purpose of this study is to develop and apply a framework that captures some of the essential qualities of the knowledge required by teachers for effective pedagogical practice in a technology-enhanced educational environment using technology and pedagogy content knowledge (TPACK). A TPACK Short and Quick (TPACK-SQ) survey questionnaire was used to explore and assess 244 in- and pre-service science and mathematics teachers in Kuwait. The results of the survey showed that in-service teachers needed help with some aspects of TPACK. Therefore, a workshop was developed and 57 in-service teachers were enrolled and trained based on the TPACK-SQ model. The results of posttests for their knowledge were significantly positive as against pretests. The workshop thus provides a rich example of how to support the implementation of essential elements of the TPACK-SQ model.

Keywords: educational technology, integrated technology, professional development, technology pedagogical content knowledge (TPACK)

INTRODUCTION

The State of Kuwait, like many other countries, has been engaged in efforts to improve the national education system, spearheaded by the national Ministry of Education (MOE). The demand to reform the Kuwaiti education system has been spurred by various indicators. First, the National Ministry of Higher Education and Kuwait University have reported a high rate of student dropouts at the college level (Wiseman, Alromi, & Alshumrani, 2014). Second, Kuwait's results on international comparative assessments, such as the Trends in International Mathematics and Science Study (TIMSS) and Progress in International Reading Literacy Study (PIRLS), have been very low over the years (TIMSS, 2015). These results indicate that the education system needs reform to enhance better performance, especially in mathematics and science. Thus, the call for reforming education at both national and international level with focusing on core subjects: literature, math and science was essential demand. The term

© **Authors.** Terms and conditions of Creative Commons Attribution 4.0 International (CC BY 4.0) apply.

Correspondence: Fatimah Alhashem, *Teacher Development Department, National Center for Education Development in Kuwait, Kuwait.*

✉ falhashem80@gmail.com

State of the literature

- The findings can be used by science and mathematics head teachers, administrators, and curriculum developers to 1) better understand the nature of TPACK-SQ and its components and their implications for teacher professional development, 2) extend the knowledge of science and mathematics teachers' perceptions of TPACK-SQ, 3) enhance the knowledge of science and mathematics teachers' willingness to adopt TPACK-SQ in learning activities, and 4) based on the challenges identified, make suggestions regarding future research and applications of TPACK-SQ in science and mathematics education.

Contribution of this paper to the literature

- The results of this study should be helpful to science and mathematics head teachers, administrators, and curriculum developers to help them 1) clarify TPACK-SQ and specify its components in a meaningful framework for teacher preparation and professional development; 2) extend our knowledge of science and mathematics teachers' perceptions of TPACK, 3) enhance science and mathematics teachers' willingness to adopt TPACK-SQ and their ability to embody its framework in authentic learning activities during their instruction; and 4) based on the challenges they face, make suggestions regarding future research and applications of TPACK-SQ in science and mathematics education.

reforming is very comprehensive and it includes curriculum, teacher effectiveness, school systems, and the assessments.

While many scholars are interested in the reforming process that is taking place in the system of education, the current effort of this research is interested in teachers' development and their practices. More specific, we also found that the international trend is focusing on the integration of technology into common core curriculum and its related practices in learning and teaching content (National Research Council, 1996, Project 2061; American Association for the Advancement of Science, 1989, 1993; NCTM, 2000). Also, integration refers to integrating subjects together such as Science Technology Engineering and Mathematics (STEM) (Niess, & Gillow-Wiles, 2013). The integration requires capable teachers in the field who can adopt technology while practicing pedagogical skills to transform knowledge to students (Srisawasdi, 2012). Well recognized associations stressed on the concept of integration. The National Council of Teachers of Mathematics (NCTM) states, "Technology is essential in teaching and learning mathematics; it influences mathematics that is taught and enhances students' learning" (NCTM, 2000, p. 24). Also, "effective mathematics teaching requires understanding what students know and need to learn and then challenging and supporting them to learn it well" (NCTM, 2000, p. 16).

Therefore, the result of this study may help in providing a path to support both in-service and pre-service teachers. The focus will be clustered around professional development in the field of pre-service and in-service teachers with a clear vision and using a conceptual model. A Technology, Pedagogy, and Content Knowledge (TPACK) model is extensively used to scaffold teacher's integration knowledge and skills into their practices (Archambault & Crippen, 2009; Niess & Gillow-Wiles, 2013; Koh & Chai, 2014).

Based on the background above, this study explores current pedagogical, content, and technological knowledge with the goals of developing a sustainable program that assists, supports, and guides pre- and in-service teachers. In order to construct a learning program for teachers, we first adopt and justify the adoption of the TPACK conceptual framework of Mishra and Koehler (2006). Thereafter, within it, we focus on sustaining a professional development program from the pre-service stage to actual practice, with emphasis on science and mathematics subjects.

Thus, The main purposes of this study were to (a) explore and examine mathematics and science in-service and pre-service teachers' technology, pedagogy, and content knowledge (TPACK); (b) provide educators and stakeholders with the TPACK Short and Quick (TPACK-SQ) to be used as an assessment tool for teacher preparation programs TPACK related; (c) to provide suggestions and guidelines to enhance professional

development programs for teachers based on the results of TPACK-SQ. In this spirit, the research questions taken up are as follows:

1. To what extent can a TPACK-SQ self-report survey provide valid, reliable data about pre- and in-service teachers' TPACK?
2. To what extent do science and mathematics pre- and in-service teacher acquire TPACK?
3. Is there any significant difference between pre- and posttest in-service teachers' responses to the TPACK-SQ survey due to the workshop?

LITERATURE REVIEW

Kuwait Context

Various factors affect students' performance, including curriculum, school environment, assessment tools, and teachers. Effective teachers are facilitators of their students' learning, who deliver the objectives of their lessons while managing the classroom, assessing students, and providing them with the best guidance (Churchill, 2009). Nowadays, many universities and associations collaborate with education ministries and school districts to mount programs for sustaining novice teachers in their profession (Moonen, 2008; Ebrahim, 2012). In general, teachers need continuous professional development programming to maintain their pedagogical skills and need access to well-equipped classrooms with technology and tools (Ajlouni & Aljarrah, 2011; Archambault & Crippen, 2009). More specifically, this current study focused on teachers and how to scaffold their competence of integrating technology into their teaching and learning practices while teaching math or science as stated in both National Research Council, 1996), Project 2061 (American Association for the Advancement of Science, 1989, 1993); and NCTM, (2000).

In Kuwait, the (MOE) supports new and innovative programs to raise teachers' effectiveness, and asserts that using information and communication technology in teaching and learning at Kuwaiti schools will enhance education (MOE, 2014). The government of Kuwait has focused on education as an element for achieving economic development and social progress (Wiseman, Alromi, & Alshumrani, 2014). In 2014, Kuwait spent about 13% of its total budget on education. Education expenditure has increased from (USD) 3.6 billion in 2010 to (USD) 5 billion in 2011 (16%) of the total budget of the whole country (Wiseman, Alromi, & Alshumrani, 2014). However, the increase in spending for education is mainly for wages, salaries, and bonuses, which eat up three-quarters of this spending while less amount on professional development (Wiseman, Alromi, & Alshumrani, 2014).

As an example, in 2000, the MOE supported all in-service teachers to complete International Computer Driving License (ICDL) training courses for to gain ICT skills (Alayyar, 2011). It also provides limited training programs, but does not include the majority of teachers, which causes teachers to fall behind in updating themselves in their field (Alhashem, Al-jafar, 2015). The MOE provides three types of training for teachers: two-week training courses for beginner teachers, two-week training courses for promoted head departments, and a training course for development related to curriculum, evaluations, and assessment (NIE, 2013). This limited scope for engaging in state-provided training for teaching skills leads teachers to find other methods of training, such as seeking private training centers or courses and paying out of pocket (Alhashem, Al-jafar, 2015, 2015). Further, the school setting does not help teachers to adopt technology. For example, the lack of Internet connections in schools causes teachers to use their own wireless Internet devices, which is unaffordable for some of them. Schools have internet access, but it is generally limited to computer labs and offices. Equipping classrooms with technology but no access to internet may cause a lack of integration of technology and teaching (Alayyar, 2011).

The College of Education at Kuwait University has adopted a new and novel paradigm to prepare pre-service teachers. First, pre-service teachers take introduction to technology courses, followed by educational technology courses. Students at the college of education learn and practice basic skills that they should use in their lesson plans and in classroom management. Also, students are required to present an e-portfolio in their final year that contains a collection of their work during their studies at college such as projects and lesson plans (College of

Education Kuwait, 2015). The College of Education also provides its students with support to use technology in their program: its Information Technology Center coordinates with the Teaching Practicum Center to help students undergoing field training to reach their objectives, and introduces students to the latest developments in the field of learning technologies (TPCM, 2015). The university also provides varied technological services through the Distance and E-Learning Center, as well as more than 4,000 free e-training courses in information technology, business skills, and desktop courses (Al-Ansari, 2006).

The acronym TPACK refers to “technology and pedagogy content knowledge,” and these three elements (technology, pedagogy, and content) are presumed to be familiar to teachers and to be continually applied in their classrooms. Not only are teachers required to understand relevant content knowledge, they also need to know how to convey this content to their students; at the same time, they need to adapt and update their technological knowledge to keep up with technical and lifestyle developments. Therefore, it is essential that teachers understand the concept of TPACK, which will help them connect their skills with content via technological means to produce integrated lesson plans. More broadly, it is very important that teachers know how to add technology into their practice and to use different methods to deliver content. To instill such skills, a redesign of both preparation programs at colleges of education and professional development for pre-service and in-service teachers will be needed, based on the TPACK model. Thomas, Herring, Redmond, & Smaldino, (2013) stated that educational leaders must establish a clear vision for how their programs will develop candidates who are TPACK competent and who can become models/change agents at their schools.

Technology Integration in Education

The concept of integrating in education is a complex task due to its dynamic nature, especially when it comes to the involvement of technology. Integration in education is beneficial, “Research indicates that using an interdisciplinary or integrated curriculum provides opportunities for more relevant, less fragmented, and more stimulating experiences for learners” (Furner & Kumar, 2007; p.186). Many teachers have lack or gaps in their own subject content knowledge (Stinson, Harkness, Meyer & Stallworth, 2009) and asking math and science teachers to teach using technology may create new knowledge gaps and challenges (Stinson et al., 2009).

A main factor for improving and developing the education deals with integration in education. Previous studies, showed that integrating technology in education is challenging, complex and required strategic planning by the policy and decision makers (Hashim, 2007; Ghavifekr & Sufean, 2010). Moreover, Moonen (2008), stated that it is not difficult to have policies for IT (Information Technology) integration accepted for core technologies than for complementary technologies, which leaves technology isolated from integration while teaching other subjects.

Richardson (2009) designed a development project for in-service mathematics teachers to develop and explore TPACK in teaching and learning Algebra 1. They tried to transform content by integrating technology and pedagogical knowledge. After sixty hours of summer sessions and sixty hours of academic sessions, the researcher noticed the need to provide teachers with a special program to develop the integration of the technology, content, and pedagogy knowledge, allowing the teachers to clearly understand the benefit of teaching with technology.

In sum, students depend on their teacher's knowledge and practices. To provide best education, teachers must deeply understand math or science content; recognize the instructions and methods that need to be applied in the classroom according to the difference in students' abilities; utilize the best technology tools and embed them while teaching. While teachers need to know relevant content knowledge, they also need to know how to convey this content to their students; at the same time, they need to adapt and update their technological knowledge to keep up with technical and lifestyle developments. Therefore, it is essential that teachers understand the concept of TPACK, which will help them connect their skills with the content via technological means to produce integrated lesson plans. More broadly, it is very important that teachers know how to add technology into their practice and to use different methods to deliver content. To instill such skills a redesign of both preparation programs at colleges of education and professional development for pre-service and in-service teachers will be needed, based on the TPACK model.

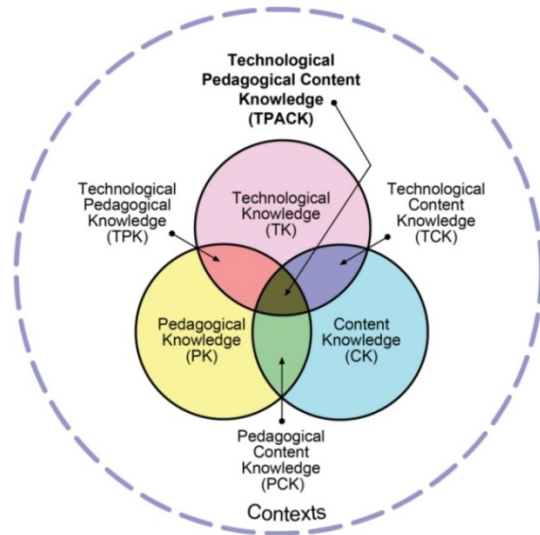

Figure 1. The components of the TPACK framework (Mishra & Koehler, 2006)

CONCEPTUAL FRAMEWORK

Mishra and Koehler (2006) introduced TPACK, which is an expansion of Shulman's pedagogical content knowledge theory. They built their model to effectively integrate technology into classroom practice in the context of advancements in its affordances as an educational tool.

The TPACK framework (Mishra & Koehler, 2006) breaks target knowledge down into three kinds: content, pedagogical, and technology. Intertwining these three produces four important domains: pedagogy content knowledge (PCK), technology content knowledge (TCK), technology pedagogy knowledge (TPK), and technology, pedagogy, and content knowledge (TPACK). Definitions of the knowledge constructs of the TPACK model, based on Mishra and Koehler (2006), follow:

- **Knowledge constructs** are the basic professional knowledge teachers must have in order to be prepared to teach. This includes up-to-date knowledge of their subject or specialization (NCED, 2014).
- **Technology knowledge (TK)** in the TPACK framework is similar to Fluency of Information Technology (NRC, 2012).
- **Content knowledge (CK)** is teachers' knowledge about the subject matter to be taught.
- **Pedagogical knowledge (PK)** is teachers' deep knowledge about the processes and practices or methods of teaching and learning, encompassing, among other factors, overall educational purposes, values, and aims.
- **Pedagogical content knowledge (PCK)**, knowledge of pedagogy that is applicable to teaching specific content.
- **Technological content knowledge (TCK)** is an understanding of the manner in which technology and content influence and constrain one another.
- **Technological pedagogical knowledge (TPK)** is an understanding of how teaching and learning can change when particular technologies are used in particular ways.

The main goal of TPACK is to demonstrate how teaching and learning using technological tools can change and improve students' understanding of any subject (Koehler, Mishra, & Yahya, 2007).

The TPACK model has informed the structure of many professional development programs for teachers (Jason, 2011). Many education systems have adopted TPACK as a framework for professional development and a guide for their progress towards 21st century teaching (Thompson & Mishra, 2008).

Many researchers have adopted TPACK as the framework for professional development as a guide for their progress towards 21st century learning (Thompson & Mishra, 2008; Archambault & Barnett, 2010; Thomas, et al 2013; Koh & Chai, 2014). They have adopted the TPACK model of Schmidt, Koehler, Mishra & Shin, (2009); the original survey consisted of 58 items and measured 124 pre-K to grade 6 pre-service teachers. TPACK instrument showed internal consistency of reliability ranged from .75 to .92 for the seven domains. Participants were prepared with common core curriculum content knowledge to reflect, mathematics, science, social studies, and literacy. Schmidt, et al. (2009) results suggested that 18 items of survey can be modified and still be reliable as an instrument to help educators design longitudinal studies to assess pre-service teachers' development of TPACK.

Koh & Chai, 2014 made slight adaptations to Schmidt et al.'s (2009) survey, mainly replacing the specific subjects (Math and Science) with the term curriculum study, to allow the Singaporean pre-service teachers to make reference to the teaching subjects they are trained to teach. They explored the adapted survey factor structure using a large sample (N > 1000). The analyses yielded 5 factors instead of seven factors. The results indicated that further refinement of the instrument has to be out carried.

In another study, Archambault & Barnett (2010) examined the nature of (TPACK) through the use of a factor analysis using a survey with 24 items designed to measure each of domains described in TPACK framework, each domain consisted of 3-4 items in each domain. The first domain had 10 items load in domain (1), 11 items load in domain (2) and 3 items load in domain (3). They suggested that measuring each of these domains is complicated and interleaved, potentially due to the notion that they were not separate.

Tee and Lee (2011) investigated how an improved problem-based learning approach can help in-service teachers in different subject areas support TPACK application while teaching. They designed a special 14-week course on technology and teaching based on TPACK, and noticed that over the progression of the course, teachers became more efficient at utilizing TPACK in teaching. They also noted that teachers gained better understanding of the role of technology in teaching. Harris and Hofer (2011) investigated how TPACK can inform their instructional planning and how it can enhance knowledge. In addition, they sought to discover clues to the nature and development of participating teachers' TPACK-in-action as it was expressed in the teachers' planning processes. The results showed that a) the type of selections, usage of learning activities and technology applications became more conscious, strategic, and varied; (b) instructional planning became more student-centered; and (c) quality standards for technology integration were raised. Olofson, Swallow, and Neumann (2016) used TPACK as a tool to foster changes in the teaching process for teacher with prior knowledge TPACK model. Their findings pointed to the relevance of TPACK in analyzing teacher practice.

Niessand and Gillow-Wiles (2013), focused on advancing teachers' interdisciplinary math and science content knowledge while integrating appropriate digital technologies such as learning and teaching tools. They used a mixed-method and interpretive study to examine in-service teachers' (TPACK) within the context of (STEM). The results outlined methods for coursework, and redefined interdisciplinary concept for teachers including students' understanding, instructional strategies, and use of technology within the curriculum.

In a different study on math and science teachers, Jang and Tsai (2012) explored TPACK model to develop a valid questionnaire and was used in elementary school context. The developed questionnaire contained 30 items in the four new components: 1) CK, 5 items; 2) PCK in the Context (PCK, 9 items); 3) TK, 4 items; and 4) TPCK in the Context (TPCKC, 12 items). The results of Jang and Tsai (2012) showed that the Ministry of Education in Taiwan supported using technology in school settings (Jang & Tsai, 2012).

In regard to preservice teachers, Thomas et al (2013), set a direction for transforming teacher education programs. They said those faculties are likely best positioned to relate how the knowledge and skills inherent in TPACK will best fit in the courses and field experiences of their program, as well as to identify the knowledge and skills they, themselves, require to create these learning experiences for their students. Thus, setting expectations

for performance and monitoring progress is required on two levels to understand both how students and teachers are making progress toward the goals. They identified, 1) resources, ways, and the support needed for a professional development, 2) initiative might scaffold work at the college level; and 3) supports needed in-service, college-level, context-specific products or processes.

Koh and Chai (2014) employed an instrument to categorize teachers into groups based on their self-reported TPACK before they were engaged in lesson design activities as part of their professional development. Based on the pre-course survey, the cluster analyses revealed two categories of pre-service and in-service teachers respectively. Pre-service teachers deepened the connections among TPK and TCK, and TPACK. In-service teachers who were more confident in their pre-course TPACK deepened the connections between CK and TPACK after ICT lesson design. In a similar case, Shinas, Yilmaz-Ozden, Mouza, Karchmer-Klein, and Glutting (2013) surveyed 365 pre-service teachers where they completed methods courses and field experience concurrent to the educational technology. The results showed that participants did not always make conceptual distinctions between the TPACK domains.

Archambault and Barnett, (2010) examined the validity of a TPACK survey that was employed in a 12-week ICT (Information communication technology) course designed for Singaporean primary school pre-service teachers. They were able to uncover five of the seven TPACK domains, which were a better model suitable as compared with several extant studies of TPACK surveys. They also found that PK had a direct impact on TPACK at the beginning of the course. As teachers made connections between their TC and PK to form TPK during the course, the direct relation between PK and TPACK became insignificant; whereas the relations between PK and TPK, and TPK and TPACK were strengthened. The comparison between the pre- and post-course models also revealed that the pre-service teachers' perceived relations between CK and TPACK changes from insignificant to significant.

Nevertheless, the challenge was laying in creating and validating an instrument that would be applicable in a multitude of contexts, including different content areas. "If this is not possible, then the conceptualization of TPACK may need to be different for every imaginable content area, including subject domains within each of these areas" (Archambault & Barnett, 2010, P 1660). One of the major opportunities has been given to the researchers in this current study was attempting to measure content knowledge, as knowledge of the subject matter to be taught (e.g. science, mathematics, language arts, etc.).

METHOD

The study is mainly quantitative, with a design, instruments, and settings created based on the conceptual framework. The 34 self-report items to reflect TPACK Schmidt, et al. (2009) were adopted and modified, based on results Archambault and Crippen (2009), and Koh & Chai (2014) and customized to the context of this research. So that participants rate the extent, to which they applied each of the item responses after the exposure to two, 3-credit courses "technology in education and "learning media & resources" planned for pre-service teachers; and a designed workshop (see Appendix 2) for in-service one.

Participants

As of 2014, there were 6,763 mathematics teachers and 6,638 science teachers in Kuwaiti schools (Kuwaiti Ministry of Education, 2014) and 236 pre-service teachers of mathematics and 530 of science (College of Education (Kuwait), 2015). The sample of this study consisted of 244 participants Table participants **Table 1** shows the participants' positions and specializations.

Table 1. Participants

	Pre-service	In-service	Total
Science	64	68	132
Mathematics	26	86	112
Total	90	154	244

Instruments

The instrument used was modified to reflect the theoretical framework of Schmidt et al. (2009). In that study, internal consistency reliability ranged from .75 to .92 for the seven TPACK subscales. The instrument showed with internal consistency reliability ranged from .75 to .92 for the seven TPACK subscales. In a similar study, Koh & Chai, 2014 made slight modifications to Schmidt et al.'s (2009) instrument in replacing core subjects (Mathematic, Science etc.) with the term curriculum study. The analyses yielded five factors instead of seven factors. Archambault & Barnett (2010) examined the nature of (TPACK) through the use of a factor analysis using a survey of 24 items, 10 items load in Factor (1), 11 items load in factor (2) and 3 items load in factor (3). Since TPACK presents an unmanageable number of test items, researchers reduced the number of items, as mentioned above, developing a fast, reliable, and teacher-related survey. The focus of the present study is science and mathematics education, we modified it to meet the context of this research.

TPACK Internal Structure

In order to assess the internal structure of TPACK when applied to different contexts (i.e. Kuwait), we applied Exploratory Factor Analysis (EFA) procedures to the 34-item survey. Prior to analyses, standard data screening procedures did not identify any univariate outliers. Sample size requirements were met ($n=244$ and within acceptable range). In addition, all 34 items bivariate correlations were at least 0.3 suggesting reasonable factorability. Secondly, the Kaiser-Meyer-Olkin measure of sampling adequacy was .93, above the commonly recommended value of .6, and Bartlett's test of sphericity was significant ($\chi^2(561) = 8383.37.26, p < .05$). Moreover, all communalities were above 0.6. Given these overall indicators, factor analysis was suitable with all 34 items. EFA results showed that five factors could be retained with Eigenvalues >1 , with first five factors explaining 50%, 9.4%, and 4%, 3.5%, 3.2% of the variance respectively. The five-factor solution, which explained 70.9% of the variance, was retained using Kaiser rule. Items-Factor loading ranges for each factor (from 0.4 to 0.85). Three Complex items, which was relying on more than one factor, were seen (TK7, PCK5, and TPK1). CK2, Items were modified based on the results in the instrument which was led by the results of EFA. (see, appendix 1). Overall, these analyses indicated that five distinct factors were underlying participant's responses to the TPACK-SQ items and that these factors were moderately internally consistent. The instrument was reviewed and approved by educational technology and educational psychology scholars for content validity. The final instrument – TPACK-SQ – consists of 34 items for exploration of in- and pre-service teachers' TPACK.

Validity

The content validity of TPACK-SQ was assessed and statistically significant correlations among its subscales explored using Pearson correlation coefficients. These correlations were statically significant, meaning that the knowledge of technology, pedagogy, content, and their intersections are related. See [Table 2](#).

Reliability

Reliability statistics were conducted on the seven TPACK-SQ subscales within each knowledge domain. The internal consistency reliability (coefficient alpha) ranged from .817 to .882 for the seven TPACK-SQ subscales. According to George and Mallery (2001), this range is considered acceptable to excellent.

The final version of TPACK-SQ was tested for reliability through a test-retest method; 20 pre-service teachers and 30 in-service teachers took the final survey (in Arabic), and then again after two weeks. For the pre-service teachers, reliability was 0.82 and for the in-service teachers it was 0.73, which is consistent with Schmidt et al. (2009).

Procedures

As part of this research plan, we collected data on in-service and pre-service mathematics and science teachers' self-assessment of their knowledge of the seven knowledge components within the TPACK framework.

Table 2. Pearson Correlation Coefficients Between TPACK-SQ Subscales

		TK	CK	PK	PCK	TCK	TPK	TPACK
TK	Pearson correlation	1	.19**	.21**	.13*	.40**	.42**	.35**
	Sig. (2-tailed)		.00	.00	.03	.00	.00	.00
CK	Pearson correlation	.19**	1	.59**	.52**	.46**	.45**	.50**
	Sig. (2-tailed)	.00		.00	.00	.00	.00	.00
PK	Pearson correlation	.21**	.59**	1	.60**	.48**	.54**	.52**
	Sig. (2-tailed)	.00	.00		.00	.00	.00	.00
PCK	Pearson correlation	.13*	.52**	.60**	1	.56**	.58**	.51**
	Sig. (2-tailed)	.03	.00	.00		.00	.00	.00
TCK	Pearson correlation	.40**	.46**	.48**	.56**	1	.80**	.72**
	Sig. (2-tailed)	.00	.00	.00	.00		.00	.00
TPK	Pearson correlation	.42**	.45**	.54**	.58**	.80**	1	.75**
	Sig. (2-tailed)	.00	.00	.00	.00	.00		.00
TPACK	Pearson correlation	.35**	.50**	.52**	.51**	.72**	.75**	1
	Sig. (2-tailed)	.000	.00	.00	.00	.00	.00	

** . Correlation is significant at the $p < .05$, ** $p < .01$ level (2-tailed)

Table 3. Developed TPACK Workshops

Day	Activity	Lecturers
Day one	Introduction to TPACK-SQ; adapting technology into teaching in science and mathematics; explaining the study	The researchers
Day two	Workshop modeling technology in teaching	Technology professor
Day three	Workshop on pedagogical skills for teaching science or mathematics	Curriculum professors
Day four	Assigning groups; matching the TPACK-SQ model with science and math lessons	The researchers
Day five	Working day—groups work on lesson plans based on TPACK-SQ model.	Mathematics and science supervisors/ professors
Day six	Presentation/assessment and evaluation of participants' work	The researchers

The modified instrument was then field-tested among Kuwaiti pre-service and in-service teachers and revised based on information gathered from this pilot.

The first phase of the study was conducted with both pre-service and in-service teachers in order to explore the effectiveness of the TPACK-SQ model. In regard of time duration of the survey, we calculated eight groups of 20 to 57 participants' time responses, and the time was ranged from 4:50 to 5:00 minutes.

In-service teachers who scored low on the first phase were invited to participate in the second phase of the study. Only 57 teachers participated, on a voluntary basis, responding to the TPACK-SQ survey anonymously. Then, they completed a workshop about TPACK-SQ (**Table 3**).

The workshop was designed to explain the intersection of the seven components of TPACK to participants, with a particular focus on the overlap of TCK, PCK, and TPK. The main goal was to train participants on how to

Table 4. T-Test Results for Pre-Service and In-Service Teachers' Means for TPACK-SQ Subscales

Subscale	Position	M	SD	t	p
TK	Pre-service	3.89	0.72	.772	.442
	In-service	3.77	0.65		
CK	Pre-service	4.38	0.63	5.412	.000
	In-service	3.80	0.40		
PK	Pre-service	4.16	0.49	3.192	.002
	In-service	3.88	0.33		
PCK	Pre-service	4.21	0.51	5.340	.000
	In-service	3.71	0.38		
TCK	Pre-service	4.11	0.77	2.206	.030
	In-service	3.85	0.38		
TPK	Pre-service	4.17	0.68	4.301	.000
	In-service	3.67	0.43		
TPACK	Pre-service	4.17	0.60	4.732	.000
	In-service	3.66	0.42		

transform mathematics and science topics from a traditional style of instruction to one that utilizes and integrates TPACK. The most important steps in the workshop are listed below:

- Introduction of TPACK.
- Explaining the effects on students of teaching methods and students' abilities and skills.
- Introduction to the role of technological tools in lesson planning.
- Each group chose a topic and designed a lesson based on the TPACK model.

RESULTS

The current study used a quantitative research method. The Cronbach's alpha was calculated for each subscale of the TPACK-SQ survey to ensure the reliability of each result. Respondents' (that is, pre- and in-service teachers') descriptive data were reported for each subscale; and Pearson correlation analysis was undertaken to explore how the subscales are related to each component.

In addition, in- and pre-service mean scores and standard deviations were calculated to evaluate participants knowledge of how to adopt pedagogical strategies to foster learners' understanding of the subject matter (PCK), evaluate knowledge of novel and specific technologies to teach or facilitate instruction (TCK), probe their knowledge of how the technology can be used in teaching the subject (PTK), and assess their understanding as it emerges from interactions among content, pedagogy, and technology knowledge (TPACK).

Next, a series of *t*-tests were used to explore the responses on each factor of the TPACK-SQ survey.

An independent-samples *t*-test was conducted to explore differences and similarities in responses between pre-service and in-service teachers (see **Table 4**). There was a significant difference between the scores for pre-service ($M=4.17$, $SD=0.60$) and in-service ($M=3.66$, $SD=0.42$) teachers ($t=4.732$, $p=0.00$), with in-service teachers scoring quite low. In any case, there appear to be knowledge gaps between university and workplace. Being successful in the former institution does not guarantee success in the latter (Zeichner, 2010).

An independent-samples *t*-test was conducted to compare pre-service teachers' results in math with those in science. All subscales and the overall TPACK-SQ did not show significant differences between science pre-service teachers ($M=3.87$, $SD=0.57$) and mathematics pre-service teachers ($M=3.79$, $SD=0.49$); $t=0.597$, $p=0.552$. These results suggest that both science and mathematics pre-service teachers are experiencing more or less the same type of learning and training for teaching, and that in both cases TPACK-SQ can be used as a assessment tool survey to

Table 5. T-Test Results for Pre-Service Specialization-Based Means for TPACK-SQ Subscales

Subscale	Specialization	N	M	SD	t	p
TK	Science	64	3.84	0.64	.481	.632
	Mathematics	26	3.76	0.76		
CK	Science	64	4.01	0.50	.153	.879
	Mathematics	26	4.03	0.73		
PK	Science	64	3.99	0.43	.281	.779
	Mathematics	26	3.96	0.39		
PCK	Science	64	3.89	0.53	.215	.830
	Mathematics	26	3.91	0.41		
TCK	Science	64	3.99	0.50	1.156	.251
	Mathematics	26	3.84	0.70		
TPK	Science	64	3.87	0.56	.447	.656
	Mathematics	26	3.81	0.65		
TPACK	Science	64	3.87	0.57	.597	.552
	Mathematics	26	3.79	0.49		

Table 6. T-Test Results for In-Service Specialization-Based Means for TPACK-SQ Subscales

Subscale	Specialization	M	SD	t	p
TK	Science	3.96	0.65	1.950	0.05
	Mathematics	3.71	0.76		
CK	Science	4.07	0.60	2.178	0.03
	Mathematics	3.75	0.28		
PK	Science	4.01	0.43	1.930	0.054
	Mathematics	3.79	0.27		
PCK	Science	3.93	0.51	1.560	0.12
	Mathematics	3.73	0.38		
TCK	Science	4.09	0.58	2.21	0.035
	Mathematics	3.64	0.43		
TPK	Science	3.95	0.60	1.907	0.05
	Mathematics	3.60	0.45		
TPACK	Science	3.93	0.56	2.965	0.01
	Mathematics	3.51	0.35		

(re)design and (re)structure their education. This result aligns with the observation of Jang and Chen (2010) that TPACK model could help pre-service teachers develop technological pedagogical methods and strategies for integrating subject-matter knowledge into lessons, further enhancing their TPACK-SQ results.

An independent-samples t-test (**Table 6**) was conducted to compare the responses of in-service teachers in science to those in mathematics. Science teachers were found to do significantly better than mathematics teachers in TPACK, TCK, and TPK, while there was no significant difference in PCK.

Table 7 shows the mean score differences between pretest (before the workshop) and posttest (after it).

On the basis of the above results, an independent-samples t-test was conducted to compare pretest and posttest results for the 57 in-service teachers. The results indicated significant differences in TK, TCK, and TPACK. The TK subscale for posttest was significant ($M=3.82$, $SD=0.67$), as were pretest results ($M=3.51$, $SD=0.70$) ($t=3.389$, $p=0.001$). The TCK subscale showed a significant difference from the posttest ($M=3.95$, $SD=0.56$) and pretest results ($M=3.78$, $SD=0.58$) ($t=2.156$, $p=0.032$). The TPACK model t-test showed a significant difference from posttest ($M=3.85$, $SD=0.55$) ($t=2.095$, $p=0.037$). These results suggest that the workshop for in-service teachers had an encouraging impact on the TPACK model and could be helpful in integrating technology and pedagogy skills while

Table 7. T-Test Results for Pre- and Posttest Means for TPACK-SQ Subscales

Subscale	Group	M	SD	t	p
TK	Pretest	3.51	0.70	3.389	.001
	Posttest	3.82	0.67		
CK	Pretest	3.88	0.60	1.685	.093
	Posttest	4.01	0.57		
PK	Pretest	4.02	0.54	.529	.597
	Posttest	3.98	0.42		
PCK	Pretest	3.95	0.58	.732	.465
	Posttest	3.89	0.49		
TCK	Pretest	3.78	0.58	2.156	.032
	Posttest	3.95	0.56		
TPK	Pretest	3.77	0.61	.968	.334
	Posttest	3.85	0.58		
TPACK	Pretest	3.68	0.60	2.095	.037
	Posttest	3.85	0.55		

teaching science and mathematics. Even more, the results allow us to articulate specific considerations for school-based professional development (re)design to help do a better job preparing science and mathematics teachers for their careers and the workplace.

DISCUSSION

This study adopted the 34 self-report TPACK items (Schmidt, et al. 2009) with modifications reported by Archambault and Crippen (2009) and Koh & Chai (2014) while being customized to the context of this research. Participants rated the extent to which they applied each item after the exposure to two 3-credit courses “technology in education and “learning media & resources” planned for pre-service teachers; and a workshop for in-service one.

The TPACK- SQ survey showed a valid and a reliable data about pre- and post-teachers’ knowledge. The study focused on helping teachers learn about TPACK-SQ and implement it, investigating both pre-service and in-service teachers in both science and mathematics. It was shown that the streamlined survey employed here can be used as an assessment tool to identify the training needed. The survey items duration time came to average of 4:30 to 5:00 minutes. Thus, the results of TPACK-SQ can guide the development and implementation of programs to prepare future teachers for a K-12 science/mathematics classroom environment in which technology significantly impacts and changes teaching and learning; aligned with Thomas et, al (2013) notions of setting institutional direction for TPACK. This approach also allows us to articulate principles for the redesign of university education to do a better job in preparing science and mathematics pre-service teachers for their future workplaces.

Within the review of the literature, TPACK has been conceptualized as a seven-factor construct to describe teacher’s integration of T in their teaching and their students’ learning. However, this framework has yet to be successfully validated through survey instruments (Archambault & Barnett, 2010; Ozgun-Koca, Meagher, & Edwards, 2010); Shinas, et, al, 2013; Koh & Chai, 2014).

Referring to the extension of how much teachers acquire, results showed that pre-service teachers appeared to be more confident in integrating technology than in service ones. Pre-service teachers were capable in their instructional and pedagogical practices, which may reflect the valid use of technology in learning environment of college of education. This confirms the existence of a technological gap between higher education institutions and workplace, due to the availability and accessibility of technology (COE, 2015; Alqahtani & Al-Enezi, 2012).

No significant difference was found among pre-service teachers in terms of specialization (science or mathematics). In contrast, in-service science teachers did significantly better than in-service mathematics teachers

on TPACK, TCK, and TPK, which confirmed Jang, & Tsai (2012) results. This could be due to more technology exposure, or greater availability of science materials, devices, and tools in school's laboratory learning environment. The results supported previous studies showed that teacher in service lack of using the technology while teaching (Koh, & Chai, 2014). Liang, Chair, Koh, Yang, and Tsai (2013) showed that senior teachers might show a certain degree of resistance toward technology integrated teaching environment. Inopportunately, when it comes to technology application, the focus clustered around providing hardware and equipping the place with less attention on software and programs (Moonen, 2008). Moreover, most of efforts have been put into utilizing instead of integration technologies. (Ozgun-Koca, et al., 2010); Koh, & Chai, 2014).

The results of the survey showed that pre-service teachers had more opportunities to practice TPACK than in-service ones. Pre-service teachers tended to use eLearning resources on campus more than in-service teachers at school due to the school culture and settings, which caused a limitation due to shortages in wireless access. The results reflected back on providing the support through the Teaching Practicum Center at the college of education for pre-service teachers with support needed during their training (Alqahtani & AlEnezi, 2012). The advantage of having access to internet on camps for pre-service teachers helped in integrating technology while practicing teaching science or mathematics, which may have had an effect on the results of the survey.

In the results, there was no significant difference in terms of the specialization (science or mathematics) at the college of education. These results may indicate that both mathematics and science pre-service teachers are being trained and experience the same type of teaching the same way. These results positively echo the recommendations of National Science Education Standards (NSES), (NRC, 1996); mathematics education (NCTM, 2000); STEM, (Niess, & Gillow-Wiles, 2013) of integration of technology into common core curriculum and its related practices in learning and teaching content Project 2061, (1989); NCTM, (2000) or the integration of subjects such as STEM.

Moreover, the workshop provided opportunities for 57 in-service teachers to participate and make meaningful contributions throughout the design process. Elements of the workshop supported teachers' efforts to implement the TPACK-SQ, especially in science and mathematics. Moreover, the professional development afforded by TPACK-SQ provided a rich example of how to support the implementation of some of essential elements of the TPACK model. The results of the workshop were thus meaningful for in-service teachers in both science and math.

Professional training and development refers to many types of educational experiences to learn and apply new knowledge and skills that will improve teacher performance on the job related to the individual's work (Thompson & Mishra, 2008; Archambault & Barnett, 2010)). No doubt, training and professional development programs for teachers would allow them to have opportunities to learn more from time to time. Moreover, such programs will ensure teachers stay up-to-date on education information in certain research areas and the latest curriculum implemented and that teachers are engaging with new technology available and several resources that help to improve their teaching. The training provided by central office will provide a platform for teachers to upgrade their skills and knowledge, sharing knowledge with peers, and connecting to the latest changes in the education field (Niess, & Gillow-Wiles, 2013; Koh & Chai (2014).

CONCLUSION

This study comes out with a valid and reliable instrument to reflect TPACK domains. In addition, TPACK conceptual framework has been put into practices, and reveal an intertwine domains, which is required be adapt to content, pedagogy and technology knowledge to meet updated knowledge and technology essential for 21st century requirements.

Bridging Technological gap between the colleges and the school settings is important. This requires the involvement of policy makers and stakeholders to identify the needs; such as better schools settings, comprehensive professional development program for elevating the qualities of teaching, and learning to overcome 21st challenges.

The present study applied Technology, Pedagogy, and Content Knowledge Short and Quick (TPACK-SQ), a notion built on an integrated framework determined by the theoretical principles of the TPACK model found by Schmidt et al. (2009). This framework was developed and implemented among pre- and in-service teachers in the attempt to validate and sustain TPACK-SQ overall and its components collectively (TPK, TCK and PCK).

The investigation showed that TPACK-SQ can be used effectively to further in-school professional development of science and mathematics teachers in relation to the integration of educational technology in their practice. This includes classrooms, schools, and virtual learning environments.

The presentation of the general outcome of TPACK-SQ is followed by a report on the impact of workshop participants' representations of TPACK-SQ components and their views of and ability to integrate technology in science and mathematics practice. TPACK-SQ is reliable with respect to exploratory factor analysis in a new setting, or contexts.

Finally, in light of the challenges that emerged in relation to the use of this framework, we make suggestions regarding future research and applications of TPACK-SQ in science and mathematics teacher preparation.

The findings can be used by science and mathematics head teachers, administrators, and curriculum developers to 1) better understand the nature of TPACK-SQ and its components and their implications for teacher professional development, 2) extend the knowledge of science and mathematics teachers' perceptions of TPACK-SQ, 3) enhance the knowledge of science and mathematics teachers' willingness to adopt TPACK-SQ in learning activities, and 4) based on the challenges identified, make suggestions regarding future research and applications of TPACK-SQ in science and mathematics education. Finally, in light of the challenges that emerged in relation to the use of this framework, we make suggestions regarding future research and applications of TPACK-SQ in science and mathematics teacher preparation.

In addition, the in-service teachers may have no choice other than shifting to the traditional method because of the school context (Alhashem, & Alkandri, 2015). Teaching science or mathematics with a traditional method due to the lack of resources at schools and few or no professional development courses may have affected the in-service teachers results. The findings showed a gap between the college and field settings. In-service teachers' lack of professional development during their service at school may also have an effect on teachers' abilities to reflect back on their knowledge (Alhashem, & Alkandri, 2015).

Implications for Further Studies

Our final thought for this study is that TPACK-SQ can be used as reliable and valid assessment tool survey. We hope that curriculum developers, professional development leaders, and teachers will take advantage of the TPACK-SQ model to integrate its domains into the teaching of science and mathematics. We recommend that stakeholders mount TPACK-SQ model workshops, not only for math and science teachers but also in other subjects.

More research is needed to expand the TPACK model as a form of professional development or curriculum implementation. The presentation of the general outcome of TPACK-SQ is followed by a report on the impact of workshop participants' representations of TPACK-SQ components and their views of and ability to integrate technology in science and mathematics practice.

REFERENCES

- Ajlouni, K., & Aljarrah, A. (2011). The impact of using the KidSmart program on facilitating children's access and use of ICT tools according to Jordanian public kindergarten teachers' viewpoint. *Education*, 132(2), 241-261.
- Al-Ansari, H. (2006). Internet use by the faculty members of Kuwait University. *The Electronic Library*, 24(6), 791-803.

- Alayyar, G. M. (2011). *Developing pre-service teacher competencies for ICT integration through design teams*. Unpublished doctoral dissertation, University of Twente.
- Alhashem, F., & Al-jafar, A. (2015). Assessing teacher's integration of technology and literacy in elementary science classrooms in Kuwait. *Asian Social Science*, 11(18), 71-81.
- Alhashem, F., & Alkandri, A. (2015). What did Kuwait Learn from its participation in TIMSS study? An exploratory case study from senior supervisors' perspectives. *Asian Social Science*, 11(27), 298-310.
- Alkandari, A. (2013). The effect of e-activities on student achievement and motivation toward learning. *The Educational Journal*, 109(1), 13-50.
- Alkandari, A., & Al Helal, A. (2012). The relative effectiveness of microcomputer-based laboratory real-time graphing on seventh grade students' graph interpretation ability. *Educational Journal, Kuwait University*, 87(4), 20-45.
- Alqahtani, A., & Al-Enezi, M. (2012). Mastering leadership concepts through utilizing critical thinking strategies within educational administration courses at Kuwait University. *College Student Journal*, 46(3), 508-525.
- American Association for the Advancement of Science. (1989). *Science for all Americans*. New York: Oxford University Press.
- American Association for the Advancement of Science. (1993). *Benchmarks for science literacy*. New York: Oxford University Press.
- Archambault, L. M., & Barnett, J. H. (2010). Revisiting technological pedagogical content knowledge: Exploring the TPACK framework. *Computers & Education*, 55(4), 1656-1662.
- Archambault, L., & Crippen, K. (2009). Examining TPACK among K-12 online distance educators in the United States. *Contemporary Issues in Technology and Teacher Education*, 9(1), 71-88.
- Chai, C. S., Koh, J. H. L., Tsai, C. C., & Tan, L. L. W. (2011). Modeling primary school pre-service teachers' technological pedagogical content knowledge (TPACK) for meaningful learning with information and communication technology (ICT). *Computers & Education*, 57(1), 1184-1193.
- Churchill, D. (2009). Educational applications of Web 2.0: Using blogs to support teaching and learning. *British Journal of Educational Technology*, 40(1), 179-183.
- College of Education (Kuwait). (2015). *Teaching Practicum Center Manual*. Kuwait City: Kuwait University Press.
- Ebrahim, A. (2012). The self-efficacy of pre-service elementary teachers in Kuwaiti science programs. *Education*, 133(1), 67-76.
- Furner, J., & Kumar, D. (2007). The mathematics and science integration argument: a stand for teacher education. *Eurasia Journal of Mathematics, Science & Technology*, 3(3), 185-189.
- George, D., & Mallery, P. (2001). *SPSS for windows step by step: A simple guide and reference 10.0 update* (3rd ed.). Needham Heights, MA: Allyn & Bacon.
- Ghavifekr, S., & Sufean, H. (2010). Management as visionary planning for dealing with systemic change: A case of Malaysian Open Distance Learning Institution. *International Journal of Sustainable Development*, 1(4), 79-85.
- Harris, J. B., & Hofer, M. J. (2011). Technological pedagogical content knowledge (TPACK) in action: A descriptive study of secondary teachers' curriculum-based, technology-related instructional planning. *Journal of Research on Technology in Education*, 43(3), 211-229.
- Hashim, Y. (2007). Value literacy as conduit for managing change in higher education institutions. In Sufean Hussin et al. (Eds.), *The whirlwind in educational management and policy*. Kuala Lumpur: UM Publication.
- International Association for the Evaluation of Educational Achievement (November 2015). *TIMSS 2015 and TIMSS Advanced 2015 international results*. Retrieved from <http://timss2015.org/#/?playlistId=0&videoId=0>
- Jang, S. J., & Chen, K. C. (2010). From PCK to TPACK: Developing a assessment tool model for pre-service science teachers. *Journal of Science Education and Technology*, 19(6), 553-564.
- Jang, S. J., & Tsai, M. F. (2012). Exploring the TPACK of Taiwanese Elementary Mathematics and Science Teachers with Respect to Use of Interactive Whiteboards. *Computers & Education*, 59(2), 327-338.
- Jason, T. A. (2011). An investigation of the relationship between self-efficacy beliefs about technology integration and technological pedagogical content knowledge (TPACK) among pre-service teachers. *Journal of Digital Learning in Teacher Education*, 27(4), 134-143.

- Jordan, C. (2011). Beginning teacher knowledge: Results from a self-assessed TPACK survey. *Australian Educational Computing, 26*(1), 16–26.
- Koehler, M. J., Mishra, P., & Yahya, K. (2007). Tracing the development of teacher knowledge in a design seminar: Integrating content, pedagogy and technology. *Computers & Education, 49*(3), 740–762.
- Koh, J. H. L., Chai, C. S., & Tsai, C. C. (2014). Demographic Factors, TPACK Constructs, and Teachers' Perceptions of Constructivist-Oriented TPACK. *Educational Technology & Society, 17*(1), 185–196.
- Liang, J., Chair, C., Koh, J., Yang, C., & Tsai, C. (2013). Surveying in-service preschool teachers' technological pedagogical content knowledge. *Australasian Journal of Educational Technology, 29*(4), 581–594.
- Ministry of Education (Kuwait). (2014). *Ministry of Education statistics workers*. Publication No. 28. Kuwait City: Ministry of Education.
- Mishra, P., & Koehler, M. (2006). Technological pedagogical content knowledge: A framework for integrating technology in teacher knowledge. *Teachers College Record, 108*(6), 1017–1054.
- Moonen, J. (2008). Evolution of IT and related educational policies in international organizations. In J. Voogt & G. Knezek (Eds.), *International handbook of information technology in primary and secondary education*. New York: Springer.
- National Centre for Education Development (2014). *Teacher Standard*. Ministry of Education. Kuwait. Prepared by the Education Standards Committee.
- National Conference for the Development of Education (Kuwait). (2008). *Proceedings from National ICT in Education Strategy*. Kuwait City: NCDE.
- National Council of Teachers of Mathematics (United States). (2000). *Principles and standards for school mathematics*. Reston, VA: NCTM.
- National Institute of Education (Kuwait). (2013, May 23). *International conducts a diagnostic study of Kuwait's education system*. Retrieved from <http://www.nced.com.kw>
- National Research Council (Kuwait). (2012). *A framework for K-12 science education: Practices, crosscutting concepts, and core ideas*. Washington, DC: The National Academies Press.
- National Research Council. (1994). NRC. 1996. *Nutrient requirements of beef cattle, 7*, 242.
- Niess, M. L., & Gillow-Wiles, H. (2013). Advancing K-8 teachers' STEM education for teaching interdisciplinary science and mathematics with technologies. *Journal of Computers in Mathematics & Science Teaching, 32*(2), 219–245.
- Olofson, M. W., Swallow, M. J., & Neumann, M. D. (2016). TPACKing: A constructivist framing of TPACK to analyze teachers' construction of knowledge. *Computers & Education, 95*, 188–201.
- Ozgun-Koca, S. A., Meagher, M., & Edwards, M. (2010). Preservice teachers' emerging TPACK in a technology-rich methods class. *The Mathematics Educator, 19*(2), 10–20.
- Richardson, S. (2009). Mathematics teachers' development, exploration, and advancement of technological pedagogical content knowledge in the teaching and learning of algebra. *Contemporary Issues in Technology and Teacher Education, 9*(2), 117–130.
- Schmidt, A. D., Baran, E., Thompson, A. D., Mishra, P., Koehler, M. J., & Shin, T. S. (2009). Technological pedagogical content knowledge (TPACK): The development and validation of an assessment instrument for preservice teachers. *Journal of Research on Technology in Education, 42*(2), 123–149.
- Shinas, V. H., Yilmaz-Ozden, S., Mouza, C., Karchmer-Klein, R., & Glutting, J. J. (2013). Examining domains of technological pedagogical content knowledge using factor analysis. *Journal of Research on Technology in Education, 45*(4), 339–360.
- Srisawasdi, N. (2012). Fostering pre-service STEM teachers' technological pedagogical content knowledge: A lesson learned from case-based learning approach. *Journal of The Korean Association for Science Education, 32*(8), 1356–1366.
- Stinson, K., Harkness, S., Meyer, H., & Stallworth, J. (2009). Mathematics and science integration: models and characterizations. *School Science and Mathematics, 109*(3), 153–161. doi: 10.1111/j.1949-8594.2009.tb17951.x
- Tee, M. Y., & Lee, S. S. (2011). From socialization to internalisation: Cultivating technological pedagogical content knowledge through problem-based learning. *Australasian Journal of Educational Technology, 27*(1), 89–104.

- Thomas, T., Herring, M., Redmond, P., & Smaldino, S. (2013). Leading change and innovation in teacher preparation: A blueprint for developing TPACK ready teacher candidates. *TechTrends*, 57(5), 55.
- Thompson, A., & Mishra, P. (2008). Breaking news: TPCK becomes TPACK!. *Journal of Computing in Teacher Education*, 24(2), 38-64.
- Wiseman, A. W., Alromi, N. H., & Alshumrani, S. (2014). Challenges to creating an Arabian Gulf knowledge economy. *Education for a Knowledge Society in Arabian Gulf Countries*, 24, 1-33.
- Zeichner, K. (2010). Rethinking the connections between campus courses and field experiences in college-and university-based teacher education. *Journal of Teacher Education*, 61(1-2), 89-99.

APPENDICES

APPENDIX 1

Appendix Table 1 Rotated component matrix

		1	2	3	4	5
1	TK1			.755		
2	TK2		.460	.693		
3	TK3			.781		
4	TK4			.704		
5	TK5			.751		
6	TK6			.721		.439
7	TK7		.401	.477	.551	
8	CK1	.487			.610	
9	CK2				.714	
10	CK3				.766	
11	PK1	.696	.356			
12	PK2	.774				
13	PK3	.740	.396			
14	PK4	.609	.426			
15	PK5	.706	.450			
16	PK6	.760				
17	PK7	.703				
18	PCK1	.713	.413			
19	PCK2	.696	.397			
20	PCK3	.659				
21	PCK4	.482		.490		
22	PCK5	.619	.435	.414		
23	PCK6	.576	.539			
24	PCK7	.529	.590			
25	TPK1	.478	.468	.421		
26	TPK2	.469	.537			
27	TPK3		.634	.411		
28	TPK4					.742
29	TPK5	.532	.564			
30	TPACK1		.684			.405
31	TPACK2	.396	.751			
32	TPACK3		.750			
33	TPACK4		.699			
34	TPACK5		.681			

APPENDIX 2

Appendix Table 2 TPACK Workshops for Pre-/In-Service Mathematics and Science Teachers in Kuwait

CK (Knowledge of subject area)	PK (How to teach)	TCK/TPK (How to integrate content and pedagogy with technology)	TPACK
The content was focused, limited to mathematics and science learning for middle and high school grades (6–12)	Developing lecturer pedagogical content knowledge through focused professional conversations	TPK: Blog, forums, discussion board, and various social media	An integrated interactive web discussion about science and mathematics topics
	Individualizing group assessment using an e-portfolio	TPK: Cloud-based assessment & reporting -Interdisciplinary evaluation of integration of e-portfolio as a learning and teaching (L&T) tool during professional experience placement	Evaluating science and mathematics work using advanced technological tools
	-Using technology while teaching -Interactive tools to improve students' understanding of environmental aspects of membrane-transport processes in plants	TCK: Digital media content	Utilize digital media while teaching science/mathematics
	-Theseus: A video game for teaching math -Development of experimental and learning environment	TPK: Editing/sharing videos (e.g., Jing, Animoto Photo-Realistic 3D Virtual Models) -Virtual visits: exploring the learning environment	Teaching mathematics/science through videos and 3D virtual models
	Computing & Information Systems Theseus: A video game for teaching philosophy	Maintaining a personal social-media site: Facebook, Myspace, wiki (e.g., Confluence)	Introduce teachers to how to facilitate it in teaching and learning
	YouTube earth science lesson	TPK/TCK: YouTube channels	Connecting teachers to YouTube channels
	Connecting with students, parents, and society -Cultural competence for life	TPK: Editing/sharing documents (e.g., Google online office, blog, interest group forum, digital storytelling) -Web-based course management software (e.g., Moodle, BlackBoard) for learning/content management -Engaging in community of practice (learning discourse approach)	Make teachers active in school society through technology and advanced pedagogical tools

<http://www.ejmste.com>



<http://www.ejmste.com>



<https://twitter.com/ejmste>



<https://www.facebook.com/ejmste>



<http://modestum.co.uk/>



publications@modestum.co.uk



OPEN ACCESS

EURASIA Journal of Mathematics Science and Technology Education
ISSN: 1305-8223 (online) 1305-8215 (print)
2017 13(9):6133-6145
DOI: 10.12973/eurasia.2017.01054a



The Study of Consumer Green Education via the Internet of Things with Green Marketing

Jui-Che Tu

Department of Graduate School of Design Doctoral Program, National Yunlin University of Science & Technology, Taiwan

Yu-Yin Chen

Department of Graduate School of Design Doctoral Program, National Yunlin University of Science & Technology, Taiwan

Shih-Chung Chen

Department of Electrical Engineering, Southern Taiwan University of Science & Technology, Tainan, Taiwan

Received 4 June 2017 • Revised 28 July 2017 • Accepted 15 August 2017

ABSTRACT

Environmental protection and green education are important global issues. The Internet of things (IoT) is a new effective communication medium for advertisement and dissemination. To promote the concepts of environment protection with green marketing via the IoT is the aim of the study. Case study and focus group are adopted for experiment and analysis. After qualitative analysis, we use factor analysis and regression analysis to analyze the statistical results of questionnaires. The effective questionnaires returned rate of this research is 282/300(94%). The analysis results of Likert scale show that Cronbach's α for 5 factors are all higher than 0.7 which means the reliability of this research is good. The result of regression analysis also shows that significance of green marketing via the IoT for consumers' green education is obviously effective. This research presents an indispensable and interesting education way to create a multi-win situation for businesses, consumers, governments and our earth.

Keywords: Internet of Things, green marketing, green education, interactive advertising, sustainable development

INTRODUCTION

Green development is a global focus issue. Since the industrial revolution, the global warming has led to change in the ecosystem (Alfredsson, E. C., 2004), the awareness of environment protection is no longer just a slogan, as one of global people we should take action immediately in daily life.

Consumers will choose green products and services gradually because of popular green education. Therefore, commercial companies will observe consumers' behavior to develop marketing strategies, green marketing will be accepted progressively in wide range of innovative markets (Chien, Yuju, 2011). What is IoT? According to the definition on the web site of Wikipedia, the Internet of things (IoT) is the inter-networking of physical devices, vehicles (also referred to as "connected devices" and "smart devices"), buildings, and other items embedded with electronics, software, sensors, actuators, and network connectivity which enable these objects to collect and exchange data (Elgar Fleisch, 2010). IoT is a new internet technology integrating software, hardware and firmware (Ian G Smith, 2012). The commercial companies with the concept of environment protection will

© **Authors.** Terms and conditions of Creative Commons Attribution 4.0 International (CC BY 4.0) apply.

Correspondence: Yu-Yin Chen, No.123, Sec. 3, University Road, Douliu City, Yunlin County 640, Taiwan (R.O.C.).

✉ supereater@hotmail.com

State of the literature

- First, the IoT is the current trend, and the green education is what people rarely concerned, this study combines the IoT with the green education.
- Secondly, to constitute a bridge between the IoT and green education by green marketing, and make an investigation with focus group interview.
- Finally, the results of the focus group interview suggest the hypotheses, then we adopted the mathematic methods to prove the hypotheses are reasonable.

Contribution of this paper to the literature

- As a result of focus groups interview, consumers are impressed by the green marketing activities via the IoT, which thereby affects the purchasing rate.
- The results of the mathematical analysis show that the education level of consumer will affect the consumer's attitude towards environmental protection.
- Regardless of gender, age, educational level and income, consumers will be guided by the concept of environmental education via the IoT interaction with green marketing, thereby to change consumers' values and choose the environment friendly goods.
- Therefore, this study provides a new win-win market model for business, environment and consumer.

develop green marketing with the help of IoT application to transfer green messages effectively and attractive more consumers (Luigi Atzori & Antonio Iera & Giacomo Morabito, 2010).

Attitude is the important factor of learning and experiencing. People's psychological reaction to the environment is so called environmental attitude. Green education will enhance people's green attitude. People's attitude always affect their behaviors. Therefore, green marketing is a key promotion activity in the implementation of environmental protection. How to utilize the IoT? IoT generally offer the automatic machine with a friendly interactive interface (Rolf H. Weber, 2010). Interactive interface is a bridge between human beings and machine. Enterprises always create new promotion policy and service methods to attract customers (Luigi Atzori & Antonio Iera & Giacomo Morabito, 2010). Green marketing is a new concept of promotion policy and IoT is a new service method. Integrating green marketing and IoT technology can make the costumers satisfied with green ways of shopping. Managers always consider to bring innovative concepts into the whole enterprise to develop new markets and fortunes (Fraj, E. & Martinez, E., 2006).

Green marketing impels green education, which means companies have to sell their products in a green way, so they can earn more profits and promote their brand value more effectively (Ottman, J. A., 1999). Moreover, the enterprise can carry out their social responsibility.

In the wake of highly developing economy and science, the object of advertisings have already been focusing on the consumers (Hui-Hsin Huang, 2015). Thus, consumers' behavior can not only lead the way to green trend but also reboot the market. Obviously, green marketing and consumers' green education play the important roles for the issue of environment protection. The IoT will be the effective dissemination medium or tool for green marketing and green education even commercial advertisements.

PURPOSE OF THE RESEARCH

What we do for the environment becomes the most important thing when the facts of global warming and climate changes become true. This research focuses on the effect of people's thoughts and behaviors regarding the issues of green marketing and consumer green education via the IoT.

The purpose of this research is to analyze whether the green marketing can affect consumers and lead to a good result of green education. The result of this study can offer governments and other enterprises a good reference to popularize the concept of environment protection and make a win-win situation.

LITERATURE REVIEW

The Internet of Things

Many Governments regard IoT as a very important innovative technology. Japan develops a management system combines green power and the IoT by separated electricity and smart power meters. This system can not only supply to residents and companies, but also exchange power to different areas (Hung, Wan-Chi, 2016).

The technology of artificial intelligence is added value to new generation of IoT. New IoT will be humanized. More and more employees and resources will be utilized on developing new IoT technology (Ian G Smith, 2012). However, the IoT is still based on the technologies of computer and internet, it's possible to be affected by various reasons, such as natural disasters or hackers, only if we have further consideration and safer design, then we can well prepare for the green application of new generation of IoT (Elgar Fleisch, 2010).

Green Education

Green education is the basic knowledge and persistent learning for the life of human and globe environment protection. It can teach people green concept and change their behaviors by education. Green education is also regarded as the sustainable environmental education (EE) that is the teaching of individuals, and communities, in transitioning to a society that is knowledgeable of the environment and its associated problems, aware of the solutions to these problems, and motivated to solve them. (https://en.wikipedia.org/wiki/Environmental_education & Larjani, M. & Yeshodhara, K., 2008).

It is very important to implant the concept of sustainable environmental protection into the people's minds via popular green education in daily life (David Lewis & Darren Bridger, 2001). We believe tomorrow will be better if everyone can be self-conscious and take the responsibility to execute the behavior of environmental protection.

Green Marketing

Green marketing is an ideal method that the enterprises can meet the requirements of making their benefits and implementing sustainable environmental protection at the same time. Green marketing tries to examine the relationship between consumers' socio-economic factors and their willingness to pay more for environmental friendly products, finding the percentages that consumers are agreed to pay for green marketing (Ottman, J. A., 1999). Green marketing creates an environment-friendly basis that enterprises can get the maximum profit and consumers can take responsibility for sustainable environmental protection.

According to the rules defined by WTO agreement, enterprises consider the "sustainable environmental development" as a potential competitive advantage source. Environmental attitudes have a significant effect on ecological behavior. (Fraj, E., & Martinez, E., 2006). From the operational point of view, it will be the trend of new business model to implement green behavior and enhance the efficiency and competitiveness of enterprises to content with the needs of consumers and building a better the future of the earth (Schiffman, L. G. & Kanuk, L. L., 2007).

On the whole, this study defines green marketing as a new marketing strategy that takes care of the benefits of enterprises, consumers and the environment in the meantime.

Interactive Advertising

Interactive advertising is one kind of conversations or dialog, not monolog. The effect of interactive advertising is changed and enhanced from one-way communication to two-way communication (Burton, S., & Lichtenstein, D. R., 1988). Enterprises have to invent the new languages and new style of speaking to impress their consumers. Interactive advertising has entered the era of consumer-dominated, from one way description to mutual communication with consumers (Mehta, A., 2000).

Table 1. Three subtopics of sustainable development

Fairness	Sustainability	Commonality
Social level	Economic level	Natural ecology level
Advocate equitable distribution and flatter people’s basic needs on contemporary and future generations.	Advocate sustainable economic growth of protecting the earth.	Advocate human beings and nature live in harmony.

The Involvement or participation of Consumer allows the interactive advertising model to be set up (Ying-Ru Yen, 2007). However, the participation of consumer combines with interactive advertising will result in the consequence of customization. The consumer is no longer just a bystander of advertising (Daft, R. L. & Lengel, R. H., 1986).

The IoT is closely related to digital media. It is also an effective technology to well implement interactive advertising because of the impact of internet. The use of Internet technology is free from time and space constraints, the enterprise can interactively communicate with consumers and raise consumer involvement with the help of IoT to deepen consumers’ impressions and increasing customers’ purchasing power.

Sustainable Development

WCED released a report in 1987 called “Our common future,” a definition of sustainable development is announced in the report as: “development that meets the needs of the present without compromising the ability of future generations to meet their own needs.” (Roseland, M., 2012). Sustainable development can be discussed as follows including three subtopics which are fairness, sustainability and commonality as shown in **Table 1**.

Sustainable environmental development is the basic rule of peace between human beings and nature. Human beings must do their best to maintain the sustainable environment while developing new technologies.

Case Study Method

Case study I: Recycling bottles to cash-Taiwan supermarket “Carrefour Taiwan”

Carrefour Taiwan which is an agent of Carrefour French, collaborates with local government of Hualien County in Taiwan to set up the automatic recycling services system for environmental protection resources. Consumers throw the recycled bottles into the automatic recycling machine to exchange shopping cash. Carrefour Taiwan designed the first Taiwan automatic recycling machine for environmental protection as shown in **Figure 1** which benefit not only consumers but also environmental protection and the reputation of Carrefour Taiwan.

Case study II: Antarctica Beer Turnstile

“Do not drive after drinking!” is a very popular slogan of beer. In most cases, these kinds of warnings of beer advertising are just regarded as slogans. Most of the brewers only require themselves to design the slogan in line with the legal norms, and no further step. However, Antarctica implements the slogan of advertising to let a beer can become as a MRT ticket as shown in **Figure 2**. On one hand, they convince people do not drive after drinking, on the other hand, the beer cans can be recycled at the same time. Antarctica fulfills the implementation of environmental protection behavior.



Figure 1. The first Taiwan automatic recycling machine for environmental protection (Poja,2016)

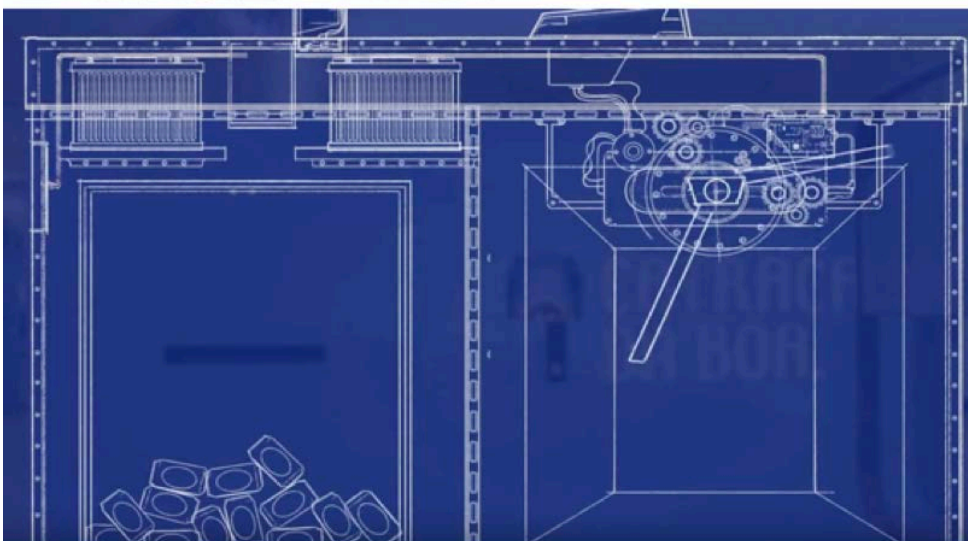

Figure 2. Antarctica Beer Turnstile (iThome, 2015)

Table 2. Members list of focus group interview

Code (Male: M; Female: F)	Age	Education level	Task
M01 (Teacher)	56	Ph.D. degree	Focus group member
M02 (Student)	22	Bachelor degree	Focus group member
F03 (Student)	18	High school	Focus group member
M04 (Freelance)	60	Junior high school	Focus group member
M05 (Freelance)	40	Master degree	Focus group member
F06 (Office worker)	35	Bachelor degree	Focus group member
F07 (Housewife)	38	High school	Focus group member
F08 (Boss)	29	Bachelor degree	Focus group member
M09 (Temporary worker)	21	Junior high school	Focus group member
F10 (Office worker)	25	Master degree	Focus group member
F11 (Student)	27	Ph.D. student	Host

Focus Group Method

The focus group method means a small group, but including demographically diverse people whose reactions are studied especially in market research or political analysis. This method guides or opens discussions via interview and questionnaire about a new product or something else to determine the reactions that can be expected to represent the subjects' thinking from a larger population (Stewart, D.W., & Shamdasani, P. N., 1990). During this study process, the researcher either takes notes or records the feedback of vital points from the members of the focus group. There are two study cases discussed in this paper, one is Carrefour Taiwan the other is Antarctica Beer.

DATA COLLECTION

This experiment of focus group interview invited 11 subjects as shown in [Table 2](#) to attend focus group interview, the ratio of male and female is half and half, the range of subjects' ages from 18 years old to 60 years old, the education levels are between junior high to Ph.D.

The Results of Focus Group Method

After focus group interview and the privacy survey of cross-comparison, we found that if the condition is the same price of products with green messages, then the subjects whose ages from 22 to 40, average income between \$30,000-99,999 NTD, education level above college or higher, would buy the products with green messages. In addition, if the condition is the same price of products with interactive advertising, the subjects whose age from 18 to 21 and over 40 years old, education level under college, average income between \$30,000-69,999 NTD, would change the purchasing behavior to choose the product with interactive advertising because of the interesting experience from the interactive advertising. However, if there is no green message or interactive advertising condition, they would still choose the brand they used to buy. In short, the systematic analysis of focus group shows that consumers are willing to pay the products which has interactive advertising with green message, regardless of age, education, and the average income level. Meanwhile, according to the investigation result of focus group method as shown in [Table 3](#), we can show that three factors of green marketing, the IoT and consumer interactive communication are necessary and complementary. If missing one of these three factors, it could not achieve the high degree of consumers' involvement and purchasing rate.

Table 3. The result of focus group interview

Research note	Results	
	High Purchase Intention	High Involvement
If the same price of products with different brands, would you like to choose the product with an interactive advertising?	M01, M02, F03, M04, MO5, F06, F07, F08, M09, F10	M01, M02, F03, M04, MO5, F06, F07, F08, M09, F10
Why do you choose an interactive advertising brand to buy?	M01, F02, M05, F06, F08, F10	M01, F02, M05, F06, F08, F10
If the same price of products with different brands, would you like to choose the product with green messages?	M01, M02, F03, MO5, F06, F08, F10	M01, M02, F03, M04, MO5, F06, F07, F08, M09, F10
What's your concern about environmental protection?	M01, MO5, F06, F07, F08, F10	M01, M02, F03, M04, MO5, F06, F07, F08, M09, F10
Do you have the impression of the enterprise which has the interactive advertising case?	M01, M02, F03, M04, MO5, F06, F07, F08, M09, F10	M01, M02, F03, M04, MO5, F06, F07, F08, M09, F10
Do you think that the product with green message is the better?	M01, M04, MO5, F06, F07, F08, F10	M01, M02, M04, MO5, F06, F07, F08, F10
There are two products, one has interactive advertising with green message the other just has interactive advertising, which product you want to buy?	M01, MO5, F06, F07, F08, F10	M01, MO5, F06, F07, F08, F10
If there is a product related with environmental protection and health, would you like to buy this kind of environment friendly goods?	M01, MO5, F06, F07, F08, F10	M01, MO5, F06, F07, F08, F10

HYPOTHESES

In the process of focus group method, this study adopted factor analysis and regression analysis to analyze the questionnaires about the recycling issue under the following assumptions:

H01: The higher degree of education, the higher degree of environmental protection concept.

H02: The advertising attitude has a positive impact on the consumer purchasing intention.

H03: The environmental attitude of consumer has a positive impact on the purchasing intention.

H04: Interactive advertising with green marketing via the IoT should have the positive effect of green education to consumers.

We disseminated the network and physical questionnaires in this research, each subject took about 20-25 minutes to fill in the questionnaire. The questionnaires regarding this research were disseminated from the date of 15th April 2017 to 15th May 2017. Total 300 copies were given to 300 subjects. 18 of 300 questionnaires are invalid, there are only 282 valid questionnaires returned, and the overall return ratio of questionnaire is 94%.

MATHEMATIC METHODOLOGY

This experiment of IoT with green marketing adopted the case of the beer company as the object of research. The first step, arranging the focus group interviews for the subjects with different age, different income and different education level. The second step, we defined four assumptions after finishing the opinion investigation of focus group interview. The third step, we adopted the mathematic methods, such as factor analysis

and regressive analysis, to analyze the consumers' attitude toward IoT with green marketing and the characteristics of consumers and finally prove that the four assumptions above are reasonable.

The design of questionnaire is based on the four key items of consumers' values, consumers' attitude for advertising, consumers' green attitude and consumers' purchasing intention. The definitions of the research variables are as follows:

The Value Relations of Consumer

The experiment mentioned above utilizes the structure of value relations (Schwartz, S. H., 1992) as a framework. Schwartz derived the following ten basic values: stimulation, self-direction, hedonism, achievement, power, security, conformity, tradition, benevolence, and universalism. Each basic value is described in terms of motivation and goal. A set of more specific value adjectives for expressing the basic value are given in parentheses after each basic value description.

300 subjects were invited to reply the questionnaires which give variable score of 1 to 5 (1: very unimportant, 2: unimportant, 3: no opinion, 4: important, 5: very important, meaning the degree of importance) to be chosen by each subject for each question according to the example of Likert scale.

Attitude toward Advertising

In this research, we used Likert scale to measure subjects' attitude toward advertising. The questionnaires asked the subjects that "This advertising reminds me not to drive after drinking", "This advertising delivers green concept", "This advertising impressed me", "This advertising makes me want to get the product" and "This advertising changes my habit". The Cronbach's α analysis result of questionnaires for investigating the subjects' attitude toward advertising is 0.903.

Attitude toward Green (Consumer Environmental Attitude)

We measured how much the subjects agree with the green concept by giving 1 to 5 points of Likert scale to the following questions, "This advertising makes me feel like involving green", "This advertising makes me want to buy and recycle cans and bottles", "This advertising made me satisfied with involving green by showing the data of recycling". The Cronbach's α measured for attitude toward green is 0.891.

Purchasing Intention

We also measured subjects' purchasing intention following the rules of Likert scale, which include "I'll continue buying this product", "I think it worth buying", "I'm willing to buy their product because of the advertising of no driving after drinking", "I'm willing to buy their product, due to their encouragement of green", "I'll keep buying their products during the next year". The Cronbach's α analysis result of questionnaires for investigating the subjects' purchasing intention is 0.857.

The Procedure of Data Collection

First of all, regarding consumer characteristics, we adopted factor analysis to figure out the related factors of green value depending on the factor of consumers' value. Furthermore, regression analysis was utilized to find the influent factors of green attitude and green purchasing attitude.

Moreover, regarding green marketing characteristics, we used t-test method for analyzing the relationship between the green marketing and advertising attitude. Meanwhile, the differences of demographic characteristics due to green attitude were also analyzed in t-test.

At last, the influence of purchasing intention resulted from green advertising attitude and green attitude are analyzed and discussed respectively in t-test as well.

Table 4. Analysis of personal value factors

Factor	Question	Factor loadings			
Kind behavior	1. hardworking	0.763			
	2. loyal to people	0.728			
	3. polite	0.771			
	4. responsibility	0.743			
	5. honest	0.711			
Power	6. power	0.922			
	7. high social stratification	0.902			
	8. wealth	0.653			
Safety	9. family safety	0.832			
	10. social security	0.811			
	11. national security	0.801			
Achievement	12. achieve the goal	0.862			
	13. competent	0.732			
	14. ambitious	0.623			
	15. influence	0.654			
Eigenvalues	5.026	2.301	1.654	1.513	
Cumulative interpretation of variance (%)	22.137	38.83	53.28	68.122	
KMO value: 0.823		Significance: $p=0.000 < 0.05$			

DATA ANALYSIS AND RESULTS

Factor Analysis of Personal Value

We adopted the algorithm of principle component analysis (PCA) and the parameter of Varimax to extract the main factor from the raw data of questionnaires as shown in [Table 4](#).

The principle of the factor extraction is that eigenvalue must be higher than 1 and the absolute value of factor loading should be higher than 0.6.

According to the result of factor analysis and extraction principle, we got four value factors which include Kind Behavior, Power, Safety and Achievement as shown in [Figure 3](#).

After analysis of personal value factors shown in [Table 4](#), we extracted four value factors to further inference the reliability analysis.

Regarding the result of reliability analysis, the important parameters Cronbach's α representing reliability value for different factors are 0.879, 0.786, 0.781 and 0.803 for the corresponding factor of Kind Behavior, Power, Safety and Achievement respectively. We can see all of Cronbach's α for different factors are higher than 0.7 which mean the values of reliability are good in this research.

The result of reliability analysis shows that consumers with different genders, ages and revenues whose consuming behavior have no differences on green marketing ($p=0.654$). However, different education levels of consumers could result in significant difference on green attitude ($p < 0.05$).

After Scheffe test, we found that consumers with graduate school level are higher than consumers with senior and junior school, which means that consumers with higher education level have higher green attitude.

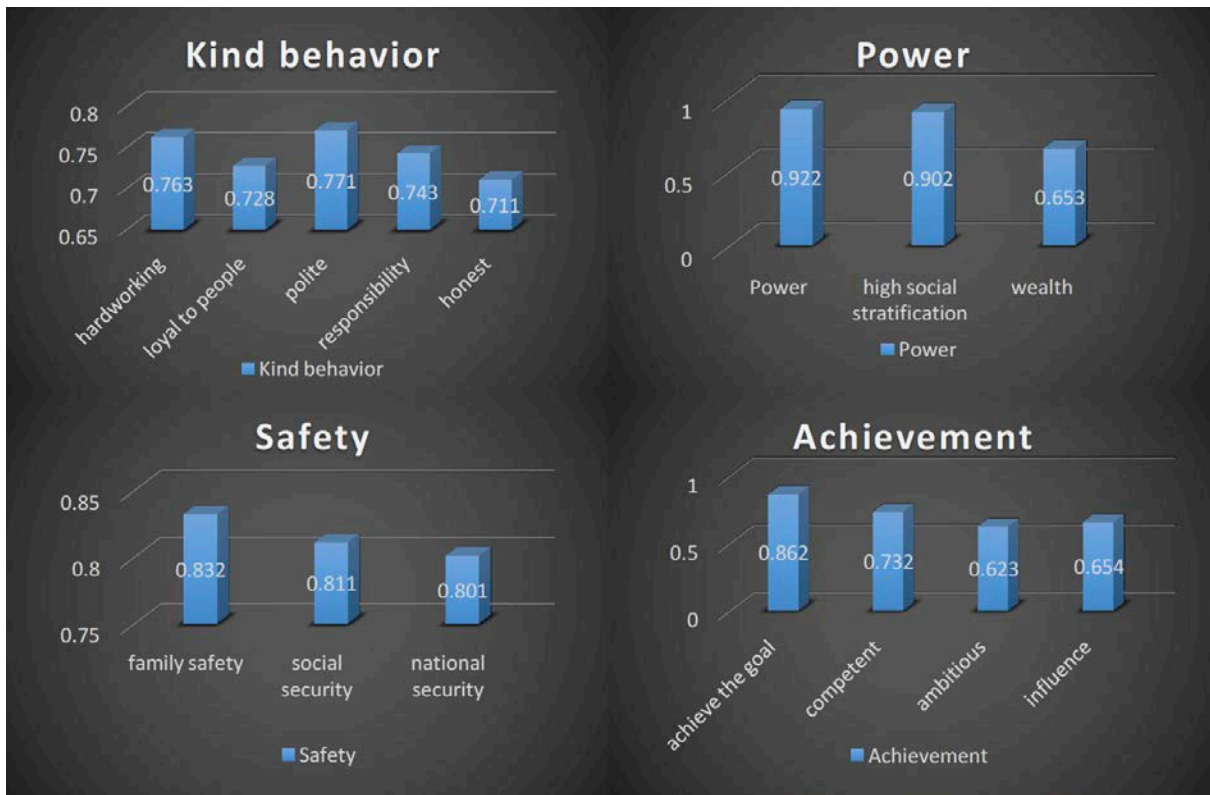

Figure 3. Analysis of personal four value factors including Kind behavior, Power, Safety and Achievement

Table 5. Advertising attitude of consumer and environmental protection attitude of consumer after regression analysis

	Mode one	Mode two
Advertising attitude of customer	0.331***	--
Environmental protection attitude of consumer	--	0.273***
Constant term	13.812***	12.892***
R ²	0.146	0.071
F	54.212	24.217

Dependent variable: purchase intention

REGRESSION ANALYSIS

The Regression Analysis for Advertising Attitude to Purchasing Intention of Consumer

According to the result of regression analysis, we can see great influence on advertising attitude to purchasing intention of consumer ($p < 0.05$; $F = 54.212$, variable $R^2 = 14.6\%$).

The Regression Analysis for Environmental Protection Attitude to Purchasing Intention of Consumer

According to the result of regression analysis, we can see green attitude has a great impact to purchasing intention ($p < 0.05$; $F = 24.217$, variable $R^2 = 7.1\%$).

CONCLUSIONS AND RECOMMENDATIONS

The IoT is a new and effective integrated technology based on internet, including hardware, software and firmware. The applications of IoT will be promoted all over the world without time and space constraints in the future. The IoT can let the automatic machine interactively communicate with consumers and raise consumer involvement to deepen consumers' impressions and increase consumers' purchasing power (Ian G Smith, 2012).

According to the results of single factor variance analysis, the most important factor affecting consumers' green attitudes is education. Especially, we found the trend that consumers with graduate school or higher education level, they usually have more social responsibility and are easier to accept the concept of IoT with green marketing. Case study and focus group are adopted for experiment and analysis. After qualitative analysis, we use factor analysis and regression analysis to analyze the statistical results of questionnaires. The effective questionnaires returned rate of this research is 282/300(94%). The analysis results of Likert scale show that Cronbach's α for 5 factors are all higher than 0.7 which means the reliability of this research is good. The results show that the green attitude of consumer has a significant impact to his/her own purchasing intention. The consumers are aware that green products, green information, and the importance of the ecological environment will affect the attitude of consumers on green life, thereby affect the purchasing intention (Hui-Hsin Huang, 2015).

The study found that green marketing via the IoT is the new perspective for education thinking. This is a rare combination issue in the past research. Therefore, the actual case study in Taiwan is still not mature. Nevertheless, this study still gets the conclusion, the advertising attitude of consumer affects purchasing intention of green products obviously. When the consumer has better advertising attitude and perspective about advertising with some green information, as a result, it can not only promote consumer to search the related information of green product and enhance the purchasing intention, but also a good way for the consumer's green education.

According to the research results, we can prove that the following hypotheses are valid.

H01: The higher degree of education, the higher degree of environmental protection.

H02: The advertising attitude has the positive impact to purchasing intention of consumer.

H03: Environmental attitude of consumer has the positive impact to the purchasing intention.

H04: Green marketing interactions with consumers via the IoT has the positive effect of green education.

It is recommended that the green marketing related enterprises have to make good use of their own professional technology via the IoT, and combine with integrated innovations to promote their green related products. Based on contingency theory and information processing theory, communication medium are generally more effective for communication of equivocal issues. It will be the responsibility of enterprise to utilize the new technology of IoT. This research offer a new marketing model to take the advantage of preemptive opportunities and create the multi-win situation for businesses, consumers, governments and our earth in the future.

ACKNOWLEDGEMENTS

The author(s) disclosed receipt of the following financial support for the research, authorship, and/or publication of this article: The authors would like to appreciate the Ministry of Science and Technology of the Republic of China, Taiwan, for financially supporting this research under Contracts MOST 105-2221-E-218-027 & MOST 106 -2221 -E-218-017.

REFERENCES

- Alfredsson, E. C., (2004). "Green" consumption – no solution for climate change. *Energy*, 29(4), 513-524.
 Atzori, L., Iera, A., & Morabito, G. (2010). The Internet of Things: A survey. *Computer Networks*, 54(15), 2787-2805.

- Burton, S., & Lichtenstein, D. R. (1988). The effect of Ad claims and Ad context on attitude toward the advertisement. *Journal of Advertising*, 17(1), 3-11.
- Chien, Y. (2011). *A Study of the Tendency about Green Consumption towards the Recognition of Food Green Marketing and the Patterns of LOHAS*.
- Daft, R. L., & Lengel, R. H. (1986). Organizational Information Requirements, Media Richness and Structural Design. *Management Science*, 32(5), 554-571.
- Fleisch, E. (2010). What is the internet of things - an economic perspective Auto-ID Labs? *White Paper WP-BIZAPP-053: Information and Technology Management - University of St. Gallen*.
- Fraj, E., & Martinez, E., (2006). Environmental values and lifestyles as determining factors of ecological consumer behaviour: An empirical analysis. *The Journal of Consumer Marketing*, 23(3), 133-144.
- Huang, H.-H. (2015). From the perspective of ecological benefits to explore the characteristics of green advertising and consumer characteristics for buying green products. *Web Journal of Chinese Management Review*, 18(1).
- Hung, W.-C. (2016). *A Design of Internet of Things Security Monitoring System for Smart Home*.
- iThome. (2015), Retrieved from: <http://www.ithome.com.tw/news/99919>
- Larijani, M., & Yeshodhara, K., (2008). An empirical study of environmental attitude among higher primary school teachers of India and Iran. *Journal of Human Ecology*, 24(3), 195-200.
- Lewis, D., & Bridger, D. (2001). *The soul of the new consumer: authenticity we buy and why in the new economy*.
- Mehta, A., (2000). Advertising attitudes and advertising effectiveness. *Journal of Advertising Research*, 40(3), 67-72.
- Ottman, J. A., (1999). *Green marketing: Opportunity for innovation*. Raleigh.
- Poja (2016), Retrieved from: <http://www.poja.com.tw/news/life/2016-09-01/9213.html>
- Roseland, M. (2012). *Toward sustainable communities: Solutions for citizens and their governments (Vol. 6)*. New Society Publishers.
- Schiffman, L. G., & Kanuk, L. L. (2007). *Consumer Behavior, 9th Edn*. New Jersey: Prentice Hall.
- Schwartz, S. H. (1992). Universals in the content and structure of values: Theoretical advances and empirical test in 20 countries. *Advances in Experimental Social Psychology*, 25, 1-65.
- Smith, I. G. (2012). *The Internet of Things*. New Horizon: IERC.
- Stewart, D. W., & Shamdasani, P. N. (1990). *Focus groups: Theory and practice*. London: Sage.
- Weber, R. H. (2010). Internet of Things - New security and privacy challenges. *Computer Law & Security Review*, 26(1), 23-30.
- Yen, Y.-R. (2007). *A Study of the Advertising Messages Communication Mode by Using Interactive Media in Public Spheres*.

APPENDIX

Questionnaire 1

1. If the same price of products with different brands, would you like to choose the product with an interactive advertising?
2. Why do you choose an interactive advertising brand to buy?
3. If the same price of products with different brands, would you like to choose the product with green messages?
4. What's your concern about environmental protection?
5. Do you have the impression of the enterprise which has the interactive advertising case?
6. Do you think that the product with green message is the better?
7. There are two products, one has interactive advertising with green message the other just has interactive advertising, which product you want to buy?
8. If there is a product related with environmental protection and health, would you like to buy this kind of environment friendly goods?

Questionnaire 2

1. Gender : ___ (1) Male (2) Female (3) Other___.
2. Age : ___
3. Education level : ___ (1) Illiterate (2) Primary school (3) Junior high school (4) High school (5) Bachelor degree (6) Master degree (7) Ph.D. degree (8) Other___.
4. Performance : ___ (1) No (2) Full-time job (3) Part-time job (4) Other___.
5. Average monthly income for the last year.__(1) No (2) Below NT\$20,000 (3) NT\$20,000- NT\$29,999 (4) NT\$30,000- NT\$39,999 (5) NT\$40,000- NT\$49,999 (6) NT\$50,000- NT\$59,999 (7) NT\$60,000- NT\$69,999 (8) NT\$70,000- NT\$79,999 (9) NT\$80,000- NT\$89,999 (10) NT\$90,000- NT\$99,999 (11) Above NT\$100,000

<http://www.ejmste.com>



For print copies of this issue or articles please send an e-mail to:

print@modestum.co.uk



Scientific Disciplines of Geojunggi (the Traditional Crane) in Korean Science, Technology and History Class

Pyoung Won Kim

Incheon National University, Republic of Korea

Received 7 April 2017 • Revised 27 June 2017 • Accepted 24 August 2017

ABSTRACT

The purpose of this article is to provide applicable instructional strategy for teachers and researchers, which reflects the history of the exchange of science and technology between the West and the East. This research had as its foundation the mechanical drawings of Gigidoseol [Strange machines from the far West], Hwaseongseongyeoguigwe [A completion report for the Construction of Hwaseong Fortress]. This study provides science and technology teachers with a detailed instructional strategy to explain the traditional block-and-tackle and gear mechanisms. The examples of traditional mechanical drawings introduced in this paper will complement science and technology class materials. The core principle of traditional mechanical drawing based education is to utilize the traditional sciences as a medium that connects Science, Technology and History.

Keywords: Geojunggi, the mechanical drawings, science, technology, history

INTRODUCTION

Chong Yagyong, whose pen name was Tasan (茶山, Tea Mountain), is widely known as a great Korean writer who compiled the Silhak (practical studies) during the late Joseon Dynasty of Korea (Moon, 2013). But the capability that distinguished himself during the time period of his being in a public office was the field of engineering (Lee 2012, 53-54). Hwaseong Fortress is the wall surrounding the center of Suwon city, the provincial capital of Kyonggi-do, South Korea. The site was designated as a World Heritage site by the UNESCO in 1997. Chong Yagyong is an architectural construction engineer who designed the Hwaseong Fortress. And, at the same time, he is the mechanical engineer who developed the Geojunggi (舉重機, loader crane) and the Nongno (轉轆, jip crane).

Geojunggi is a device that symbolizes the Silhak of the late Joseon Dynasty which appears without missing any of the discussions related to the Hwaseong Fortress and Chong Yagyong (KAWAHARA 2008, 69). In a lot of the literatures, including the textbooks, Geojunggi has been described as a crane for building the castle walls.

In Korean history and science classes, many students ask how the Geojunggi operates and lifts stones. However, teachers cannot provide clear answers. In addition, the textbook does not explain exactly how to build a wall using a Geojunggi. Teachers' explanations are unclear, and they often embellish their answers with imaginative additions that are not factual. Korean schools claim that using the Geojunggi, the time required to construct the Hwaseong Fortress, which was planned to be 10 years, could be shortened to less than three years. However, this is not true.

In the existing literature, researchers have added their views and included traditional mechanical drawings. However, such studies rarely examine the specific process of developing machines. This paper provides

© **Authors.** Terms and conditions of Creative Commons Attribution 4.0 International (CC BY 4.0) apply.

Correspondence: Pyoung Won Kim, A-215 Michuhol campus, Incheon National University, 12 Gaetbeol-ro, Yeonsu-gu, Incheon, Korea (the Republic of), 21999, Tel: +82-32-835-8829.

✉ pwkim@inu.ac.kr

State of the literature

- Throughout STS (Science, Technology and Society), STEM (Science, Technology, Engineering and Mathematics) & STEAM (STEM+Art), Korea has been steadily adopting scientific educational movements to grow the Competence of Convergent Human Resources.
- Although many educational researchers have been developing STEAM educational programs, there have been their limits, as a Humanities field was regarded as Art courses or excluded at all from the courses.
- In the existing literature, researchers have added their views and included traditional mechanical drawings. However, such studies rarely examine the specific process of developing machines.

Contribution of this paper to the literature

- This paper provides science and technology teachers with a detailed instructional strategy to explain the traditional block-and-tackle and gear mechanisms.
- The examples of traditional mechanical drawings introduced in this paper will complement science and technology class materials.
- The educational program that combines History and Science and Technology provides supports for teachers & researchers to discover and develop effective, applicable STEAM education contents.

science and technology teachers with a detailed instructional strategy to explain the block-and-tackle and gear mechanisms.

The purpose of this article is to feasibly infer the specific method of using the Geojunggi based on the literature referred to during the process of the development of the Geojunggi on the part of Chong Yagyong and the mechanical drawings he left behind. For this, first, the Gigidoseol (器機圖說, Strange machines from the far West) by Wang Zheng (1571-1644) & Joannes Terrenz Schreck (Chinese name is Deng Yuhan 鄧玉函, 1576-1630), which Chong Yagyong referred to was analyzed (Chong 2007, 99). Based on this, the Tasansimunjip (茶山詩文集, Collection of Tasan Chong yakyong's poetry and prose), which gathered the writings left behind by Chong Yagyong and the Hwaseongseongyeoguigwe (華城城役儀軌, A completion report for the Construction of Hwaseong Fortress), which is the national white paper, were comparatively analyzed (King Sunjo, 1801).

THE HANDLING METHOD FOR GEOJUNGGI AS MENTIONED IN THE LITERATURE

Hwaseongseongyeoguigwe was the 10-volume White Paper on Hwaseong Fortress Construction. The book was a decisive source of information for Hwaseong Fortress Construction. The first volume contains an architectural plan accompanied by drawings of details. Although the whole and the part drawings of Geojunggi are introduced in the first volume among the Hwaseongseongyeoguigwe's. However, there were no mentions on the use at all (Figure 1).

Regarding the use of the Geojunggi, it is mentioned that the reason why the machines that lift the heavy things and the Yuhyeonggeo (carts) were used was that it was a system with which the carriage is convenient in the Hwaseonggijeokbi (火城記蹟碑, a memorial stone for the Construction of Hwaseong Fortress) among the Hwaseongseongyeoguigwe's (King Sunjo, 1801). Although, regarding this construction monument, Kim Chongsu (1728-1799) wrote the draft following the order by King Jeongjo (1776-1800) in 1797, due to King Jeongjo's sudden death in 1800, it could not be erected and it has existed as the words within the Hwaseongseongyeoguigwe. In December 1991, in the Suwon City, a monument was made in the Changan Park and the contents written in the Hwaseongseongyeoguigwe were engraved on the tombstone just the way they were. The part that mentioned the purpose of making the Geojunggi and the cart has been engraved on the right side of the lower part of the backside of the tombstone.

Until now, the specific use of the Geojunggi could not receive the attention because it is simply mentioned in the writing on the monument. However, in the Hwaseongseongyeoguigwe, which is the most authoritative source on the construction of the Hwaseong Fortress, it is clearly and distinctly stated that the Geojunggi had been used as a transportation system that was used to convey the construction materials. If the monument was erected

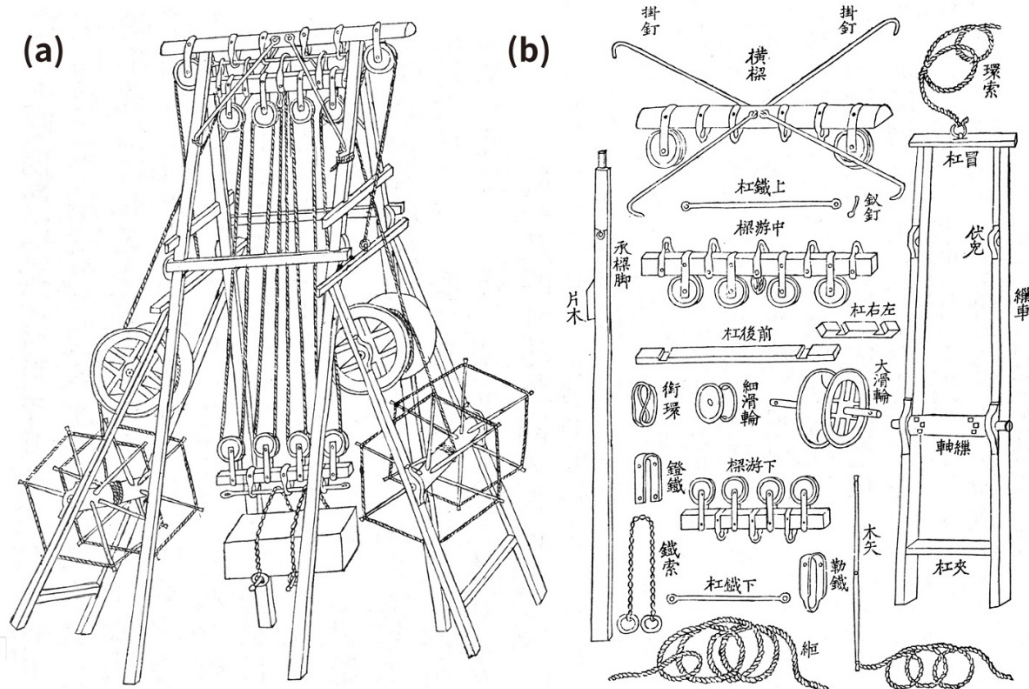

Figure 1. The Whole drawings of Geojunggi (a) and the part drawings of Geojunggi (b) Geojunggi was used in the construction of Hwaseong Fortress walls. (Reprinted, with permission of Seoul National University Kyujanggak Institute for Korean Studies.)

right after the completion of the Hwaseong Fortress Construction, the accurate use of the Geojunggi would have been conveyed widely.

THE CONSTRUCTION METHOD FOR THE CASTLE WALLS OF THE HWASEONG FORTRESS

Seongseol (城說) is the master plan on the construction of the Hwaseong Fortress, which was written by Chong Yagyong (Chong, 1792). It is organized with a total of 8 construction strategies, including 1 on the size, 1 on the materials, 4 on the engineering methods, and 2 on the transportation strategies. By examining the strong points and the weak points of the existing Joseon castles system and, also, by researching the castles system of China, a castle suitable for the Hwaseong Fortress was designed (Noh 2007, 150). It was in the winter of the year 1792, more than 1 year before the construction of the Hwaseong Fortress, that Chong Yagyong presented the Seongseol to The King Jeongjo. The King Jeongjo announced the plans for a new construction that was Eojeseonghwajuryak (御製城華籌略).

The best method for building the castle walls is the in & out stone-filling construction method, which piles up the stones both on the inside and on the outside. Although Chong Yagyong said, “Regarding the castles, building them on the inside and the outside simultaneously is originally the best thing”, this was not reflected with the Hwaseong Fortress (Chong, 1792). Although the engineering method of building both the inside and the outside has the strong point of building the strong castle walls, a lot of the costs are needed (Kim 2012, 66). As such, the construction becomes difficult. After the castle walls have been built, a construction that does away with the soil slope ways must be carried out additionally.

In order to shorten the construction duration period in an in & out stone-filling construction method, there are the limitations when using the soil slope method (Song, 2009). Instead, a lot of the jib cranes must be

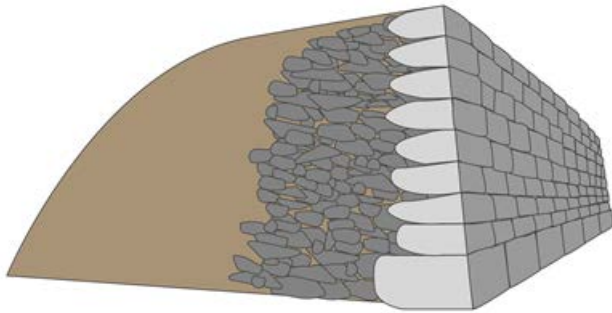

Figure 2. Cross section of fortress wall built in a Soil-in & Stone-out construction method. (Created by the author)

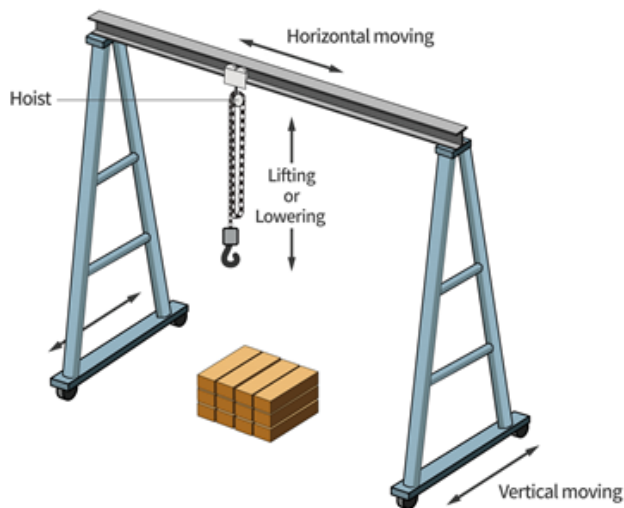

Figure 3. The degree of freedom (DOF) of a mechanical system is the number of independent parameters that define its configuration. Hoist Gantry Crane is the three-degree-of-freedom control system. (Created by the author)

simultaneously mobilized to build while lifting the stones. Because, at the Hwaseong Fortress construction site, two units of the Nongno and one unit of the Geojunggi were used, it cannot be considered that the cranes were used for the task of building the castle walls.

According to the Seongseol, regarding the Hwaseong Fortress walls, the outside was piled up with the stones and the inside was built with the construction method of tramping and putting in the small stones and the soil (Chong, 1792). The soil-in & stone-out construction method built the castle walls in the method of pulling and carrying the stones after the slopes were made and hardened by using the soil that came out after digging the moats (Figure 2). As a result, the cranes like Nongno and Geojunggi are not needed. Also, as the soil slope ways used for carrying the stones are utilized by hardening them just the way they are, there is no need to remove the soil slope ways after finishing the construction.

MACHINE STRUCTURE OF GEOJUNGGI

The form of the Geojunggi is similar to the modern overhead crane which is equipped with the hoist on the gantry. But Geojunggi is the one degree of freedom (DOF) control system (Figure 3). Only the lifting or the lowering are possible and the vertical moving is not possible. And, with regard to the point that the horizontal moving is not possible after lifting up, there are no big differences in terms of the functions. For the vertical moving



Figure 4. Pulley System of Geojunggi (a) and the construction of fortress walls utilizing Geojunggi (b). (Created by the author)

to be possible, there must be the wheels on the legs of the gantry. And, in order for the horizontal moving to be possible, the hoist must move on the running rail as Hoist Gantry Crane.

Although the height of the Geojunggi is approximately 4.4m, when considering the special, structural characteristics, the maximum height of the lifting up of the stones is merely around 3m. This is because, in the space below the Parallel Beam (橫梁), a space for fixed pulley block (中遊梁) and Movable pulley block (下遊梁) to meet is needed. As Chong Yagyong designed the height of the castle walls to be approximately two jang (丈) five cheok (尺) (about 7.75m), the Geojunggi cannot be used for building the castle walls that are higher than 3m (Chong, 1792).

As, regarding the method of the construction of a castle utilizing the Geojunggi, it is not mentioned in any literature, in order to prove that the castle walls were built, the feasible method of lifting the stones and then relocating the stones to the castle walls must be presented. Ordinarily, regarding the pallets, the case of conjecturing that the upper part of the Geojunggi and the castle walls are connected and the stones are relocated is general (Figure 4).

But, in this case, the more the stones are lifted, the center of the gravity height (the center of the weight) of the Geojunggi moves to the above. And, if the stones are moved in the condition in which the center of the gravity height has moved to the above, there is the big possibility that the Geojunggi will be overturned.

Moving around the Hwaseong Fortress construction site, which reaches 188,048 m², and using only one unit of the Geojunggi is inefficient. This is because the Geojunggi is not a machine that was designed by considering the movability. In the Whole and the Part Drawings of Geojunggi by Hwaseongseongyeoigwewe, there are no components with regard to which the movabilities, like the wheels, were considered at all. Although it can be seen that the reason behind the presentation of the part drawings is for the disassembly and the assembly, when considering the complicated assembly process in which a lot of the sheaves must be connected to the lines, dismantling and assembling frequently is inefficient.

BLOCK-AND-TACKLE MECHANISM

Pulley System is a combination of sheaves and ropes often used for lifting. The block-and-tackle mechanism is a phenomenon that has been discovered here and there in the East and the West simultaneously over many generations. Already, from the days of ancient Greece and Rome, the cities had been constructed by mobilizing the large-sized cranes. During the long time from the ancient times to the modern times, the many people in each of the countries in the world developed the Geojunggi. Although, in Korea, it is known that Chong Yagyong invented the Geojunggi, it was not an invention of a new thing that did not exist before, but, it was the improvement of a previously existent thing so that it fits our actual circumstances. Da Vinci (Leonardo di ser Piero da Vinci, 1452-1519), designed a crane utilizing the block-and-tackle mechanism around 300 years before the Chong Yagyong (Figure 5).

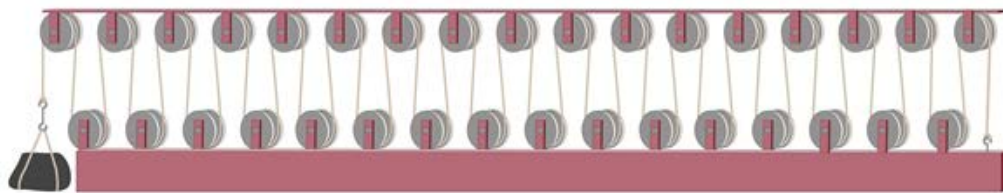

Figure 5. The Design of Crane that Davinci left as a sketch. Davinci's crane was organized with 16 movable pulleys and 17 fixed pulleys. (Created by the author)

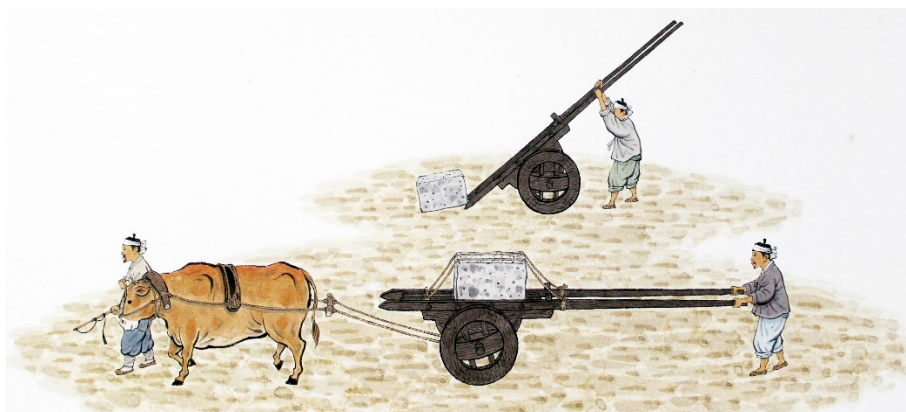

Figure 6. Newly designed wheeled cart, Yuhyeonggeo (遊衡車). (Created by the author)

Chong Yagyong recorded, in detail, the process of developing the Geojunggi in the Gijungdoseol (起重架圖說, Technical drawing of prototype) together with the pictures (Chong, 1983). Chong Yagyong's Geojunggi is a block-and-tackle mechanism which uses 8 pulleys. The block-and-tackle mechanism that Chong Yagyong and Davinci designed has the same mechanical principles. There is only the difference in terms of the method of rolling up.

Although, in Davinci's drawing, there is the rolling up only on one side, the Geojunggi by Chong Yagyong was designed so that there are the rolling ups on both sides. As Davinci's sketch expressed only the principle of the machine, it has been restored to the diverse methods today. But, as the components organizing the device of the Geojunggi by Chong Yagyong were systematically arranged, they can be restored to their appearances at the time of the late Joseon period.

While giving the Gigidoseol by Wang Zheng & Joannes Terrenze Schreck to Chong Yagyong, The King Chong Cho gave the instruction that both the Hoist (起重器) and the Winch (引重器) get developed. The Gigidoseol by Terrenz, which was published in 1627, is a book that organized the drawings of the diverse machines together with the simple explanations (Wang, Z. & Schreck, J. T., 1627). It is an introduction of the machines that were improved by comprehensively analyzing the machines that have been passed on, including the ancient construction equipments. In the Gigidoseol, 11 mechanical drawings of the hoists (起重圖) and 4 mechanical drawings of the winches (引重圖) were presented. The hoist rolls up the string in the direction that is opposite the gravity. And the winch rolls up the string in the direction that is parallel to the gravity.

Chong Yagyong did not develop the winch that pertains to the winch and concentrated on the development of the winch (Chong, 1783). It looks as though the reason is that, as the efforts and the costs for producing the winch are formidable, it was judged that the method of using the carts is more efficient (Figure 6). In fact, even though The King Jeongjo did not instruct it, Chong Yagyong developed the Yuhyeonggeo (遊衡車, a cart that shakes like the scale).

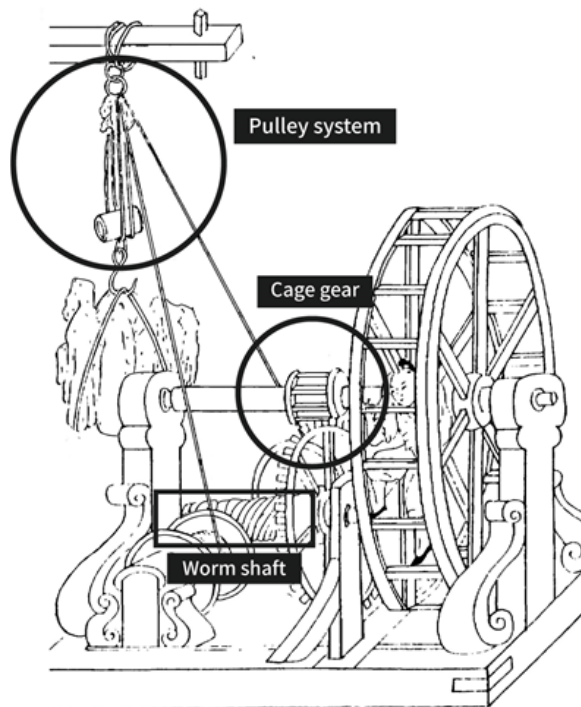

Figure 7. The 10th mechanical drawing of hoist. (起重第十圖)

(Reprinted, with permission of Seoul National University Kyujanggak Institute for Korean Studies.)

Among the mechanical drawings by Gigidoseol, Chong Yagyong evaluated the 10th mechanical drawing of the hoist as the most precise and mysterious machine (Figure 7). The 10th mechanical drawing of the hoist expresses the mechanism in which, if a person goes into a large-sized wheel and rotates the wheel like a squirrel rotating a treadwheel, a gear connected to the wheel rolls up the string connected to the block-and-tackle. As such, the method in which a person goes into a wheel hub and rotates the wheel and creates the power of the wheel was not first proposed in the Gigidoseol by Terrenz, but it is a method that had already been widely used with regard to the Roman treadwheel crane (Wang, Z. & Schreck, J. T., 1627).

The principle of the 10th mechanical drawing of the hoist is very similar with the Roman treadwheel crane with regard to the point that it uses the block-and-tackle mechanism and the treadwheel (Figure 8). But, it developed more than the Roman treadwheel crane with regard to the point that the size of the treadwheel was reduced by improving so that the power is efficiently delivered by utilizing the worm gear and the cage gear. We can find out that, according to the Gijunggadoseol, Chong Yagyong had a deep interest in the 10th mechanical drawing of the hoist.

When Chong Yagyong took a look at the methods for pulling up the heavy things on the Gigidoseol which was handed down by the King, there were 11 in general. But, all of them were not precise. Except, the drawings number 8, number 10, and number 11 were precise and mysterious. However, the drawing number 10 had to have a copper spiral sheave. As such, as I think of it now, even if the engineer is the best in the country, he will not be able to make it. What is more, making a sawtooth on a copper wheel must be difficult (Gijunggadoseol, 1792).

In Institute for the Translation of Korean Classics, in the process of translating the Gijunggadoseol, recorded with Chinese characters, the 銅鐵螺絲轉 was expressed as the copper spiral sheave. But, as Chong Yagyong expresses the sheave as Hwalcha (滑車) or Hwallyun (滑輪), if one considers the context at the front and at the back, it is correct to translate it as the copper spiral shaft.

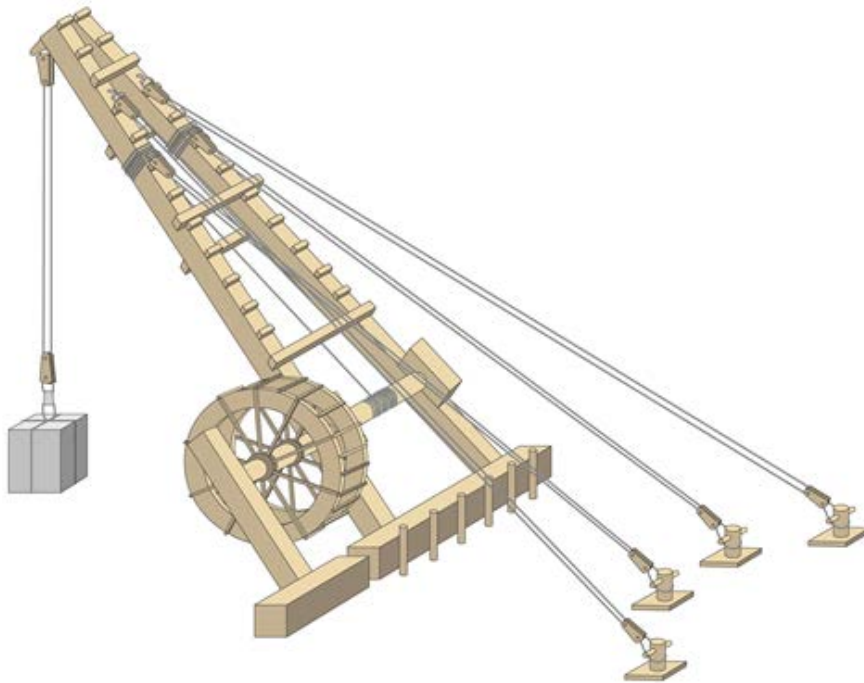

Figure 8. Roman treadwheel crane is a wooden, human powered, hoisting and lowering device. (Created by the author)

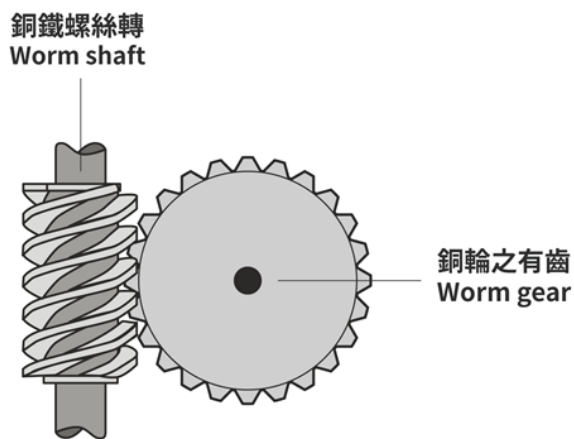

Figure 9. Worms and worm gears are gear sets that offer high gear reduction and torque multiplication with a small footprint. (Created by the author)

Today, the copper spiral shaft pertains to a worm shaft (**Figure 9**). Chong Yagyong judged that making the copper spiral shaft and the copper worm gear used in the 10th mechanical drawing of the hoist will be impossible. The reason why Chong Yagyong made such a negative conclusion was that Terrenz did not draw, in detail, and communicate the part that the worm shaft contacts the worm gear. The worm gear has a long history, but its application has been limited due to its difficulty of manufacturing.

The mechanism of 10th mechanical drawing of hoist is as follows: when one men tread in the large wheel, they cause it to turn together with cage gear. Since the cage gear engages with its rundles the teeth of wheel, it

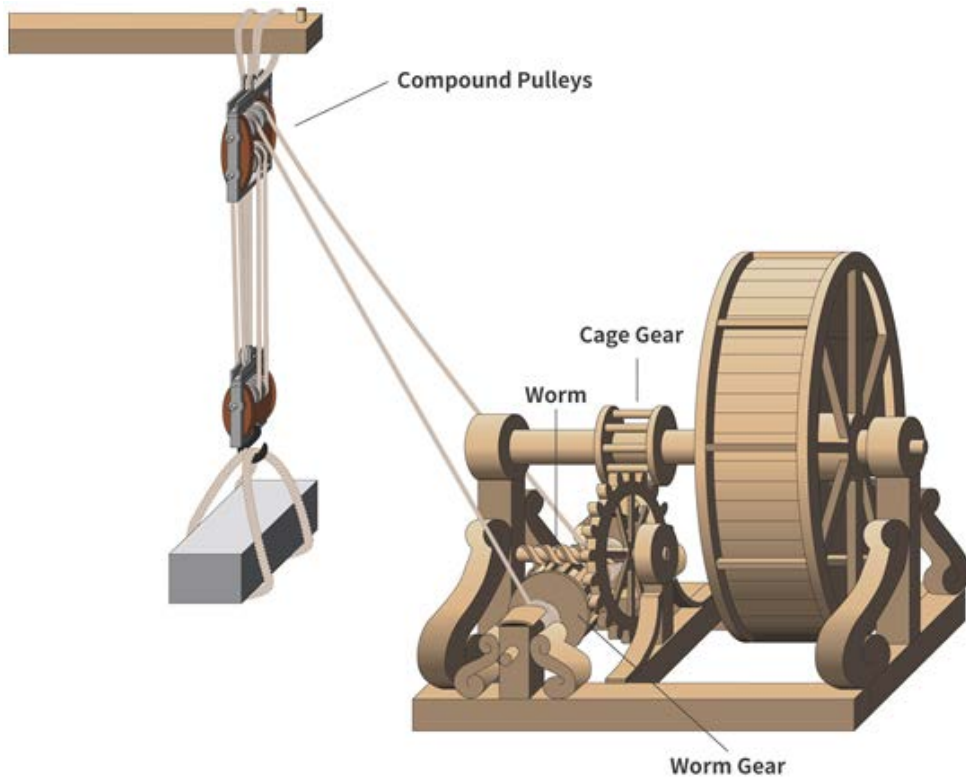

Figure 10. Gear and Pulley System in 10th mechanical drawing of hoist. (Created by the author)

likewise causes this wheel to turn, together with the worm and worm gears causes it to turn with these movements, together with the two drums set on either side of its shaft. These drums wind around themselves the two ends of the rope that passes through the Compound Pulleys (Figure 10).

In fact, with regard to the Gigidoseol, the thing that is not any less important than the gear is the block-and-tackle mechanism. Pulleys grouped together in a single frame make up what is called a pulley block. In the block-and-tackle mechanism, the pulley blocks have been in the pairs. Regarding the pulley blocks, there is the parallel combination method and there is the tandem combination method (Figure 11).

The double parallel pulley block is made of 2 parallel sheaves assembled on a frame. The double tandem pulley block is made of 2 tandem sheaves on a frame. In case the mechanical advantages are the same, there is the strong point that, compared to the tandem pulley block, the space captured by the parallel pulley block is small. Or, in other words, the efficiency of the parallel pulleys method is more extraordinary than the tandem pulleys method, of which the sizes and the weights of the blocks can only increase.

As the parallel pulleys method can make the distance between the pulleys on the fixed blocks of the upper part and the pulleys on the movable blocks in the lower part long, it has the strong point that it can be applied to the jip cranes that pull up the things to the high places. But, there is the weak point that the work of connecting a string to a pulley is somewhat cumbersome.

Terrenz accurately understood and diversely applied the block-and-tackle mechanism (Wang, Z. & Schreck, J. T., 1627). In the case in which, because the copper wires that pull up the things are simple, the strings do not get entangled, the flexibility was exercised in which the pulleys on the fixed blocks were substituted with the steel rings and the pulleys on the movable blocks were substituted with the cylinders. The 10th mechanical drawing of the hoist, referred to by Chong Yagyong, is a pulley system that substituted the pulley blocks with the steel rings and the cylinders for each (Figure 12).

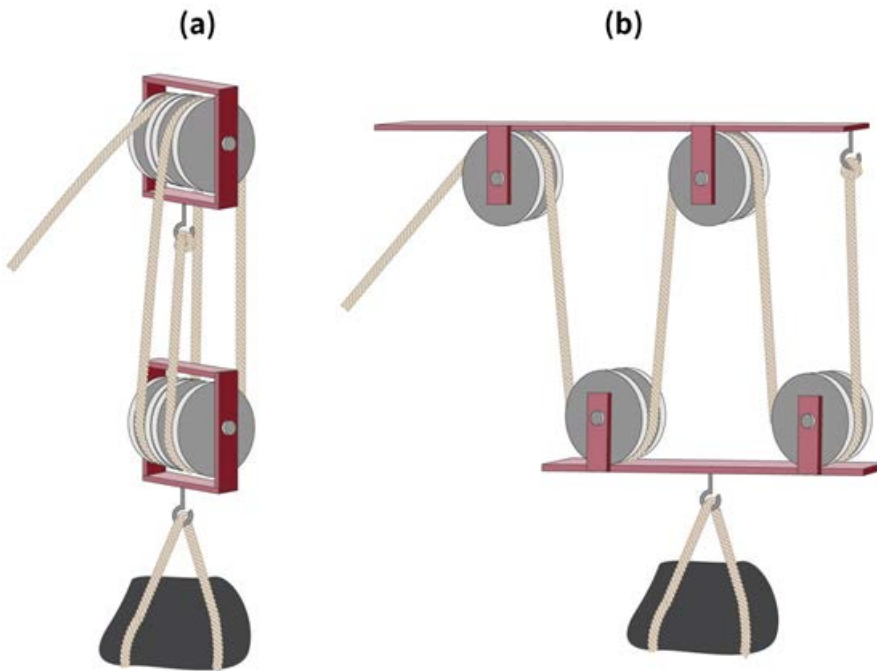

Figure 11. Parallel Pulleys (a) vs Tandem Pulleys (b). (Created by the author)

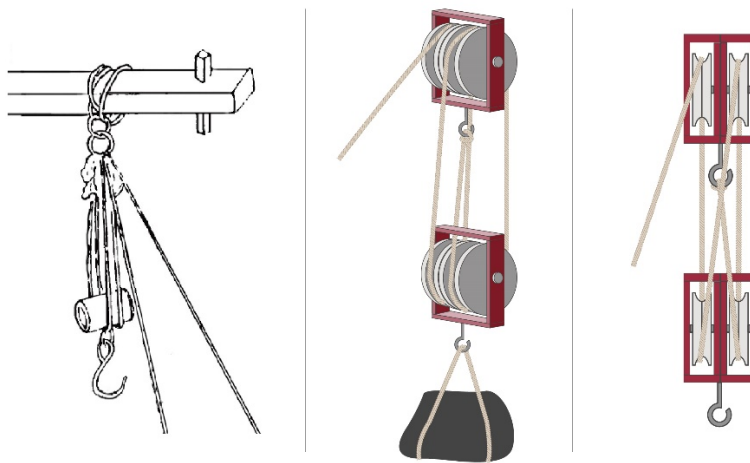

Figure 12. The Pulley System in the 10th mechanical drawing of hoist. (Created by the author)

In this way, the core technology of the block-and-tackle mechanism is the minimization of the space captured by the blocks that combined the pulleys. The 3rd mechanical drawing of the hoist introduced the informal equipment that replaced the pulleys with the steel rings in the so-called “gun tackle method”, organized with the fixed pulleys and the movable pulleys, one for each (Figure 13).

It seems that Chong Yagyong did not consider the point that the sizes of the spaces captured by the pulleys must be reduced by using the parallel pulleys method. The reason is related with the fact that the castle walls of the Hwaseong Fortress were built through the soil-in & stone-out construction method. At the Hwaseong Fortress construction site, the jip cranes that pull up the heavy stones to the high places were not needed, but, the loader

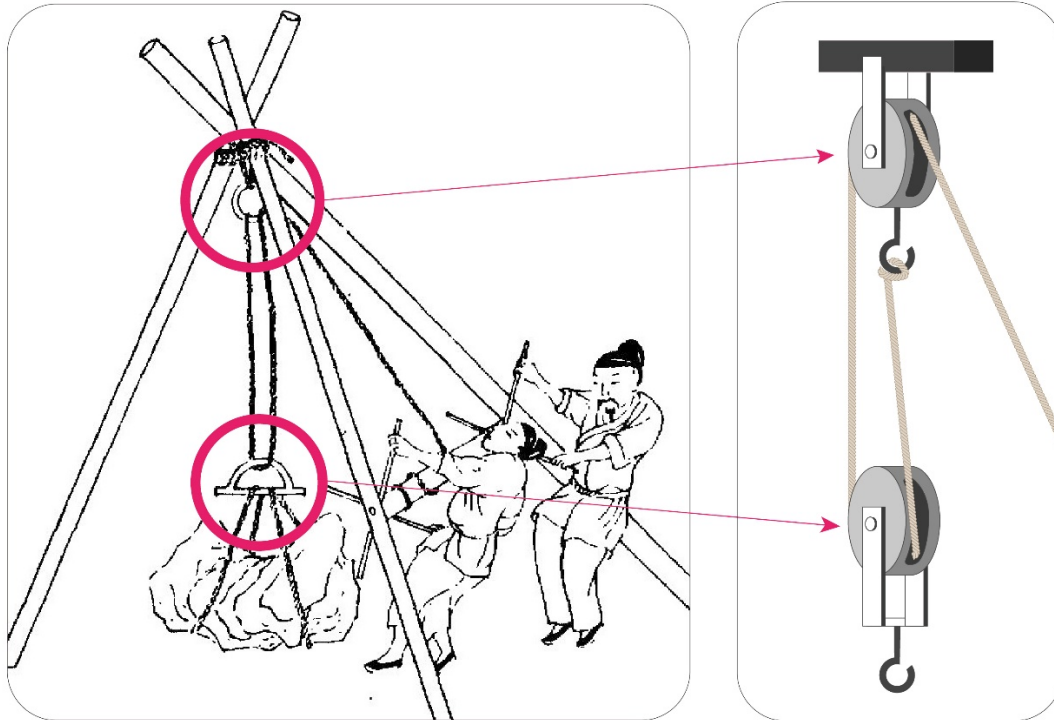

Figure 13. The 3rd mechanical drawing of hoist. (起重第三圖)

(Reprinted, with permission of Seoul National University Kyujanggak Institute for Korean Studies.)

cranes that pull up the heavy stones to the carts were needed. If the in & out stone-filling construction method, which must pull the stones to the high places, was selected, the parallel pulleys method would have been opted for rather than the tandem pulleys method.

Chong Yagyong referred a lot to the 11th mechanical drawing of the hoist. Instead of not using the block-and-tackle mechanism, this mechanical drawing used the double cage gear. This mechanism is a structure in which the people rotate clockwise, wind the winder, delivers the force through the cage gear connected to the winder, and pulls up the things hanging on the fixed pulleys installed on the high places. The cage gears used at this time not only save the force but, also, play the role of a device that prevents the slipperiness (**Figure 14**).

The cage gear is a technology that was used for the Jagyeongnu (自擊漏, water clock), too, by Chang Yeongsil in the beginning of the Joseon period. At the time, it could produce sufficiently with the technologies of the late Joseon period. Despite this, Chong Yagyong did not reflect the double cage gear in the Geojunggi, which he designed himself. This proves that the use of the Geojunggi is not the jip crane that lifts the things to the high places but is the loader crane.

In order to realize the worm gear described in 10th mechanical drawings of a crane, Chong Yagyong called forth a painter and endeavored by drawing in large size. However, eventually, he made the conclusion that it is impossible and abandoned the method of using the worm gear. Instead, it is assumed that the body of the Geojunggi was designed by referring to the 3rd and 6th mechanical drawings of the hoist in the Gigidoseol which pulls up the heavy things by winding the winder (**Figure 15**).

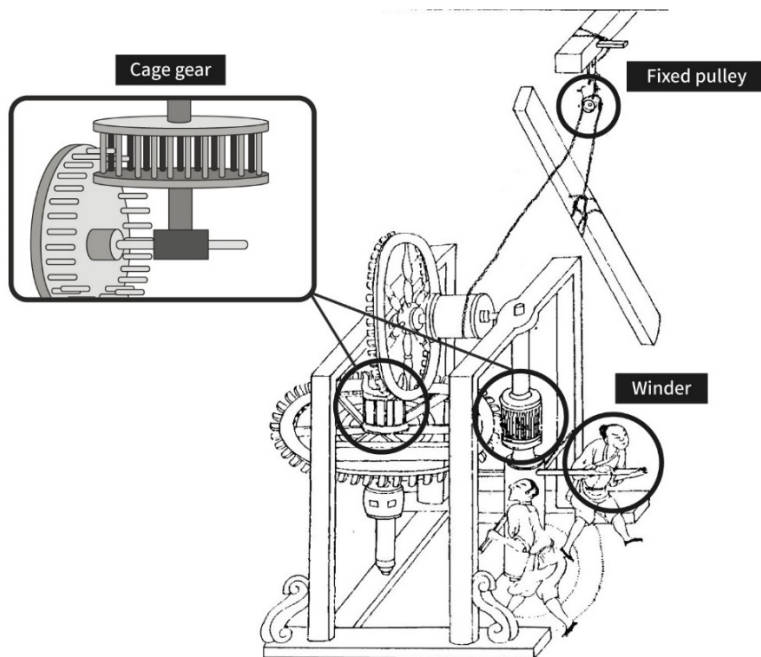

Figure 14. The 11th mechanical drawing of hoist. (起重第十一圖)
(Reprinted, with permission of Seoul National University Kyujanggak Institute for Korean Studies.)

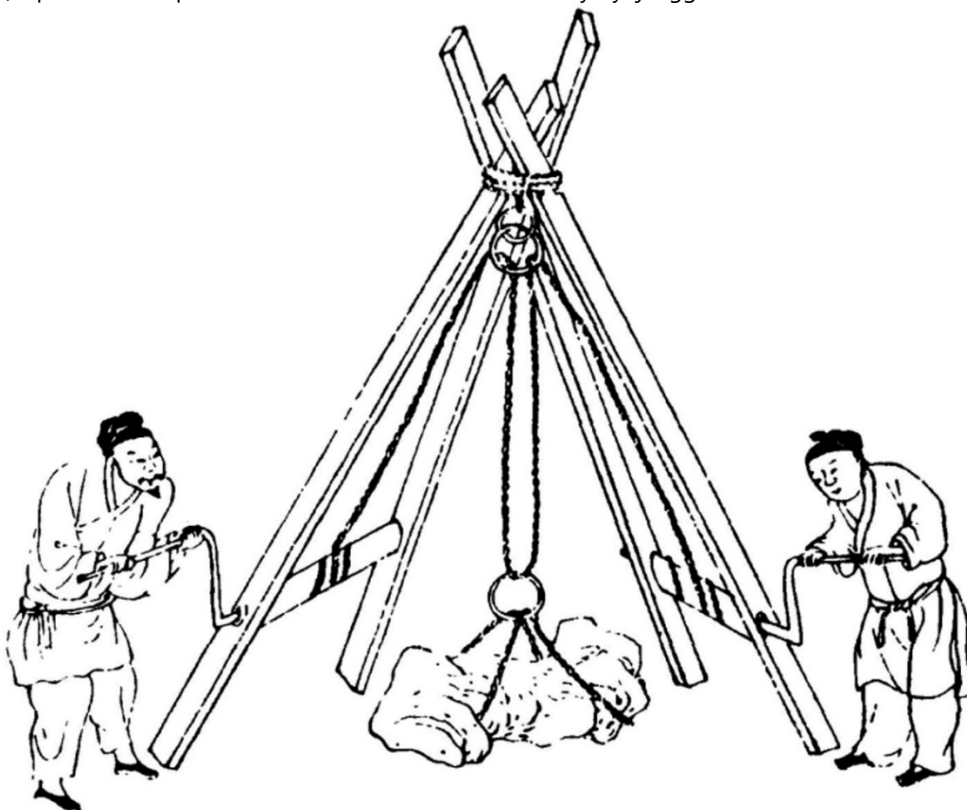

Figure 15. The 6th mechanical drawing of hoist. (起重第六圖)
(Reprinted, with permission of Seoul National University Kyujanggak Institute for Korean Studies.)

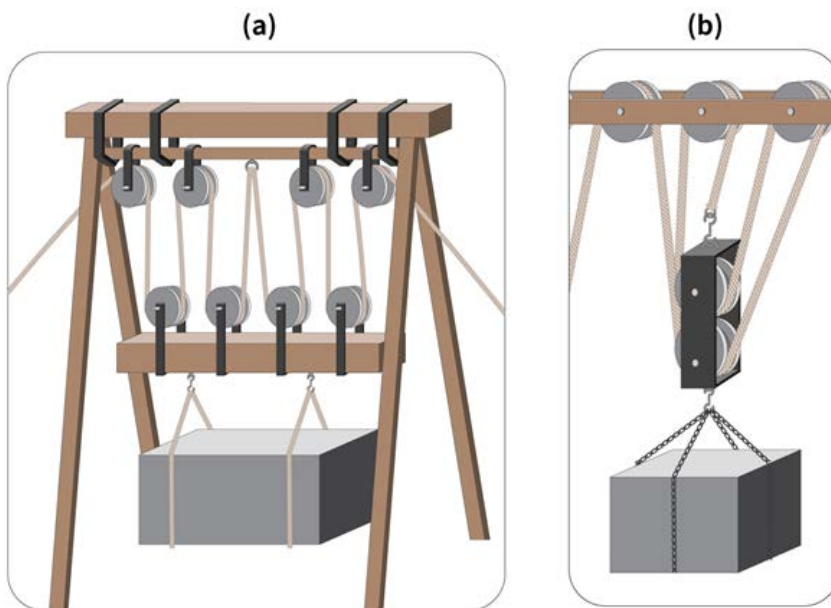

Figure 16. Chong Yagyong's Pulley System (a) vs Terrenz's Pulley System (b). (Created by the author)

Joannes Terrenz Schreck's Pulley System consists of vertical and horizontal tandem block (Figure 16). In comparison, Chong Yagyong's Pulley System consists of two horizontal tandem pulley blocks. One is fixed block (中游樑), the other is movable block (下游樑). As, regarding the horizontal tandem pulleys method, the breadths of the pulley blocks could only be wide, in order to support these, the legs of the supper fixtures, too, increased from three to four.

In this way, Chong Yagyong boldly abandoned the worm gear mechanism and the parallel pulleys method, of which the productions were judged to be not possible with the technologies at the time, by referring to the Gigidoseol. Instead, he adopted the tandem pulleys method as the block-and-tackle mechanism.

THE METHOD OF COMBINING THE SLABS OF THE STONES

Differently from the Gigidoseol by Terrenz and the sketches by Davinci, the Geojunggi by Chong Yagyong subdivided the components so that the disassemblies and the assemblies are easy and simple. And by attaching the names to the components, it produced a manual explaining the role. Especially, regarding the core components, which are difficult to be assembled, they were bundled into one module, thereby heightening the practicality. The movable pulley blocks were modularized by designing so that the small sheaves and the stirrups metals are bundled into one block and so that they are connected to the under steel bars through the rib-pieces (Figure 17).

The excellence of the Geojunggi is the point that it made the method of combining the movable pulley blocks and the stones and dismantling them easy. The method of connecting the stones to the movable pulley blocks is to install the support timbers on the ground, move the stones, and stick the steel bars through the spaces between the timbers. Next, by using the rings to connect the linking chains to the under steel bars and the steel bars, it was made to be easy to combine and dismantle.

Through the method of combining the movable pulley blocks and the stones, too, we can confirm that the Geojunggi is not a construction crane but is an equipment for putting on the stones on the carts. The reason why the chain rings and the steel bars can be easily combined and dismantled is that the stones are put on top of the support timbers. In the case of putting the stones on the stones, it becomes difficult to remove the steel bars under the stones. If we were to organize the method of the use of the Geojunggi in a pictorial manual with the 7 phases based on the above discussions, it is as shown in Figure 18.

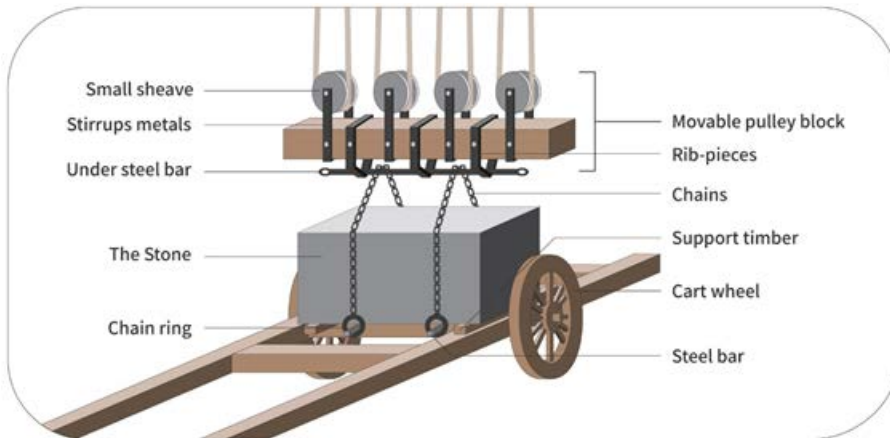

Figure 17. The composition of parts of low pulley block module. (Created by the author)

① Bring the stone below the Kōjunggi by pulling.



② [On the ground] Load the stone on support timbers.



③ Stick the steel bars through the space between the timbers.

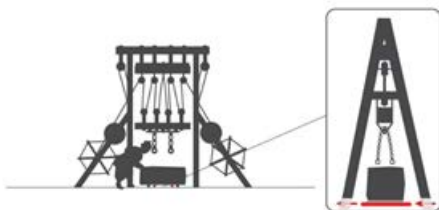

④ Use the rings to connect the linking chains to the under steel bar and the steel bars.



⑤ Lift the stone and place the cart below the Kōjunggi.

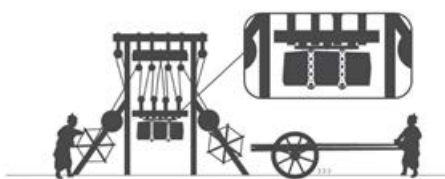

⑥ [On the cart] Load the stone on the support timbers.

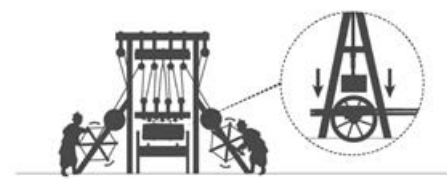

⑦ Untie the linking chains, and move a cart out of the Kōjunggi.



Figure 18. The Process of stone-loading utilizing Geojunggi. (Created by the author)

CONCLUSION

The reason why a lot of people said that the Geojunggi can improve the work efficiency by four times until now is related to the fact that the Hwaseong Fortress, regarding which 10 years were anticipated, actually ended in only two and a half years. Taking out the 6 months during which the construction had been suspended in the hot summer and the cold winter, the construction was finished within only 1/4 of the anticipated time period of the construction.

But, this word is a nonscientific inference and, at the same time, and it is different from the methods of calculating the work efficiencies today. According to the Hwaseongseongyeoguigwe, there was only one unit of the Geojunggi that was actually utilized on the construction site. There is a commonsensical problem with seeing that the time period of the large-sized construction of making the castle walls and the facilities that reach 5.4km was shortened to within 3 years with only one Geojunggi. Despite this, there has not been an example that raised an objection regarding a detail in a textbook and that attempted an analysis in earnest.

There is no accurate record that says that the construction duration period was shortened by using the Geojunggi. Except, there was only the introduction by Chong Yagyong that the construction cost of 40,000 nyang (兩) could be reduced by using a cable driving system with regard to the tombstone which he wrote by himself (Lee 2008, 142). Seeing that it was accurately mentioned that the sum amount of the money of the reduction of the budget was 40,000 nyang (兩, a traditional Korean monetary unit), there is the big possibility that this was the labor cost of the daily laborers who carried the stones. As the 40,000 nyang was merely 4.6% of the total construction cost of the Hwaseong Fortress which was approximately 870,000 nyang, the interpretation that the construction duration period could be shortened by using the Geojunggi is wrong. This is because the reduction of the costs and the reduction of the construction duration period are totally different issues. According to the Hwaseongseongyeoguigwe, the expenditures break down into 320,000 nyang spent on the purchase of construction material, 300,000 nyang for wages, 220,000 nyang for transportation of construction materials, and 90,000 nyang for other expenses (King Sunjo, 1801).

As the fact that the Geojunggi was used as a transportation system was clearly and definitely recorded in the Hwaseongseongyeoguigwe, the use of the cable driving system must be inferred by relating to the cart. When considering the structural limitation of the Geojunggi of having no other choice but to pull up the stones or put down the stones, Geojunggi was probably used mainly at the quarries. It is feasible to see that the Geojunggi is not a jib crane that lifts things and puts them on the high places like the Nongno, but, is a stationary loader crane used for loading the stones on the carts.

The reason why the young government official had the power to design a new city by referring to a Chinese book on strategy and the science and technology books of the West in such a short time is because of the engineering talents that had been fostered from the time he was little. The activities of the engineer Chong Yagyong were not the voluntary things but all of them were under the command of Jeongjo. Chong Yagyong prepared a strategy for carrying through a national project by reorganizing the engineering knowledge that had been obtained by studying intensively within a short period of time according to the King's command into a systematic logic. Eventually, Jeongjo's discerning eye of looking at the gifted engineers and his leadership had made Chong Yagyong for an engineering literacy. The engineering reasoning formed while being solidified became the core capability that can compile the Silhak (Realist School of Confucianism) while writing the books in the diverse fields during the time he had been on an exile.

A convergent human resources education needs to have a wide scope that encompasses the fields of science, technology, engineering, art, and mathematics and the fields of humanities. The traditional sciences include the elements of science, technology, and engineering, and, in view of the fact that it can be approached in a cultural context based on the historical literature and records, it naturally entails the elements of the humanities.

The examples of traditional mechanical drawings introduced in this paper will complement science and technology class materials. The core principle of traditional mechanical drawing based education is to utilize the traditional sciences as a medium that connects Science, Technology and History.

The block-and-tackle mechanism is a phenomenon found simultaneously in East and West. The compound pulley and gear mechanisms documented in western 16th century literature were introduced to China in the 17th century and then studied in Korea in the 18th century. The mechanical drawing of compound pulley and gears, which reflects the history of the exchange of science and technology between the West and the East, provides support for teachers and researchers to discover and develop an effective, applicable instructional strategy.

Drawings developed by The Roman treadwheel crane and Da Vinci's crane through Wang Zheng & Joannes Terrenze Schreck's crane through Chong Yagyong's Geojunggi can be useful in science class.

REFERENCES

- Chong, H. M. (2007). Technical Illustrations of the Qiqi tushuo. *Journal of the Korean History of Science Society*, 29(1), 99-132.
- Chong, Y. Y. (1792). *Seongseo* [城說, *The City Planning in Hwaseong Fortress*]. Seoul, Korea: Institute for the Translation of Korean Classics.
- Chong, Y. Y. (1970). *Yeoyudangjeonseo* [與猶堂全書, *Collection of Tasan Chong yakyong's s works*]. Seoul, Korea: Gyeonginmunhwasa.
- Chong, Y. Y. (1983). *Tasansimunjip* [茶山詩文集, *Collection of Tasan Chong yakyong's poetry and prose*]. Seoul, Korea: Institute for the Translation of Korean Classics.
- Hideki, K. (2008). Chong Yakyong's Scholarly Works in Scientific Technology. *The Journal of Tasan Studies*, 13, 43-75.
- Kim, D. U. (2009). *New town of Choson Dynasty constructed with practical science: Suwon Hwaseong*. Paju, Korea: Dolbege Press.
- Kim, H. S. (1986). A Study on the Architectural Theory in 18th century Shillhak: Focusing on Tasan's Seongseol. *Architecture*, 30(3), 19-22.
- Kim, Y. S. (2012). The Pragmatic Character of Cheong Yagyong's Thought and Learning. *The Journal of Tasan Studies*, 21, 65-116.
- Lee, D. H. (2008). *Development of 18th century product monetary economy and construction of Hwaseong*. Seoul, Korea: Hyeon Press.
- Lee, Y. S. (2012). Tasan Chong Yagyong, Who was a Civil Engineer as Well. *KSCE Journal of Civil Engineering*, 60(7), 53-54.
- Moon, S. H. (2013). Tasan Studies, Korean Neo-Confucianism, & Curriculum Studies: Complicating Conversations in Human Nature, Knowledge, and Justice. *Journal of the American Association for the Advancement of Curriculum Studies*, 9, 1-18.
- Mun, J. Y. (2006). *Science Journey of Our History*. Seoul, Korea: East Asia Books.
- Noh, Y, K. (2007). Change in Fortification in the Late Joseon Dynasty, and Chong Yakyong's Ideas on the Model Fortification Technique. *The Journal of Tasan Studies*, 10, 133-169.
- Oh, S. H. (2007). The Geographical Thoughts of Tasan Chong Yakyong. *The Journal of Tasan Studies*, 10, 105-131.
- Son, Y. S. (2009). *Castles in Korea*, Seoul: Juryuseong.
- Song, S. S. (1994). The Technical thoughts of Tasan Chong Yagyong. *Journal of the Korean History of Science Society*, 16(2), 261-276.
- Sunjo, K. (1801). *Hwaseongseongyeoguigwe* [華城城役儀軌, *A completion report for the Construction of Hwaseong Fortress*]. Seoul, Korea: Gyujanggak.
- Sunjo, K. (1801). *Jeongjosillok* [正祖實錄, *Veritable records of King Jeongjo*]. Seoul, Korea: Gyujanggak.

Wang, Z. & Schreck, J. T. (1627). *Wonseogigidoseollokchoe* [遠西奇器圖說錄最, *Strange machines from the far West*]. Beijing, China (Qing).

APPENDIX: GLOSSARY

Cheok	尺	about 30.3cm
Jeongjo	正祖	The King Jeongjo
Chungyulyang	中遊梁	The Fixed pulley block
Eojeonghwajuryak	御製城華籌略	The City Planning that was announced by the King Jeongjo
Geojunggi	舉重機	A traditional Korean Stationary Loader Crane
Gigidoseol	奇器圖說	Strange machines from the far West. The word Gigidoseol (奇器圖說) is the abbreviation for Wonseogigidoseollokchoe(遠西奇器圖說錄最)
Gijunggadoseol	起重架圖說	Technical drawing of prototype
Hangang	漢江	Han Liver
Hayulyang	下遊梁	Movable pulley block
Hoenglyang	橫梁	Parallel Beam
Hwalcha	滑車	a sheave
Hwallyun	滑輪	The Sheave wheel
Hwaseong	華城	Hwaseong Fortress
Hwaseonggijeokbi	火城記蹟碑	A memorial stone for the Construction of Hwaseong Fortress
Hwaseongseongyeoguigwe	華城城役儀軌	A completion report for the Construction of Hwaseong Fortress
Jagyeongnu	自擊漏	Water clock
Jang	丈	about 3m
Nongno	轆轤	Jip crane
Nyang	兩	A traditional Korean monetary unit
Seongseol	城說	The City Planning in Hwaseong Fortress
Silhak	實學	Practical studies
Tasansimunjip	茶山詩文集	Collection of Tasan(pen name) Chong Yagyong's poetry and prose
Yeoyudangeonseo	與猶堂全書	Complete collection of Chong yagyong's works
Yuhyeonggeo	遊衡車	A cart that shakes like the scale

<http://www.ejmste.com>



<http://www.ejmste.com>



<https://twitter.com/ejmste>



<https://www.facebook.com/ejmste>



<http://modestum.co.uk/>



publications@modestum.co.uk



OPEN ACCESS

EURASIA Journal of Mathematics Science and Technology Education
ISSN: 1305-8223 (online) 1305-8215 (print)
2017 13(9):6165-6174
DOI: 10.12973/eurasia.2017.01056a



The Rise of MOOCs: The Literature Review of Research Progress and Hot Spots of MOOCs Education in Mainland China

Ye Zheng

School of Humanities, Economics, and Law, Northwestern Polytechnical University, CHINA

Ruo-Yu Yang

College of Management and Economics, Tianjin University, CHINA

Received 7 April 2017 • Revised 13 August 2017 • Accepted 2 September 2017

ABSTRACT

With the development of information technology, knowledge acquisition is not just limited to the traditional classroom. As a rising educational method, “Massive Open Online Courses (MOOCs)” has attracted extensive attention by educational circles. Taking 445 pieces of journal articles about educational study of MOOCs included in China Academic Journal Network Publishing database (CAJD) from 2013 to 2016 as samples, this study adopts bibliometric analysis method and visual knowledge network analysis tool CiteSpace to carry out in-depth exploration of aspects such as development status, developing trend, and hot subjects of educational study of MOOCs. The study discovers that the quantity of the articles about educational study of MOOCs presents a rising trend as a whole in the past four years. Highly cited articles mainly concentrate on pedagogy. A small part of articles focus on fields like library and information and computer science. The evolution course of study has experienced the process of “introduction-development-deepening” and its hot subjects include reflection on teaching practice, modern teaching means and existing problems and reform path. On this basis, the shortcomings of the existing researches are pointed out.

Keywords: MOOCs in education, progress and hot spot, bibliometric analysis, mapping knowledge

INTRODUCTION

With the development of information technology, knowledge acquisition is not just limited to the traditional classroom. As an educational method, Massive Open Online Courses (MOOCs) have made the educational process break through the traditional restrictions of time and space, and extend the way to acquire knowledge. In the winter of 2016, haze happened frequently in north, central and other regions of mainland China, leading to serious environmental pollution. Air pollution emergency plan was started many times in several places and primary and secondary schools therefore suspended classes. In order to ensure the smooth progress in course teaching, many teachers adopted online teaching, which aroused wide public concern of the society. Hence, “MOOCs” has become one of the most talked-about topics in the education circle. Along with the advent of the era of knowledge economy, MOOCs education will change people’s traditional learning idea and provide a new way for people to acquire knowledge more conveniently (Deng, 2013).

© **Authors.** Terms and conditions of Creative Commons Attribution 4.0 International (CC BY 4.0) apply.

Correspondence: Ye Zheng, Assistant Professor, *School of Humanities, Economics, and Law, Northwestern Polytechnical University. Address to No.127, Xianning West Rd., Beilin Dist., Xi’an City 710072, Shaanxi, China. Tel: +86-029-8326-3731.*

✉ lbxjbzy@nwpu.edu.cn yangruoyu1993abc@163.com

State of the literature

- The existing research shows that Massive Open Online Courses (MOOCs) education may be a “double-edged sword”. Although MOOCs are showing a rapid development trend and are supported by the public because of its low threshold and lack of time and space constraints, it also faces multiple doubts at the same time such as high loss of raw resources, high resource support requirements, and the system is not perfect, and so on.
- In the existing research, some scholars maintain the neutral position of MOOCs education. Their research focus on the teaching practice, education mode, means of implementation, and other aspects of MOOCs education. While approving the new educational model, it also points out that there are some problems and threats in reality. For example, the challenges in the development of MOOCs education include students’ integrity, curriculum quality, performance evaluation, innovation, and many other issues.

Contribution of this paper to the literature

- The rise of MOOCs education in mainland China is not very long. It still lacks a comprehensive comb of existing research. In this paper, we use the method of bibliometrics and visual network analysis tool CiteSpace to analyze the literature about MOOCs education published in mainland China for nearly four years, to make clear the research status, research hotspot, and evolution trend.
- This paper does not directly point out the advantages and shortcomings of MOOCs education as other scholars, but rather analyzes the research status and the shortcomings of MOOC study, as well as pointing out the development trend of future MOOCs education research from the perspective of academic research.

“MOOCs” refers to Massive Open Online Courses. It originated in the top universities of the United States and is a kind of online course development mode gradually popular in recent years in mainland China. It has such characteristics as great scale, open to the public for free, big data support and so on. Since its first introduction to China in 2013, MOOCs education has gained rapid development, and is actively changing people’s way of accepting education. According to relevant data, since “Chinese University MOOCs” was carried out in 2014, it has gradually become the first platform of MOOCs after several years of development. Now it cooperates with more than 90 colleges and universities and a total of 542 MOOCs were open to the whole nation in 2016 with more than 20 million people selecting the courses. Currently, the learning concept of MOOCs have been incorporated in the mind of the general public imperceptibly and the learning mode of MOOCs have been gradually spread from universities to primary and secondary schools in Shanghai, Guangzhou and other developed areas in mainland China.

Existing research shows that MOOCs education may be the “double-edged sword”. Although MOOCs have been supported and favored by all sectors of society due to their low threshold and being not limited by the space and time and now it shows a trend of rapid development, it is still questioned by most academic circles because of its own high loss of students, high resource support requirements and imperfect system. Some scholars stay neutral for MOOCs education. They conduct studies on MOOCs education respectively from teaching practice, educational mode, implementation means, etc. In recognition of MOOCs education mode, they also point out that it still has problems and threats in reality. For example, some scholars put forward that MOOCs have not been endorsed by many educators at present and are disruptive, resulting in potential threats to the higher education mode (Haggard et al., 2014). Some scholars summed up the challenges in the development of MOOCs, including 10 problems such as students’ integrity, curriculum quality, performance evaluation and innovativeness (Gao, 2015).

In short, MOOC has been the subject of heated discussion in the academic world since it was introduced into mainland China. Scholars have revealed the practice development status from different theoretical perspectives. However, the following issues should be handled clearly in a timely manner: What is the current research status of MOOCs education? How is its evolution process? What research hotspots does it include? When will MOOCs education develop into full swing? In view of this, taking 445 pieces of core journal articles about educational study of MOOCs included in CAJD database in mainland China from 2013 to 2016 as samples, this study adopts bibliometric analysis method to carry out in-depth exploration of aspects such as quantity of articles

about the MOOCs education research and highly cited literature information. On this basis, it also takes advantage of Citespace5.1 to draw co-word network atlas based on key words and depict the development status and hot subjects of educational study of MOOCs. Finally, based on the analysis and arrangement of the existing research literature, this paper points out deficiencies of the research on MOOCs education and clearly presents future research directions. This study aims at providing important reference for the current and future MOOCs education from the perspective of theoretical research development in depth and breadth, and practice advancement.

RESEARCH DESIGN

This paper takes the journal literature of MOOCs education research as the research object, and data come from the journal paper library of the mainland China Academic Journal Network Publishing Database (CAJD). The document retrieval was conducted on January 14, 2017 with "MOOCs" and "education" as the themes and logical relationship was selected to be "contain". The retrieval years were from 2013 to 2016. In order to guarantee the quality of research papers, "Chinese Social Science Citation Index (CSSCI)" was chosen for the journal source category. After invalid documents such as meetings and circulars were deleted, 445 valid pieces of papers were eventually obtained, including 649 authors and 1234 quotations with pedagogy, computer science and other research fields involved. These journal articles are the main knowledge results of the present MOOCs education research. They can reflect the present situation of the research and are the foundation of the hotspot mining.

In this paper, the research method is Bibliometric Analysis, which uses qualitative research methods such as statistics, regards the literature system and bibliometric characteristic as the research objects, and explores knowledge structure, characteristics and laws in some field of study by analyzing the distribution features, quantitative relation and evolution rules of the research literature. Specifically, this paper makes statistical summary of the quantity of research papers, highly cited documents, and then describes the research status and adopts co-word analysis based on keywords for the evolutionary process analysis and hot topic mining. Co-word analysis, as one of the analysis methods of bibliometrics, explores the evolution trend and hot topics in the field of study by counting the frequency of two keywords of literature in the same stage and according to the relations of common key words after clustering integration. To show the research status clearly and artistically and to achieve the visualization effect, this paper adopts the visual knowledge atlas analysis instrument CiteSpace5.1, which has the function of co-word analysis based on keywords and can draw clustering atlas and time zone atlas to explore the research status and hot spots in some field of study.

RESEARCH STATUS AND ANALYSIS OF EVOLUTIONAL CHARACTERISTICS

Figure 1 depicts the annual quantity of papers published and the overall trend of mainland China's MOOCs education research since 2013. In general, the quantity of MOOCs education research literature presents a fast growth tendency. Since MOOCs formally entered mainland China in 2013, a few scholars have begun to pay close attention to MOOCs education. Thus, the number of related research increased dramatically in 2014 and 2015, and rose to 160 articles in 2015 from 5 in 2013, showing scholars strong research interest in MOOCs education. Although research publications of MOOCs education fell slightly in 2016, the quantity still remains high as a whole. With the gradually rising cognition and acceptance of the current educational world and the social public for MOOCs education, education research literature of MOOCs also presents the trend of "developing from nothing" in number, which further reflects the academic circle's earnest attention to the hot spot phenomenon in educational practice. In accordance with the forecast of CAJD database, research articles of MOOCs education will be up to about 250 in 2017. The quantity of related research literature continues to present a trend of rapid growth, which is also a positive response of the academic world to the rapid popularization of the current MOOCs educational practice. In addition, in order to compare the coupling relationship of "MOOCs education research" and "MOOCs research", this study specially counts the quantity of core periodical publications with "MOOCs" as the theme according to the same literature retrieval method. Thus, it can be further seen that two research topics completely overlapped in 2013, but papers of MOOCs education research began to be fewer than those of MOOCs research since 2014. In 2015 and 2016, the gap of article quantities grew and showed the consistently changing characteristic, namely, tending to be gentle for the quantities of articles, which indicates that "MOOCs education research" is an

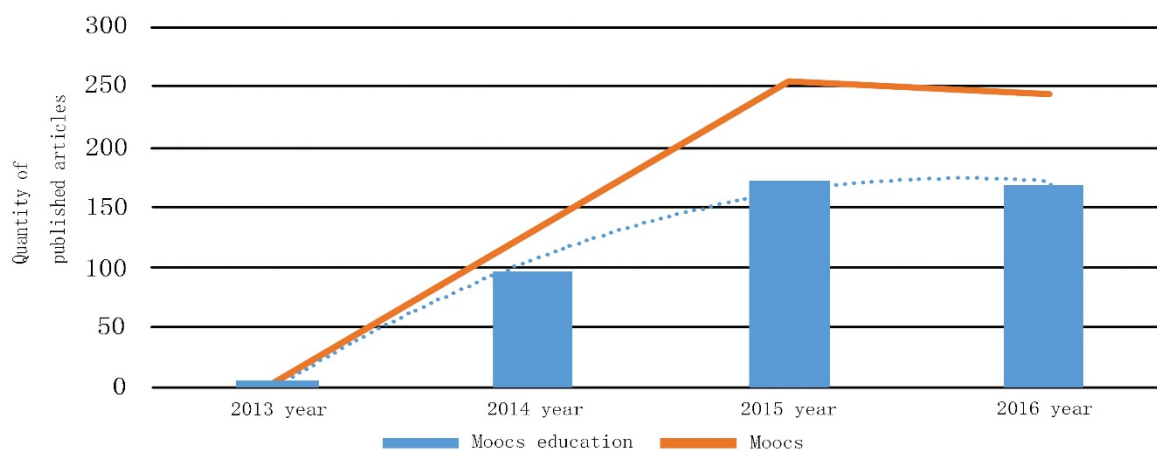

Figure 1. Quantities of Articles about MOOCs Research and MOOCs Education Research in mainland China (2013-2016)

important part of “MOOCs research” and the research topic of MOOCs education is the mainstream research direction of the MOOCs research.

Seen from the bibliometrics, research literature cited most frequently in some field of study is usually the concentrated reflection of research hotspots in this field. **Table 1** shows 15 papers with top frequency of citation among MOOCs education research papers in mainland China since 2013.

From the year distribution, highly cited literature of MOOCs education is mainly concentrated in 2014 when MOOCs education was just introduced into mainland China and many scholars conducted introductory or exploratory research on it or made some experience summary and reflection based on foreign practical experience, showing scholars’ attention and response to realistic practice. In terms of periodical distribution, due to low quality and influence of periodicals, only about half of the periodicals are included by CSSCI and the impact factor of most of periodicals is lower than 1.00, which can partly reflect the low quality of the current MOOCs education research papers, and there is greater room for improvement. In addition, highly cited articles of MOOCs education research are mainly concentrated in pedagogy field and also involve library information, computer science and other fields. From the research content, highly cited literature mainly introduce the basic concepts and practice situation of MOOCs education from the experience reference and practical reflection, and illustrate scholars’ observation and reflection of subject contents related to MOOCs education, such as Zhang (2014), Qin (2014), Wu (2014), etc. However, among the research literature, all authors adopt the normative research method except Jiang et al. (2015). There is scarce empirical research and there is lack of contribution in the construction of a theoretical system for the research content.

Taking advantage of the Time Zone provided by Citesapce5.1, this paper describes the evolutionary situations of high-frequency keywords in each year. The correlation between high-frequency keywords can reflect the evolution process of MOOCs education research and the results are shown in **Figure 2**. Since 2013, hot frontier information of MOOCs education research in mainland China includes more than 20 keywords, such as Mooc, information technology, learning process, online education, flipped classroom, teaching reform, teaching mode, and so on.

Table 1. Highly Cited Literature (Top 15) of MOOCs Education Research

Ranking	Author	Title	Journal	Year	Frequency of Being Cited
1	Zhang, Z. Y.	The MOOCs and Chinese Higher Education	Journal of Hebei Normal University (Educational Science Edition)	2014	245
2	Qin, H.	Rising Tide of MOOCs and Roles of Libraries	Journal of Library Science in China	2014	150
3	Wu, W. W.	Sober Reflections about MOOCs Mania	Fudan Education Forum	2014	149
4	Ye, Y. M.	MOOCs: A Fulcrum to Lever the New Reform of the Library	Journal of the National Library of China	2014	119
5	Haggard, S., et al.	The MOOC Is Maturing	Educational Research	2014	104
6	Hu, H. & Liu, Y.	Thoughts on Higher Vocational Colleges' English Education in MOOC Era	Vocational and Technical Education	2014	85
7	Sang, X. M., et al.	Deep Interpretation of Effect of MOOC Tide on Universities and Future Prospects	China Higher Education	2014	82
8	Dong, L. L.	Impact of MOOC on Traditional Higher Education and Countermeasures	China Adult Education	2013	72
9	Chen, Y. K.	Research on MOOC of Primary and Secondary Schools and Flipped Classroom Teaching Mode	Curriculum, Teaching Material and Method	2014	68
10	Pan, Y. T. & Liao, Y. Y.	MOOC Trend of University Students' Information Quality Education	Journal of Academic Libraries	2014	65
11	Jiang, M. W., & Li, X. Z.	Thinking of MOOC Mania	Journal of Hebei Normal University (Educational Science Edition)	2014	62
12	Wu, W. Z., et al.	Thoughts on University Teaching Reform Triggered by MOOC Tide	Journal of Northeast Normal University (Philosophy and Social Sciences)	2015	55
13	Jiang, Z. X., et al.	Learning Behavior Analysis and Prediction Based on MOOC Data	Journal of Computer Research and Development	2015	53
14	Hao, D.	MOOC: Subversion and Innovation? Review of the Fourth Young Scholars Forum of China Distance Education	Distance Education in China	2013	53
15	Gao, D.	MOOC: Core Ideology, Practice Reflection and Cultural Security	Journal of Northeast Normal University (Philosophy and Social Sciences)	2014	51

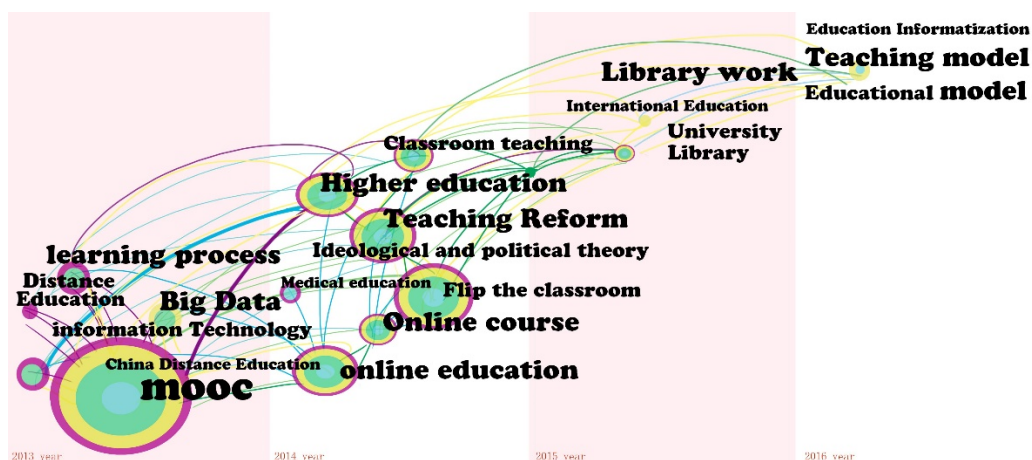

Figure 2. Knowledge Atlas of the Evolution Process of MOOCs Education Research Topics (2013-2016)

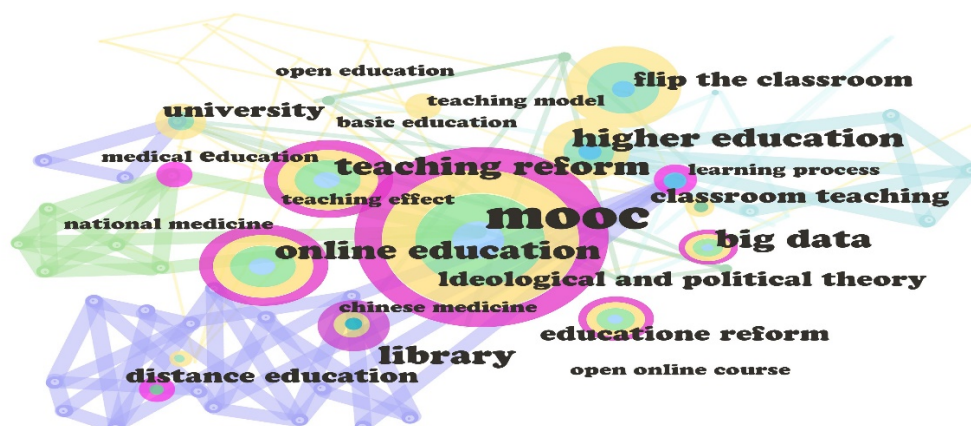

Figure 3. Co-word Network Atlas of MOOCs Education Research (2013-2016)

Combined with the articles published and time distribution features of keywords, it can be concluded that MOOCs education has roughly evolved from “domestic introduction” to “rapid development” and then to “content deepening”. Specifically, (1) In 2013 when MOOCs education was just introduced into mainland China, a few scholars had a strong interest in it and took the lead to study the related subjects. In this stage, the main keywords included MOOC, learning process, information technology, etc. The research was dominated by experience introduction and exploration of the impact effect. When focusing on the importance of MOOCs education, it also pointed out that educators should tackle the effects brought by MOOCs education positively and practically. In addition, it also offered positive referential significance to the subsequent research. During this period, some basic contents had been put forward for the field of study early. (2) In 2014, MOOCs education research achieved rapid development. Its research field was extended and the research depth was also enhanced. Keywords in the research subject included flipped classroom, teaching reform, higher education, online education, etc. Due to the background of MOOCs as “an imported teaching mode”, scholars in mainland China had been aware of the need to combine the current development of information technology with subject characteristics to absorb and accept MOOCs education according to local conditions. On this basis, studies in this phase not only attached importance to the exploration of MOOCs education’s value and importance, but paid more attention to the role and feasibility of MOOCs education practice, which also strengthened the depth and breadth of the research to a certain extent. Moreover, absorption and popularization of MOOCs education practice were proposed gradually in specific subject fields such as medical education and ideological and political education, which also reflected the feature of MOOCs education research “coming from practice and guiding practice”. (3) In 2015 and 2016, research basically followed the research contents of the first two years. However, research in 2015 paid more attention to the thinking of means and ways by which MOOCs education could be implemented and emphasized the role of university library in the construction and promotion of MOOCs education. The research in 2016 attached greater importance to the effect and role of MOOCs education on and in the teaching mode, and summarized the existing research results. However, on the whole, there was no breakthrough compared with the previous research.

DISCUSSION OF MOOCs EDUCATION RESEARCH HOTSPOTS AND THEMES

Based on co-word analysis of keywords in the periodical literature, co-word network knowledge atlas of keywords of MOOCs education research can be generated through Citesapce5.1, as shown in **Figure 3**. In the co-word network atlas, the frequency of key words determines the size of node circle. Thickness of node connection reflects the correlation between the nodes, and the size of nodal label font is determined by the frequency and centrality of nodes. Seen from the overall structure of co-word network atlas, nodes with greater influence attracted other nodes. These nodes also interacted with each other, generating homogeneous attraction. Naturally, several hotspot themes could be condensed and formed. As shown in **Figure 3**, MOOCs was the most influential and the core of the network. Words like “flipped classroom”, “teaching form”, “online education” and “online classroom” had greater influence, reflecting the hot subjects of MOOCs education research.

Table 2. List of Top 30 High-frequency Keywords of Research on Disclosure of Government Information

Ranking	Keywords	Frequency	Ranking	Keywords	Frequency	Ranking	Keywords	Frequency
1	MOOC	313	11	Ideological and Political Theory Course	11	21	Medical Education	8
2	Flipped Classroom	33	12	Colleges and Universities	10	22	Distance Education	8
3	Online Education	29	13	Countermeasure	9	23	Basic Education	7
4	Teaching Reform	29	14	Massive Open Online Course	8	24	Educational Reform	7
5	Higher Education	27	15	Big Data	8	25	Open Education	7
6	Online Course	18	16	University Library	8	26	Education	6
7	Teaching Mode	16	17	Teaching Effect	8	27	Educational Reform	6
8	Information Technology	16	18	Challenge	8	28	Ideological and Political Education	6
9	Classroom Teaching	14	19	Library	8	29	Thinking	6
10	Learning Process	13	20	Micro-course	8	30	Localization	5

Word frequency analysis software was further adopted to make word frequency statistics of keywords for the research papers retrieved. The result shows that 445 papers of MOOCs education research contain 898 effective keywords and the total frequency of the keywords is 2240, which means there are 2.02 keywords in each paper on average. **Table 2** shows the top 30 keywords of high frequency according to the summary of software analysis results. These keywords are important research contents in the current study field of MOOCs education and also reflect the research hotspots in the field to some extent. Among these key words, the frequency of MOOC is up to above 300, so MOOC is the core of the research field. In addition, “flipped classroom”, “online education” and “teaching reform” also appear relatively frequently, which can also reflect that they are hotspots of the MOOCs education research. Combining with the high-frequency keywords of MOOCs education research and the content of the classical literature, hot topics of MOOCs education research in recent years include: reflection on teaching practice, modern teaching method, and reform of educational mode.

The first aspect is about the research on the reflection of teaching practice. As disruptive innovation, MOOCs education had huge impact in the education innovation when it first appeared and many scholars launched a series of studies on the topic. High-frequency keywords included in the research hotspot are flipped classroom (33), higher education (27), classroom teaching (14), learning process (13), medical education (8), ideological and political theory (6), teaching effect (8), etc. MOOCs education, as a new way of online education, has triggered a heated discussion among all sectors of society since it was introduced into mainland China in 2013. Due to the application of modern information technology, MOOCs education has realized “home schooling” and broken through the requirements of traditional teaching methods for time and space. It is a kind of innovation of educational practice. Some scholars point out that MOOCs education has thoroughly changed the relationship between teachers and students in the traditional teaching, and knowledge teaching begins to change from the dominated “teachers teaching” to “students selecting”, reflecting essentially the change of supply and demand relation in terms of knowledge acquisition. MOOCs originated from foreign countries, so there is a certain gap between its background of emergence and reality. Therefore, MOOCs education is a little unaccustomed to in mainland China, and would also generate some unknown threats like educational crisis and culture invasion, which scholars have also discussed.

The second one is about the research on modern teaching means. As a new type of education, MOOCs education needs some tools to be relied on. Therefore, the research on modern teaching means also has become an

important component in the field of MOOCs education research. High-frequency keywords contained in the topic include online education (29), online courses (18), information technology (18), massive open online courses (8), big data (8), university library (8), library (8), micro-course (8), etc. Compared to traditional education, the more obvious difference of MOOCs education lies in the teaching means and tools it relies on. The concept of MOOC generated in big data. Due to the development and progress of big data technologies, MOOC was gradually made a reality from the concept. Therefore, the reason why MOOCs education can be realized is fundamentally beneficial from the modern teaching means brought by the advances in information technology. MOOCs education needs no campus and facilities that are necessary for the traditional education, but it needs to be established on the construction of digital teaching resources and teaching platforms. Scholars have also realized the particularity of MOOCs education, so they have discussed modern teaching means by which MOOCs education could be achieved. At present, most of scholars believe that, university libraries should be the platforms and major construction forces for MOOCs education. By virtue of huge education teaching resources and information technology advantages, combined with the special status in knowledge production, storage, and innovation process, they can effectively boost the construction and promotion of MOOCs education.

The third one is about the research on the existing predicament and pathways of transformation. High-frequency keywords contained in this research hotspot include teaching reform (29), teaching mode (16), countermeasures (9), challenges (8), basic education (7), educational reform (7), open education (7), educational transformation (6), localization (5), etc. With the advancement of MOOCs education practice, MOOCs education research has also ushered in deepening development in mainland China. This research hotspot reflects that a large number of scholars put forward that MOOCs education mode may have some problems, and propose practical and effective countermeasures and suggestions when they think profoundly about the present situation and dependence means of MOOCs education. For instance, some scholars hold that in the development of MOOCs education, there are such problems as the falling participative enthusiasm of universities, teachers and students, imperfect ecological system that supports open online education mode, and universities' lack of power to conduct MOOCs education. They also suggest that mainland China should ensure the supply of effective systems and policies, and universities should provide necessary support and services for the development of MOOCs education. Teachers should strive to promote information literacy, professional competence and teaching level. There are also some scholars who criticize the traditional education mode under the current background of MOOCs education, and put forward that universities should have innovative information teaching methods, establish MOOCs credit recognition method. They also propose specific measures for the reform of teaching practice in the evolutionary process from the traditional education mode to MOOCs education mode.

In short, from the co-word network atlas based on keywords (Figure 3) and statistical results of high-frequency keywords (Figure 2), it can be summarized that the current hotspots of MOOCs education research are as mentioned above. The coupling relationship between keywords in the co-word network of MOOCs education research is very complicated and the staggered distribution between keywords of hotspots reflects that the current research hot subjects are not independent, but have intrinsic links. The interrelation and support between research subjects jointly promote the development and evolution of MOOCs education research in mainland China.

CONCLUSION AND FUTURE PROSPECTS

Through the in-depth analysis and review of journal papers of MOOCs education research in nearly four years, based on the understanding of time-space distribution of research literature, this paper discusses highly cited literature, evolutionary trend and hot contents. Specifically, the main conclusions of this paper include: (1) mainland China's MOOCs education research presents an overall increasing trend, and now it is in the rapid growth; (2) highly cited articles of MOOCs education research are mainly concentrated in pedagogy field and part of the literature also involves library information, computer science and other fields. Most of the research adopts the normative research method and there are fewer empirical research results. In the meantime, the research content also lacks the contribution to the construction of a theoretic system; (3) the evolution of MOOCs education research reflects the progressive process "introducing-developing-deepening"; (4) high-frequency keywords include flipped classroom, online education, teaching reform, teaching mode, information technology, etc., and the research

hotspots are reflection on teaching practice, research on modern teaching means, and research on existing problems and pathways to transformation.

Although the current MOOCs education research presents the good development momentum, positively responds to the practical development of MOOC technology and forms effective guidance to the traditional educational practice, on the whole the research has the following deficiencies: First, research content is relatively scattered with insufficient construction of a theoretical system. Although most of the MOOCs education research focuses on the education science, research objects are relatively complicated. Such contents as teaching mode, learning process and platform construction are involved in existing research, but at present there has not been an effective theoretical framework to integrate the research contents and form a set of scientific theoretical system. Second, the research is quite shallow and research depth is excavated limitedly. Since MOOC appeared first in mainland China in 2013, MOOCs education research has only been developed for 4 years. In the relatively short period, scholars' research is still in the exploratory stage. Descriptive and dialectical research is still the mainstream, and countermeasures and suggestions proposed based on this are also vacuous and general. Therefore, there is great space for the improvement of the practical guidance. Third, the research method is simplex and quantitative research needs to be strengthened. Current research mainly describes the reality and elucidates views, so scholars regard the observation and thinking of MOOCs education practice as the primary research contents. Research methods adopted are mostly normative. Only a few studies use the quantitative empirical research method so that the research as a whole lacks objective data and related empirical evidence to support.

Given the deficiencies of the existing research, based on the development trend of MOOCs education practice, related research in the future can be strengthened in the following aspects: First, it can integrate existing research results and explore a theoretical system. Although MOOCs education embraces shorter development and its practice and research are still in the rapid growth, it still has made a certain amount of achievements. Therefore, effective integration of these research results should be conducted in the future research and further research can be carried out to ravel out the logical relations of concepts and variables, and explore to form a set of reasonable theoretical system to lay an important foundation for the future MOOCs education research. Second, scholars should enhance exchanges and cooperation, and strengthen the research depth. At present, the research content of MOOCs education is scattered, which means that scholars of different backgrounds conduct their research from their own disciplines. Research forces are distributed and independent, but longitudinal and deep advancement of MOOCs education research needs joint efforts of multiple forces. Therefore, in future research, scholars in different disciplinary systems should cooperate with each other and promote the further deepening of research through complementary advantages and resources integration. Finally, quantitative research should be introduced to enrich the research methods. In the latest research of MOOCs education, there have been some studies that use quantitative research methods such as questionnaire survey, data analysis and so on. In future research, quantitative empirical research methods should be more generalized to strengthen objective data support of MOOCs education research and form close integration of qualitative and quantitative research combined with existing normative research methods.

REFERENCES

- Bu, C. L., & Kong, S. Z. (2016). Current Situation and Reflection: Review of Domestic Flipped Classroom Research. *Distance Education in China*, (2), 26-33.
- Chen, C., Ibekwe-SanJuan, F., & Hou, J. (2010). The Structure and Dynamics of Co-citation Clusters: A Multiple-perspective Co-citation Analysis. *Journal of the American Society for Information Science and Technology*, 61(7), 1386-1409.
- Chen, Y. K. (2014). Research on MOOC of Primary and Secondary Schools and Flipped Classroom Teaching Mode. *Curriculum. Teaching Material and Method*, (10), 10-17+33.
- Chen, Y., Chen, C. M., Luan, C., & Wang, X. (2015). The methodology function of CiteSpace mapping knowledge domains. *Studies in Science of Science*, (2), 242-253.

- Deng, H. Z., Li, M. J., Chi, Y., & Tan, S. (2013). Discussion of the Problems in MOOC Development. *Science and Technology Innovation Herald*, (19), 212-213+215.
- Dong, L. L. (2013). Impact of MOOC on Traditional Higher Education and Countermeasures. *China Adult Education*, (23), 145-146.
- Gao, D. (2015). MOOC: A New Challenge for University Ideological and Political Education. *Leading Journal of Ideological and Theoretical Education*, (3), 104-108.
- Haggard, S., Wang, B. H., & He, X. L. (2014). The MOOC Is Maturing. *Educational Research*, (5), 92-99+112.
- Huo, H., & Liu, Y. (2014). Thoughts on Higher Vocational Colleges' English Education in MOOC Era. *Vocational and Technical Education*, (8), 43-45.
- Jiang, Z. X., Zhang, Y., & Li, X. M. (2015). Learning Behavior Analysis and Prediction Based on MOOC Data. *Journal of Computer Research and Development*, (3), 614-628.
- Li, L. (2014). Logical Perspective of Ideological and Political Course Reform under the Background of MOOC. *China Higher Education*, (2), 37-39.
- Qin, H. (2014). Rising Tide of MOOCs and Roles of Libraries. *Journal of Library Science in China*, (2), 19-26.
- Qin, K. (2015). MOOC Copyright and Library-The Library Provides the Fulcrum, Difficulty and Breakthrough Point to Copyright Services. *Library*, (4), 11-14.
- Qu, L. Y. (2000). Lifelong Learning Is the Survival of the Knowledge Economy Era. *Journal of Hunan Agricultural University (Social Sciences)*, (1), 47-49.
- Ren, S. H., & Hu, L. Z. (2014). Challenges and Strategies for Academic Libraries in the Environment of Emerging Technologies. *Journal of Academic Libraries*, (1), 14-19.
- Su, X. (2013). MOOC Is Coming. *Distance Education in China*, (7), 1.
- Wang, Y. J., Feng, C., & Nie, Y. J. (2015). Situation Analysis of MOOC in China Higher Education and Countermeasure. *China Educational Technology*, (6), 80-85.
- Wei, Z. M. (2015). The Problems and Countermeasures of MOOC Localization Development. *Journal of Northwest Normal University (Social Sciences)*, (1), 78-84.
- Wu, F. B. (2015). Exploration of Teaching Reform in Higher Vocational Colleges under the Background of MOOC. *Education and Vocation*, (3), 44-45.
- Wu, R. M., & Kong, Y. F. (2010). A Comparison on Co-word Analysis and Co-citation Analysis. *Information and Documentation Services*, (1), 25-27.
- Wu, W. W. (2014). Sober Reflections about MOOC Mania. *Fudan Education Forum*, (1), 10-17.
- Yin, D. (2015). Essence Interpretation, Reality Reflection and Future Prospects of MOOC. *E-education Research*, (5), 59-63.
- Zhang, J. M. (2016). A Critical Analysis of MOOCs from the Perspective of Higher Educational Modernization. *E-education Research*, (3), 66-71.
- Zhang, Z. Y. (2014). The MOOCs and Chinese Higher Education. *Journal of Hebei Normal University (Educational Science Edition)*, (2), 116-121.
- Zheng, Y. (2014). Mapping Knowledge Domains of Foreign Innovation Driven Research Based on Citation Analysis. *Science and Technology Management Research*, (21), 7-13.
- Zhu, Q. F. (2014). Dilemma of Chinese Higher Education MOOC Development and Rational Approaches. *Research in Education Development*, (23), 73-77.



The Effect of Preschool Mathematics Education in Development of Geometry Concepts in Children

Sanja M. Maričić

University of Kragujevac, Teaching Training Faculty in Užice, SERBIA

Jelena D. Stamatović

University of Kragujevac, Teaching Training Faculty in Užice, SERBIA

Received 19 May 2017 • Revised 15 July 2017 • Accepted 24 August 2017

ABSTRACT

Given the fact that early mathematics education is important for further learning of mathematics, authors of this paper examine the effects that preschool mathematics education on development of geometry concepts in children. On a sample of 290 children, through a one-on-one interview, we studied the development of geometry concepts in children at the end of preschool education in Serbia. Research results show that the preschool mathematics education achieves significant effects developing geometry concepts in children. Preschool mathematics education does not achieve equal effects on the development of all geometry concepts covered by the curriculum of preschool education, that there are no differences in the development of these concepts depending on the location of the preparatory preschool institution and the gender of the child, but that the education level of the child's parents has great impact on the development of these concepts.

Keywords: geometry concepts, mathematics, preschool mathematics education, preschool child

INTRODUCTION

In recent years, there has been a number of initiatives that emphasize the importance of preschool mathematics education. One initiative is especially important in this field, and that is the initiative from 2000 in which the *National Council of Teachers of Mathematics* (NCTM), while revising the standard for primary and secondary education from 1989, included the standard for preschool education for the first time. This initiative generated the common position of the *National Association for the Education of Young Children* (NAEYC) and the *National Council of Teachers of Mathematics* (NCTM) that "high quality, challenging, and accessible mathematics education for 3- to 6-year old children is a vital foundation for future mathematics learning" (2002: 1). The importance of these initiatives is confirmed by numerous documents and papers that promote preschool mathematics education and indicate that it should be more intensive and organized in this age (OECD, 2001; Penn, 2002; Dahlberg & Moss, 2005), because "the foundation for children's mathematical development is established in the early years" (Seefeldt & Wasik, 2006: 249) and basis for the later success in mathematics (Bodovski & Farkas, 2007; Denton & West, 2002; Jordan et al., 2009).

© **Authors.** Terms and conditions of Creative Commons Attribution 4.0 International (CC BY 4.0) apply.

Correspondence: Sanja M. Maričić, *University of Kragujevac, Teaching Training Faculty in Užice, Serbia, St. Save Square 36, 31000 Užice, Serbia.*

✉ sanjamaricic10@gmail.com

State of the literature

- The foundation for children's mathematical development is established in the early years and basis for the later success in mathematics.
- Geometry teaching is more important in preschool period, when first critical geometrical observations are made, when instincts are developed, and concept and information are acquired, than in the other periods following it.
- Children form concepts of shapes even before they start school and that geometric concepts in children, although limited, are stabilized by the age of six.

Contribution of this paper to the literature

- The aim of this paper is to determine the role of preschool mathematics education in the development of geometric concepts in children.
- The research has shown that preschool mathematics education achieves significant effects developing geometry concepts in children, but does not achieve equal effects on the development of all geometry concepts.
- The research has shown that children have more success in identifying and naming geometric shapes on objects in their environment, than when they observe these same shapes as geometric images devoid of materiality.

When it comes to preschool mathematics education, two areas of mathematics have proven essential for this kind of education "1) numbers, operations and relations among them and 2) geometry, spatial thinking and measurement" (Cross, Woods, & Schweingruber, 2009: 2).

BACKGROUND OF THE STUDY

Various authors point out the importance of geometry in children's development. Dutch mathematician H. Freudenthal highlights: „Geometry is grasping space. And since it is about the education of children, it is grasping that space in which the child lives, breathes, and moves”(1973: 403). Results of some studies show that spatial thinking is an important prerequisite of mathematics achievement, and that it has impact on verbal and mathematics skills (Clements & Sarama, 2007; Stewart, Leeson, & Wright, 1997; Wheatley, 1990). The importance of geometric contents is also being contemplated in the context of the development of logical and mathematical thinking (Ćebić, 2006: 15; Prentović, 1998: 271; Dobrić, 1979: 121). Recognizing this fact, N. M. Beskin points out that no other school subject puts logical and mathematical thinking to the fore as much as geometry does, or, “that no other school subject possesses such possibilities for developing logical thinking as geometry does” (1948: 19).

Geometry teaching is more important in preschool period, when first critical geometrical observations are made, when instincts are developed, and concept and information are acquired, than in the other periods following it (Develi & Orbay, 2003; Kesicioğlu, 2013: 48). Despite the importance of geometric contents, and the fact that geometric objects in the form of models exist in the child's surroundings as different objects and phenomena, that the child is in the situation to manipulate their models on daily basis, observe them, and use them in games, geometric concepts are abstract and complex to adopt. For these reasons, planning and organizing activities aimed at children's adoption of geometric concepts is a challenging task for teachers. To achieve this task, one must be acquainted with psychological, pedagogical and methodological foundations of the development of these concepts. On the other hand “despite the growing attention given to the geometry skills in early grades, still numbers and operations are the first content areas to which children are usually introduced” (Yeşil Dağlı & Halat, 2016: 190).

Development of geometric concepts, in the opinion of J. Piaget and B. Inhelder (1967), occurs in developmental sequences, in which children first start to distinguish between objects based on the topological characteristics, and only later based on Euclid's axioms. A child of this age can adopt facts, recognize names and name shapes, but he/she is not capable of comprehending relations and connections between shapes, nor is he/she capable of deeper understanding of the very essence of geometric concepts. Also, the child's reasoning is global, undifferentiated, so the child identifies geometric shapes with objects of the same properties. A methodological

procedure for developing geometric concepts in preschool children is based on these findings, according to which children “are first introduced to 3D shapes, and then to geometric figures as parts of these 3D shapes” (Dejić, 2003: 84). This stage in the development of geometric concepts is the opposite to the system of Euclidian geometry, that is, axiomatic geometry where one starts from basic concepts and axioms, and it is also determined by the fact that children of this age are not capable of thinking and reasoning at the formal deductive level.

Developing geometrical reasoning, progressing from visual to descriptive and analytical reasoning may go hand in hand with developing the ability to form well-defined concepts in other domains as well (Levenson et al., 2011: vii). According to Van Hiele (1986), geometric concepts are developed through hierarchically organized levels. The first level of the Van Hiele’s theory is identified as the visual level. Main characteristic of this level is that a child gets acquainted with shapes through practical activities, observes them as a whole and does not make a difference between the parts that make up the whole. A child at this level is able to name the shape, but he/she cannot give any explanation for such naming, which is why this level marks the level of nonverbal thinking. At the second level, which Van Hiele labels as the descriptive level, the child is able to identify and describe relations and properties of certain shapes, but that knowledge is not logically organized, because children cannot recognize essential links between objects. At the third level, which is marked as the level of informal deduction, children express observed relations through words and begin to use mathematical language. Van Hiele (1986) points out that preschool children are not able to reach the level of formal logic and the level on which they could comprehend the laws of logic.

A successful development of geometric concepts in children indicates the regard for the level of development of the child’s mental structures and finding the most efficient way for their development. According to Van Hiele’s theory, geometrical reasoning levels can be improved if individual is supported by education (Van Hiele, 1986). The research reviewed to this point suggests that development of geometric knowledge is fueled by experience and education, not just maturity (Cross et al., 2009: 192). Also, we have to consider the fact that no geometric concept can be fully formed at this age, and that it cannot be built through a single activity. The process of developing these concepts should be integrated into overall development of the child, and into acquisition of knowledge in other subject areas. The most important thing in developing geometric concepts is to put the child in the position to observe objects of different shapes as often as possible, because only on the basis of sensory experience can the child transform perceptions into concepts, and ultimately express those concepts through words and images.

The results of research studies show that children form concepts of shapes even before they start school (Clements, 2001; Clements & Sarama, 2000a), and that geometric concepts in children, although limited, are stabilized by the age of six (Clements & Sarama, 2000b). Many mathematics education studies “have focused on number sense and counting skills of children in the elementary grades at the youngest and been conducted in western countries, leaving a gap about younger children’s conceptual understanding of geometric shapes in different cultural settings” (Yeşil Dağlı & Halat, 2016: 190).

For these reasons, we have chosen to examine the development of geometric concepts in children in our study, and thus to determine the effects of preschool mathematics education on their development. In addition to the importance of developing geometric concepts for the overall mental development of the child, development of thinking, abstraction and reasoning, their significance is also reflected later in the process of education, because established concepts represent a basis for further learning. The main objective of this research was to determine the development of geometric concepts in children at the beginning of their education, in order to comprehend the role of preschool mathematics education in that process.

Educational Context

Preschool education in Serbia is organized within preschool institutions, with children aged 3 to 6.5 and is not compulsory for all children. Namely, the General Bases of the Preschool Curriculum in the Republic of Serbia are divided into three units: 1) *Bases of the Curriculum Aimed At Children Aged 6 Months to 3 Years*, 2) *Bases of the*

Curriculum Aimed At Children from the Age of 3 to Their Introduction into the School Preparatory Program and 3) Preparatory Preschool Program (Guidelines on the Basis of Preschool Curriculum, 2006: 1). Mathematics education becomes an integral part of activities with children in the Curriculum Aimed at Children from the Age of 3 to Their Introduction into the School Preparatory Program and lasts three years, but this program is not compulsory for all children. The law states that all children have to attend the Preparatory Preschool Program which lasts one year (Law on Primary Education, 2014). This program is organized in preschool institutions for all children who previously attended the Curriculum Aimed at Children from the Age of 3 to Their Introduction into the School Preparatory Program, whereas the program is organized within special classes in primary schools for children who didn't attend it. Both groups of children are in charge of preschool teachers who follow a unique program prescribed by the government (Guidelines on the Basis of Preschool Curriculum, 2006). Program content comprises the following thematic units: Observing and understanding the concept of space and spatial relations; Forming the concept of a set; Forming the concept of numbers (counting, forming the concepts of numbers up to 10, number sequence, position of the number in a number sequence); Developing the concept of plane shapes (circle, square, triangle, rectangle) and solid shapes (ball, cube, cuboid, cylinder); Measurements and units of measure (length, mass, volume, time) (Guidelines on the Basis of Preschool Curriculum, 2006: 127). Children who attend the preschool education program in preschool institutions from the age of three are introduced to and acquire logical and mathematical knowledge and adopt the aforementioned mathematical contents by age groups. Those who attend the Preparatory Preschool Program within special classes in primary schools were not able to acquire this knowledge in an organized way before, so they begin to adopt it now. For these reasons, we wanted to determine whether there are differences in the development level of geometry concepts with regard to the place where children attended and completed the preschool mathematics education program, because children who attended preschool institutions had the opportunity to adopt these contents during a three-year period, whereas children who started the program one year before primary school had significantly less time to do the same.

RESEARCH METHODOLOGY

Participants

The study sample was chosen from the population of preschool children from the Republic of Serbia and it consisted of 290 children (boys 141, girls 149, $M_{age} = 5.6$ years, age range: five to six years). The study sample consisted of children from socially homogenous middle-class population. The structure of the sample is presented in Table 1. Of the total number of children, 198 mastered the preschool curriculum in preparatory preschool institutions, and 92 children were encompassed by preschool mathematics education only for a year, as parts of special groups within their primary schools.

Table 1. Structure sample

Children	Gender		Place of preparatory preschool program		Fathers' level of education		Mother' level of education	
	Boys	Girls	Preschool institution	Primary school	primary/secondary school	college/university	primary/secondary school	college/university
f	141	149	198	92	204	86	195	95
%	48.6	51.4	68.3	31.7	70.3	29.7	67.2	32.8
Total	290		290		290		290	

Independent variable was represented by the following characteristics: the place where the preparatory preschool program was attended (a preschool institution, a school), the child's gender (boys, girls) and the parents' level of education (primary/secondary school, college/university degree).

Data Collection

The data necessary for the research were collected through oral examination of children. Each child has been tested individually. The test comprised three sections with four questions in each. In the first section, children were shown pictures of solid geometric shapes: cube, rectangular prism, ball and cylinder stripped of all materiality, and the children's task was to correctly recognize and name each shape (Figure 1). In the second section, children were shown pictures of plane shapes: square, circle, triangle and rectangle, with the same task (Figure 2). The third section involved real objects shaped like a cube, rectangular prism, ball and cylinder, and the children's task was to name the shape of the object (Figure 3). Testing was conducted by the authors of this paper in kindergarten classrooms and in the presence of their preschool teachers. Each child from the sample has accepted to participate in the research, and we also obtained the consent of their parents. All children are from a middle-class background and have been chosen according to the principle of random sampling. Children's responses are recorded on a record sheet containing information on each child (place where they attended the preparatory preschool program, gender, education level of the parents). Children's responses were expressed in the form of points. Each correct answer was worth 5 points. Since each of the three sections contained four questions, the maximum number of points a child could win was 60. We obtained data on the education level of parents from the class register.

A pilot study was conducted with 50 children. The pilot study revealed that questions were understandable. Two mathematics teachers graded the questions in this study independently, in order to provide their scoring reliability. The Cronbach's alpha coefficients calculated for each task ranged between .76 and .91. Discrimination of the test was determined by item analysis. The coefficient of discriminative value of task in the test varies from .14 to .25, which shows that the tasks were discriminative enough, because the coefficient is greater than .12 (Bandur et al., 2008: 137).

Data Analyses

The data obtained in the research were processed with the statistics software package IBM SPSS20. In the first part of the paper, data are expressed quantitatively in the form of frequencies and percents, to get a general insight into the number of children who possess a "developed" (are able to recognize and name a solid shape or plane shape) or "undeveloped" geometric concept (are unable to recognize or name a given solid or plane shape). The influence of independent variables on children's success on the test and the examination of differences among children with regard to their gender, place where they attended the preparatory preschool program and education level of their parents were tested with a single factor analysis of variance (ANOVA) for independent samples.

RESEARCH RESULTS AND DISCUSSION

The curriculum of preschool mathematics education anticipates that children should develop the concepts of geometric plane figures and geometric space figures. We determined the development of geometric concepts in children by examining their ability to:

- recognize and name geometric figures in space,
- recognize and name geometric figures in a plane and
- recognize and name geometric shapes on the objects in their surroundings.

First, we wanted to determine if the children had developed concepts of geometric space figures on a purely visual level, according to Van Hiele, and starting from the attitude of Piaget and Inhelder (1967) that the child can recognize and name figures, but not identify connections and relations between figures. Children were shown the following geometric figures in space: cube, rectangular prism, ball and cylinder (Figure 1).

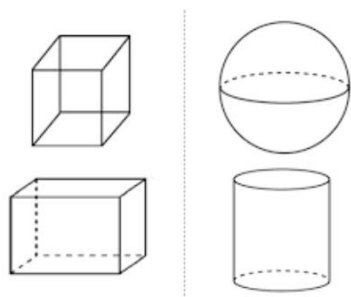

Figure 1. Task from the test

As it can be seen from **Table 2**, most children can recognize and name the cube (240 or 82.8%) and the sphere (219 or 75.5%). Then we have the cylinder (152 or 52.4%), and the smallest number of children (48 or 16.6%) have a developed concept of the rectangular prism.

Table 2. Development of the concept of geometric figures in space in preschool children

Geometric figures	Developed		Undeveloped		Total
	f	%	f	%	
Cube	240	82.8	50	17.2	290
Rectangular prism	48	16.6	242	83.4	290
Cylinder	152	52.4	138	47.6	290
Sphere	219	75.5	71	24.5	290

The result, according to which children’s most developed concepts at the beginning of schooling are those of the cube and the sphere, was to be expected. F. Fröbel emphasized that the most familiar shapes for a child of preschool age were the sphere and the cube, which, according to him, represented “mathematically pure forms with distinct contradictions” (according to: Prentović, 1998: 277–278). Also, geometry, in the opinion of Van Hiele “begins with play” (1999: 310), and children in the earliest period of their lives usually play with objects in the form of a sphere and a cube.

The next task was to examine children’s ability to recognize and name geometric figures in a plane (square, triangle, circle and rectangle). Children were shown images of a square, triangle, circle and rectangle, then asked to name them (**Figure 2**).



Figure 2. Task from the test

Research results show that most children from the study sample (281 or 96.9%) have a developed concept of the circle (they recognize and can correctly name the circle). Slightly lesser number of children (226 or 77.9%) has a developed concept of the triangle. The rectangle was recognized and correctly identified by 176 or 60.7% of children, and the smallest number of children (166 or 57.2%) has a developed concept of the square (see **Table 3**).

Table 3. The development of the concept of geometric figures in a plane in preschool children

Geometric figures	Developed		Undeveloped		Total
	f	%	f	%	
Square	166	57.2	124	42.8	290
Circle	281	96.9	9	3.1	290
Triangle	226	77.9	64	22.1	290
Rectangle	176	60.7	114	39.3	290

Other authors obtained similar results while studying these concepts. Twenty-five years ago, K.C. Fuson, and C. Murray (1978) determined that 85% of children aged five could recognize the circle, 80% the triangle, and 78% the square. In addition, these authors state that as much as 60% of children aged three and older can recognize and correctly identify the circle, the square and the triangle. Researching this problem, D.H. Clements and his associates present their conclusions, according to which 90% of children aged three years and five months to four years and four months can successfully recognize and identify the circle, whereas the same shape is successfully recognized and identified by 99% of children aged six (Clements et al., 1999: 200–201). Other authors came to the conclusion that children have misconceptions, especially about the rectangle and triangle shapes, and that they have the least misconception about the circle shape (Clements & Sarama, 2000a; Kesicioğlu, Alisinanoğlu & Tuncer, 2011). Studies of Clements and his associates show that 96% of the children could fully recognize circles. Although the children consider equilateral quadrangle as a square, 87 % could fully recognize squares. It is highlighted that little children are less successful in recognizing triangles (60%), this level is even lower for rectangles (54%) and children also have a tendency to define parallel edges as a rectangle (according to: Kesicioğlu, 2013, p. 48–49).

The level of development of geometric concepts is further illustrated by the children’s ability to spot and name geometric concepts in their surroundings. Children were shown objects shaped like a ball, cube, cuboid and cylinder (Figure 3).

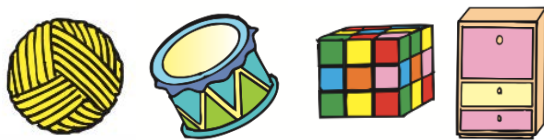

Figure 3. Task from the test

Most children recognize the shape of the cube (241 or 83.1%) and the sphere (240 or 82.8%) in objects in their surroundings (Table 4). Cylinder is recognized by only half of the children (147 or 50.7%), and the rectangular prism by only 52 or 17.9% of children.

Table 4. Development of the ability to spot and name geometry concepts on objects in the surroundings

Geometric figures	Developed		Undeveloped		Total
	f	%	f	%	
Sphere	240	82.8	50	17.2	290
Cube	241	83.1	49	16.9	290
Rectangular prism	52	17.9	238	82.1	290
Cylinder	147	50.7	143	49.3	290

If we compare these results with the results we obtained by testing the children’s ability to recognize and name geometric figures in space, in pictures devoid of any materiality, we can see they are almost identical. A slightly larger number of children recognized and correctly named the sphere on the objects of that shape, than in the picture which depicted a geometric image of the sphere.

If we view the results as a whole, children scored on average 37.71 points, out of the maximum 60, with a standard deviation 13.061 (Table 5) on the test for determining the development of geometric concepts.

Table 5. Development of geometry concepts in preschool children

N	Min	Max	Mean	Std. Error	Std. Deviation	Skewness	Kurtosis
290	5	60	37.71	.767	13.061	-.134	-.466

Therefore, preschool children scored on average slightly more than a half of the maximum number of points on the test which measures the development of geometric concepts. The concepts of the sphere, cube and circle are more developed than the concepts of the cylinder, rectangular prism, rectangle, triangle and square.

In **Figure 4**, we can see there is an approximately normal distribution of the number of students by the number of points scored on the test. The maximum 60 points was scored by 26 or 8.97% of children, and 15 or 5.17% scored 55 points. Most children from the sample (91 or 31.4%) scored between 35 and 40 points, whereas only six or 2.1% of children scored less than ten points. These results simultaneously tell us there is not a single child who does not have at least one developed geometric concept.

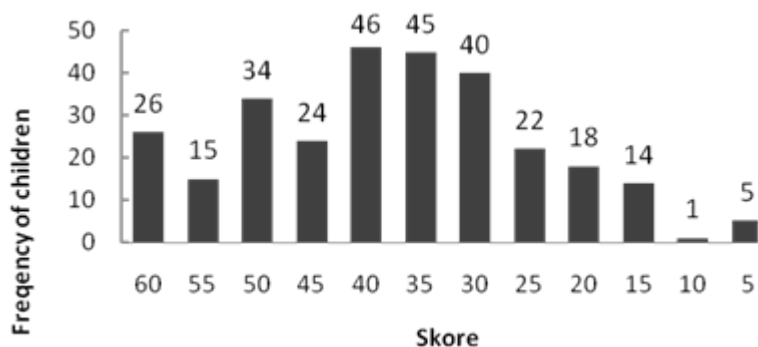

Figure 4. Frequency of children by the number of scored

As we can see, geometric concepts, viewed individually, are unevenly developed in preschool children. The reason for this lies in the very nature of geometric concepts, because some of them are intuitively more familiar to children, but a part of the responsibility must be placed on the organizers of preschool mathematics education.

We wanted to determine if there were any differences in the level of development of geometric concepts, dependent on the place where children attended the preparatory preschool program, primarily because of the fact that children who were educated in preschool institutions, had preschool mathematics education for four years, whereas children who were a part of special classes in primary schools, had it for only one year.

Research results show that children who attended the preparatory preschool program in a preschool institution scored on average 37.63 points on the test, which is approximately the same as children who attended the preparatory preschool program in special classes in primary schools, and scored on average 37.88 points (**Table 6**). By testing the statistical significance of the difference, we determined that it is not statistically significant ($F = .24$, $p = .878$).

Table 6. Development of geometry concepts in children, dependent on the place where they attended the preparatory preschool program

Place	N	M	SD	F	p
Preschool institution	92	37.88	13.056	.024	.878
Primary school	198	37.63	13.096		
Total	290	37.71	13.061		

We can conclude that the development of geometric concepts does not depend on the place where the preparatory preschool program was realized, and neither does it depend the duration of the program, i.e. whether children were a part of the preparatory preschool program since they were three, or just for one year before their primary education started. Our findings lead us to a conclusion that when it comes to the development of geometric concepts, same effects are achieved by preschool teachers who work with children for a year, as well as those who have a chance to work with children for four years in a preschool institution. These results stem from the fact that both groups of preschool teachers organize their work with children of approximately the same abilities, in approximately the same conditions, on the basis of the unified curriculum, which has clear objectives. Thus, children whose preschool education lasts longer, achieve the same results in developing geometric concepts as children who had preschool education for one year only. It should be also said that these results are an effect of preschool teachers' efforts to achieve designated objectives, which are defined and regulated in the *Guidelines on the Basis of Preschool Curriculum* (2006).

It is interesting to note that certain studies found that boys were more successful in spatial cognition (Levine et al., 1999), as well as in recognizing certain geometric shapes (rectangle and square) than girls, whereas there were no differences in recognizing the circle and the triangle (Kesicioğlu, 2013: 52). Explanation for these results, and the preschool boys' superiority in geometry are explained by the fact that boys spend more time playing with various models with which they construct and build space (Lego and other blocks), solve various spatial tasks, that they are often in the situation to copy and build three-dimensional models (Levine et al., 2005), compared to girls, who are more focused on social interaction. Therefore, we wanted to examine if there were any differences in the development of geometric concepts between boys and girls.

Boys scored on average 38.37 points on the test, and girls 37.08 points (Table 7). The difference between the obtained average results, which is 1.29 points in favor of the boys, is not statistically significant ($F = .704$, $p = .402$), which further implies that there are no significant differences in the development of geometry concepts between boys and girls.

Table 7. Development of geometry concepts by to the gender of children

Gender	N	M	SD	F	p
Boys	141	38.37	12.443	.704	.402
Girls	149	37.08	13.632		

Given the role of the child's family in this period of life, and the findings that "families can enhance the development of mathematical knowledge and skills as they set expectations and provide stimulating environments" (Cross, Woods, & Schweingruber, 2009: 343), we wanted to examine whether parents' level of education could influence the development of geometric concepts of children at the beginning of schooling (Table 8).

Table 8. Development of geometry concepts in preschool children compared to parents' level of education

Parent	Parents' level of education	N	M	SD	F	p
Father	primary/secondary school	204	36.50	12.936	6.025*	.015
	college/university	86	40.58	12.980		
Mother	primary/secondary school	195	36.56	12.992	4.614*	.033
	college/university	95	40.05	12.954		

* $p < .05$

In Table 8, we can see that children whose fathers have a college or a university degree were more successful on the tests of the development of geometric concepts, with an average 40.58 points, than children whose fathers had primary or secondary education only, who scored 36.5 points on average. By testing the statistical significance of the observed difference, which is 4.08 points in favor of children whose fathers have a higher level of education, we can say that it is statistically significant ($F = 6.025$, $p = .015$) at the level of .05. Thus, the father's level

of education has a significant impact on the development of geometric concepts of children at the beginning of schooling.

We get similar results when we compare the development of geometric concepts of children against the mother's level of education. Children whose mothers have a college or a university degree achieved better results (40.05 points), compared to children whose mothers only have primary or secondary education (36.56 points). Obtained variance between the two groups ($F=4.614$, $p = .033$) shows that the difference of 3.49 points in favor of children whose mothers have a higher level of education is at the level 0.05 of significance. Similar results were obtained while testing the level of development of the term natural number (Špijunović & Maričić, 2011: 507). However, the question is if this difference is a consequence of the greater ambition of parents with higher level of education, the fact that they have a greater mastery over mathematical contents, that their free time spent with their children is used for developing some geometric concepts, that their ambition concerning their children's education are greater, or some other reason. Either way, it is certain that family has an important role in children's mathematics education, because parents are the first teachers their children have.

CONCLUSION

Despite the fact that geometric concepts are materialized in reality, that they exist for real in the child's surroundings, that the child encounters them on daily basis during various activities, from studying to playing, they are still abstract, and complex to adopt. Studying the effects of preschool mathematics education on the development of geometric concepts in preschool children, we came to the following conclusions:

- when it comes to geometric figures in space, the most developed concepts are *the cube* (82,8%), *the sphere* (75,5%), whereas, only 16,6% of children can recognize and name *the rectangular prism*;
- when it comes to geometric figures in the plane, the most developed concepts are those of *the circle* (96,9%), then *the triangle* (77,8%), whereas, *the rectangle* is recognized and correctly named by 60,7% of children, and *the square* by 57,2% of children;
- children are more successful in recognizing and naming the geometric shapes of *the cube* and *the sphere*, than *the rectangular prism* and *the cylinder*;
- there are no significant differences in the development of geometric concepts between children who attended the preparatory preschool program in a preschool institution, and those who attended it in special classes within a primary school;
- there are no significant differences in the development of geometric concepts between boys and girls;
- parents' level of education has a significant impact on the development of geometric concepts in children.

Results obtained are consistent with the results from literature that refer to the development of geometry concepts and the fact that children of preschool age can form concepts of geometric shapes. We haven't been able to find similar research, organized with the same goal – to examine the effects of organized work with children in preschool mathematics education on the development of geometry concepts in similar or identical context.

The research has shown that preschool mathematics education achieves significant effects developing geometry concepts in children. However, we should bear in mind that preschool mathematics education does not achieve equal effects on the development of all geometry concepts covered by the curriculum of preschool education. Children have more knowledge about and more clear ideas on certain concepts (cube, sphere, circle), whereas some other concepts (cuboid, cylinder) are less developed. Also, the research has shown that children have more success in identifying and naming geometric shapes on objects in their environment, than when they observe these same shapes as geometric images devoid of materiality, which is a consequence of the child attachment to concreteness and his limited abilities for abstraction.

The results imply that the development of mathematical concepts should be placed in a realistic context familiar to the child, and that models should be taken from their surroundings. Special emphasis should be put on naming of the toys which represent models of solid geometric shapes, because many toys are associated with the cube, and some even have the word cube in their name (Lego, puzzle cubes, etc.), although they are not actually shaped like a cube, or even a cuboid.

In addition, the results show that children have more developed ideas about two-dimensional concepts, compared to three-dimensional concepts. This result is interesting, especially because of the fact that three-dimensional shapes are closer to children in the material sense, because children encounter them in everyday life through models, unlike geometric shape in a plane which are devoid of materiality. All this suggests that, despite the fact that geometry concepts are materialized in reality, that they really exist in the child's environment through their models, that the child encounters them daily in various activities, from games to learning, they are abstract and complex to adopt. Preschool teachers especially should keep this in mind, because they should plan the organization of activities the result of which should be the development of geometry concepts, integration of mathematics education with other forms of cognition, the need for further studying of this problem and improvement of preschool teachers' work in this field. In addition, the development of geometry concepts in preschool children should be organized through activities which require the child's maximum engagement, activities where learning is based on the experience of the child, in the context of real life and on sources of knowledge familiar to the child.

Given the importance of early mathematics education for later success in learning and the acquisition of mathematical contents, the results obtained in this research indicate the implications important for the practice. The research showed that preschool mathematics education can significantly contribute to the development of mathematical concepts in preschool children, but also that teachers who organize the work in this field should pay more attention to the development of certain mathematical concepts. We should bear in mind that boys and girls have equal abilities for developing geometry concepts, but also that the child's family has a significant role in preschool mathematics education. The result by which children from families with higher level of education have more developed geometry concepts shows that children's development of geometry concepts depends on adults and their environment in general, which further indicates that there are possibilities for improving work with children within preschool institutions. Activities aimed at developing geometry concepts should be undertaken on daily basis, using play and free activities, and should be integrated with all other areas of knowledge, instead of targeting this particular area exclusively.

The research also has certain limitations that can be used as guidelines for future research on the effects of preschool mathematics education on the development of mathematical concepts in children. The method of collecting data using a structured interview is also the cause of certain limitations. Observation of children would perhaps yield more reliable results. The results would be more complete if preschool teachers' opinions on the process of preschool mathematics education had been collected, and if we had examined their teaching methods.

REFERENCES

- Bandjur, V., Kundačina, M., & Brkić, M. (2008). *Testovi znanja u funkciji ocenjivanja učenika*. Užice: Učiteljski fakultet.
- Beskin, N. M. (1948). *Metodika geometrije*. Beograd: Znanje. Beograd: Prosveta.
- Bodovski, K., & Farkas, G. (2007). Mathematics growth in early elementary school: The roles of beginning knowledge, student engagement, and instruction. *The Elementary School Journal*, 108(2), 115-130.
- Clements, D. H., Swaminathan, S., Hannibal, M. A. Z., & Sarama, J. (1999). Young children's concept of shape. *Journal for Research in Mathematics Education*, 30(2), 192-212.
- Clements, D. H., & Sarama, J. (2000a). Young children's ideas about geometric shapes. *Teaching Children Mathematics*, 6(8), 482-488.
- Clements, D. H., & Sarama, J. (2000b). The earliest geometry. *Teaching Children Mathematics*, 7(2), 2-86.
- Clements, D. H. (2001). Mathematics in the preschool. *Teaching Children Mathematics*, 7(5), 270-281.

- Clements, D. H., & Sarama, J. (2007). Early Childhood Mathematics Learning. In F. K. Lester (Ed.), *Second Handbook of Research on Mathematics Teaching and Learning* (pp. 461–555). New York: Information Age.
- Cross, C., Woods, T., & Schweingruber, H. (2009). *Mathematics Learning in Early Childhood*. Washington: The National Academies Press.
- Čebić, M. (2006). *Početo matematičko obrazovanje predškolske dece*. Beograd: Učiteljski fakultet.
- Dahlberg, G., & Moss, P. (2005). *Ethics and politics in early childhood education*. London: Routledge Falmer.
- Dejić, M. (2003). *Metodika nastave matematike*. Jagodina: Učiteljski fakultet u Jagodini.
- Denton, K., & West, J. (2002). *Children's reading and mathematics achievement in kindergarten and first grade*. Washington, DC: National Center for Education Statistics. NCES 2002-125. (Презето 11.9.2016. <http://nces.ed.gov/pubsearch/pubsinfo.asp?pubid=2002125>)
- Develi, M. Orbay, K. (2003). İlköğretimde niçin ve nasıl bir geometri öğretimi. *Milli Eğitim Dergisi*, Sayı 157.
- Dobrić, N. (1979). *Razvijanje početnih matematičkih pojmova u predškolskim ustanovama*. Beograd: Pedagoška akademija za obrazovanje vaspitača predškolskih ustanova.
- Freudenthal, H. (1973). *Mathematics as an educational task*. Netherlands: Reidel Publishing Company, Dordrecht–Holland.
- Fuson, K. C., & Murray, C. (1978). The haptic-visual perception, construction, and drawing of geometric shapes by children aged two to five: A Piagetian extension. In R. Lesh and D. Mierkiewicz (Eds.). *Concerning the Development of Spatial and Geometric Concepts* (pp. 49–83). Columbus, OH: ERIC Clearinghouse for Science, Mathematics and Environmental Education.
- Guidelines on the Basis of Preschool Curriculum*. (2006). Belgrade: Educational Review.
- Jordan, N. C., Kaplan, D., Ramineni, C., & Locuniak, M. N. (2009). Early math matters: Kindergarten number competence and later mathematics outcomes. *Developmental Psychology*, 45(3), 850-867.
- Kesicioğlu, O. S., Alisinoğlu, F., & Tuncer, A. T. (2011). The analysis of kindergarteners' recognition degrees of geometric shapes. *Elementary Education Online*, 10(3), 1093-1111.
- Kesicioğlu, O. S. (2013). The effect of gender and computer use variables on recognition of geometrical shapes in preschool children. *International Journal on New Trends in Education and Their Implications*, 4(3), 48-56.
- Law on Primary Education*. (2014). Belgrade: Educational Review.
- Levenson, E., Tirosh, D., & Tsamir, P. (2011). *Preschool Geometry, Theory, Research, and Practical Perspectives*. Rotterdam: Sense Publishers.
- Levine, S. C., Huttenlocher, J., Taylor, A., & Langrock, A. (1999). Early sex differences in spatial skill. *Developmental Psychology*, 35(4), 940–949.
- Levine, S. C., Vasilyeva, M., Lourenco, S., Newcombe, N., & Huttenlocher, J. (2005). Socioeconomic status modifies the sex difference in spatial skill. *Psychological Science*, 16, 841–845.
- National Association for the Education of Young Children & National Council of Teachers of Mathematics (NAEYC & NCTM). (2002). *Position statement. Early childhood mathematics: Promoting good beginnings*. (Retrieved from <http://www.naeyc.org/resources/position-statements/psmath.htm>).
- Organisation for Economic Cooperation and Development (OECD). (2001). *Starting strong: Early Childhood Education and Care*. Paris: OECD.
- Penn, H. (2002). The World Bank's view of early childhood. *Childhood*, 9(1), 118-132. doi:10.1177/0907568202009001008
- Prentović, R., & Sotirović, V. (1998). *Metodika razvoja početnih matematičkih pojmova*. Novi Sad: Didakta.
- Piaget, J., & Inhelder, B. (1967). *The Child's Conception of Space*. New York: Norton.
- Seefeldt, C., & Wasik, B. A. (2006). *Early education: three-, four-, and five-year-olds go to School*. Upper Saddle River: Pearson Education.
- Stewart, R., Leeson, N., & Wright, R. J. (1997). Links between early arithmetical knowledge and early space and measurement knowledge: An exploratory study. In F. Biddulph & K. Carr (Eds.), *Proceedings of the Twentieth Annual Conference of the Mathematics Education Research Group of Australasia*, Vol. 2, (pp. 477–484). Hamilton, New Zealand: MERGA.

- Špijunović, K., & Maričić, S. (2011). Razvijenost pojma prirodnog broja kod dece na početku školovanja. u K. Špijunović (Ur.): *Nastava i učenje: stanje i problemi* (pp. 501–510). Užice: Učiteljski fakultet.
- Van Hiele, P. M. (1986). *Structure and Jusight, a Theory of Mathematics Education*. Academic Press, INS.
- Van Hiele, P. M. (1999). Developing Geometric Thinking throught Activities That Begin with Play. *Teaching Children Mathematics*, 6, 310–316.
- Wheatley, G. H. (1990). Spatial sense and mathematics learning. *Arithmetic Teacher*, 37(6), 10–11.
- Yeşil Dağlı, Ü., Halat, E. (2016). Young Children's Conceptual Understanding of Triangle. *Eurasia Journal of Mathematics, Science and Technology Education*, 12(2), 189-202. doi: 10.12973/eurasia.2016.1398a

<http://www.ejmste.com>



For print copies of this issue or articles please send an e-mail to:

print@modestum.co.uk



OPEN ACCESS

EURASIA Journal of Mathematics Science and Technology Education
ISSN: 1305-8223 (online) 1305-8215 (print)
2017 13(9):6189-6201
DOI: 10.12973/eurasia.2017.01058a



Analysis of Students Engagement and Learning Performance in a Social Community Supported Computer Programming Course

Yu-Sheng Su

National Central University, TAIWAN

Ting-Jou Ding

MingDao University, TAIWAN

Chin-Feng Lai

National Cheng Kung University, TAIWAN

Received 20 April 2017 • Revised 30 June 2017 • Accepted 26 July 2017

ABSTRACT

In Taiwan, the social community, Facebook has been more and more powerful ever since being launched, and it serves as if a strong magnet, attracting teachers and students to share and discuss on such platform, and also to search for films, pictures, and messages of their specific interests. Some researchers have probed into the learning interaction and efficacy of a computer programming course, and the results show that not only could the learning interactions between teachers and students enhance, but also between students themselves under this environment supported by Facebook. We propose four steps of learning analytics to study students' behaviors and learning performances in a social community supporting computer programming course. Furthermore, our learning analytics method could decrease the time and energy consuming process, which includes collecting, correlating and organizing students' participative patterns. A reported case, focuses on students' engagement behaviors and its influence on students' learning outcomes, is carried out with 43 freshmen at a university in northern Taiwan. The results show that our learning analytics method benefits students' participative behaviors, which are related to students' learning achievements in the computer programming course supported by social community, since students could obtain better understanding under such learning mode.

Keywords: social community, engagement, learning analytics, computer programming

INTRODUCTION

After Facebook, a social community site, has been launched, it has become more and more powerful since many people could reach the educational purpose of creating, sharing, and discussing knowledge by using it as a multifunctional medium (Garrison, Anderson, & Archer, 2001; Sherry, Michael, & Jason, 2011). Having the feature of being limited by neither time nor location, users can share knowledge, seek for certain answers or share the after-class feedbacks by posting questions on such learning community anytime and anywhere. Meanwhile, the teacher may also respond to students' questions at any time, and the students can also see all the contents posted by others. Therefore, this social community becomes more and more efficient for learning computer programming due to the fact that users are not restricted by a particular time or location. Since the students do not speak directly in front of their fellows in class or after class, therefore those who are shy or introverted are also able to participate in Facebook

© **Authors.** Terms and conditions of Creative Commons Attribution 4.0 International (CC BY 4.0) apply.

Correspondence: Chin-Feng Lai, No.1 University Rd. Tainan 70101, Taiwan.

✉ cinfon@ieee.org cinfon@gmail.com

State of the literature

- According to past literature, we found that learning computer programming courses has become more efficient due to the social community, Facebook, since this type of medium is helpful for learning in the field of computer programming education, and so, it turns out to be a social learning space for computer programming course discussions and feedback sharing among the students.
- Some literatures point out that it is a must to integrate the social community Facebook technology with learning computer programming to find patterns in students' participative and interactive behaviors.
- The use of educational data mining technologies can be utilized to sustain four steps of learning analytics. Previous studies, which had been published in this decade, have predicted that learning analytics would gradually turn into an integral part of the computer programming course.

Contribution of this paper to the literature

- In this paper, we propose the learning analytics method in four steps, namely data collection, data storage, data analysis, and data visualization.
- We propose four steps of learning analytics to explore the influence of students' engagement and interaction behaviors on students' learning performance. Moreover, we examine whether students' engagement behaviors are different in terms of students' learning performance.
- In the social community which supports the computer programming course, we discuss the relationships between students' engagement behaviors and learning performances. The proposed learning analytics is hoped to discover the participative and interactive behaviors of the students so as to promote students' learning effectiveness.

discussions enthusiastically, and so does expressing their thoughts and opinions well (Jeong, 2003; Hou, Chang, & Sung, 2010; Sherry, Michael, & Jason, 2011).

Some studies indicate the benefits of learning computer programming from such learning community as Facebook (Kabilan, Ahmad, & Abidin, 2010; Mazer, Murphy, & Simonds, 2007; Mazman & Usluel, 2010). Not only the communicating chances between the teacher and the students could be increased, but also the interactions among the students. Compared to traditional forums, students tend to devote themselves to Facebook discussions with higher participation and concentration (Hou, Chang, & Sung, 2010; Kabilan, Ahmad, & Abidin, 2010; Su, Huang, Wu, & Su, 2016). Facebook has such characteristics as achieving knowledge sharing, interactive cooperation, mutual communication, recording students learning progress and building up personal relationships. And thus, Facebook is helpful for a learning community which is set in the environment of a college classroom because a learning community like this could become a virtual learning space for community discussions, and exercising feedback sharing would be much easier for teachers and students.

In this paper, we propose four steps for learning analytics in order to study students' engagement behaviors and learning performances in the social community enabled computer-programming course. The proposed learning analytics method consists of four steps, namely data collection, data storage, data analysis, and data visualization. Moreover, we would adapt social community Facebook and education data mining techniques in this study to carry out the learning computer programming activity with least effort, and then we could grasp and analyze students' learning behaviors. Both the teacher and students can discuss, inquire, and share on such platform in order to allow the students to gain more associated information and knowledge, and also deeper learning and thinking in the learning computer programming activity could be achieved. This experiment is set up at a university in northern Taiwan, which involves 43 freshmen. The whole learning activity lasts for 12 weeks. Two research problems would be raised as the following.

Question 1: How do students attend the Facebook learning community in the computer programming course?

Question 2: Are students' participative and interactive behaviors related to their learning outcomes?

LITERATURE REVIEW

Social Community Supporting Computer Programming

In Taiwan, it is pretty usual to apply social networking websites to the educational environment of social community. By explaining “social” and “community” individually, “social” would be like a group gathering people with common hobbies, interests, or purposes while “community” means that any users who knows the basics of computer functions, are able to communicate, exchange, and share information with different communities at the networking space by utilizing a virtual space which is connected to the Internet via computer hardware. Thanks to the highly informal environment on such social networking website as Facebook, the users can interact, cooperate, participate, share information, and place themselves to possible critical thinking extendedly during after school hours (Boulos & Wheelert, 2007; Mazman & Usluel, 2010). According to its informal environment, applying social networking websites for supporting the computer-programming course could allow the students to learn inadvertently and happily. Mazman and Usluel (2010) found out that the social networking websites in daily lives is closely related to the educational environment. Social networking websites could connect users, time, locations, and object contents easily in everyday life. Boulos and Wheelert (2007) have successfully applied the social software to the social community learning activity. The researchers point out that high opportunities would students share and respond to problems in the social community learning activity under the environment of actual social community combined with useful learning information techniques. By this means, students can handle problems easily in extracurricular time by making use of their past experience, in other words, they are able to analogize the old questions and solutions to the problems they encounter at present.

In recent years, many benefits could be seen from research probes applying the social community, Facebook, to the environments of learning computer programming (Cheung, Chiu, & Lee, 2010; Sherry, Michael, & Jason, 2011; Wang, Li, Feng, Jiang, & Liu, 2012; Lin, Hou, Wu, & Chang, 2014; Su, Yang, Hwang, Huang, & Tern, 2014; Su, Huang, & Yang, 2015). Sherry, Michael, and Jason (2011) indicate that Facebook has been identified as a potential educational tool because many university students widely use it. Applying Facebook to the activities of learning computer programming may increase not only its utilization but also students’ interests. Cheung, Chiu, & Lee (2010) mention that Facebook is a student-friendly and student-focused environment which trains students how to self-control, also, friends’ invitations are sent socially without any coercion. Su, Huang, & Yang (2015) find out that Facebook can not only encourage students to discuss and answer related problems, but also promote students’ learning motivation by utilizing the computer programming courses supported by Facebook. Wang, Li, Feng, Jiang, & Liu (2012) find that once the learning activities are adequately designed in the computer-programming courses, it can increase students’ willingness of interaction. By doing so, it not only helps satisfy students’ needs of growing the knowledge and skills of computer programming, but also raises the effectiveness of computer programming.

As for the benefits of adapting social community for supporting computer programming, we found that the social community, Facebook, has provided a multifunctional platform since sharing network information can be clicked into or discussed via the hyperlinks of any audios, videos, and words etc. The advantage of Facebook lies in the power of collective wisdom, and further encouraging students by “establishing relationships for the route of gaining knowledge” with the interactive knowledge creation and digital contents. Kabilan, Ahmad, and Abidin (2010) raise that the characteristics of Facebook are that students can construct individual knowledge sharing and supporting group interactions through participating in the social community which supports computer programming activity. Besides, it can produce and format specific feelings and knowledge for students. Because learning computer programming is getting more and more popular around the world, all students can contribute one’s own professional knowledge, or obtain resources shared by others via Facebook. The experimental results found out that supporting computer programming with Facebook increases the speed that the students obtain their computer programming knowledge and skills.

In this study, we apply the social community-based learning method demonstrated by Lin, Hou, Wu, and Chang (2013) to a real computer programming activity. In addition to that, this kind of learning method is designed

into two phases, namely the social community-based notification and discussion. The reason why using Facebook for supporting computer programming activities is because such medium has little restrictions on time and place compared to the traditional face-to-face discussion. Moreover, Facebook provides learners with opportunities to prepare, reflect, think, and search for additional information before participating in the social community discussion. The teacher delivers notification messages by Facebook and decides whether to arrange the Facebook discussion or not after the students respond to the Facebook messages.

Learning Analytics

With the wide adoption of learning analytics in recent decades, some studies have applied education data mining techniques for studying the unknown and unrevealed modes in e-learning environments (Bakeman & Gottman, 1997; Jeong, 2003; Hou, Chang & Sung, 2010; Wang, Li, Feng, Jiang, & Liu, 2012; Lonn, Aguilar, & Teasley, 2015.) Hou, Chang, and Sung (2010), and Lonn, Aguilar, and Teasley (2015) propose learning analysis methods, which is based on educational data mining techniques, to make researches into the association mode and the degree of information literacy and students' participative behaviors. By testing every participations and interactions among the relationships of behaviors and using continuous behavior association, we would come up with a conversion chart. The proposed learning analysis methods try to understand the students' participative and interactive behaviors in the social community supporting computer programming activity.

Based on the learning analysis methods propose by Hou, Chang, and Sung (2010) and Lonn, Aguilar, and Teasley (2015), we apply the learning analysis method to propose four steps for learning analytics so as to study out students' participative and interactive behaviors in the computer programming environments supported by Facebook. The proposed method shows how the users engage themselves into the unknown association and unrevealed modes while utilizing it on Facebook to show learning objects, and also to analyse how learning objects affect students' participations and interactions. Since the social community could promote the effectiveness in the computer programming activity, students could not only gain the appropriate information by teacher's immediate recommendations, but also the response from their fellows on Facebook discussions, and therefore, the students could boost their learning motivations and confidences (Hou, Chang & Sung, 2010; Wang, Li, Feng, Jiang, & Liu, 2012; Lonn, Aguilar, & Teasley, 2015).

As stated in the proposed method for the computer programming supported by social community, we would collect students' learning data at first by recording students' clicking events and accessing time during in the whole activity. When the students encounter problems in the computer programming assignment, the teacher would try to help out in students' computer programming trouble spots by providing important hints on Facebook. The proposed method can analyze and generate useful information for the teachers to improve their instructional design on Facebook-supported computer programming activity. Some studies have illustrated that the system logs adapt education data mining techniques for studying the relationships between online participative behaviors and learning performances (Wang, Li, Feng, Jiang, & Liu, 2012; Lonn, Aguilar, & Teasley, 2015). Because students' participations and interactions might turn out to be different from the behavior patterns when applying the Facebook-supported computer programming course, and may result in affecting their learning performances. However, after the teacher provides help, students should learn to refine their computer programming quality by adjusting their learning result. Finally, understanding how students' participative and interactive behaviors in the social community influence the way computer programming course affects their learning performances is crucial.

FOUR STEPS FOR LEARNING ANALYTICS

In this paper, we propose four steps for learning analytics to explore students' participative and interactive behaviors in the computer programming activity supported by social community Facebook. The four steps for learning analytics includes data collection, data storage, data analysis, and data visualization, shown as **Figure 1**.

Using social community Facebook as the basis and let the teacher conducts the social community-based learning method in the real computer programming course (Su, Huang, & Ding, 2016; Huang, Yang, Chiang, & Su,

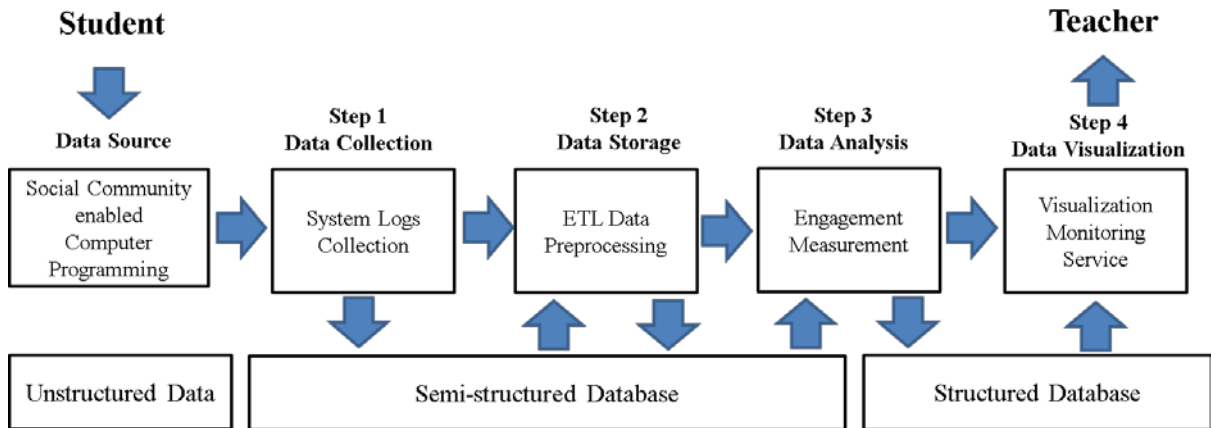

Figure 1. Four steps for learning analytics

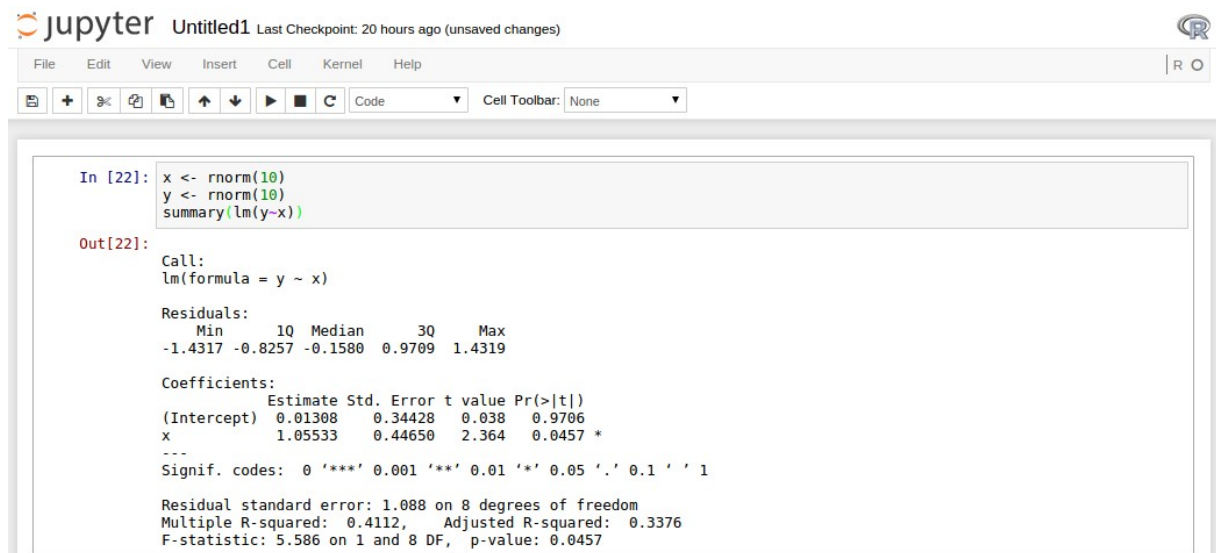

Figure 2. The user interface of the web-based computer programming IDE

2016). The teacher assigns computer programming assignments to students, and students use the web-based computer programming IDE to complete their assignments, as shown in Figure 2. The menu list enables students to manage their project life cycle. Furthermore, we implement a computer programming code development panel on which students developed and tested their computer program and managed code life cycle. In the social community, Facebook, the teacher guides students to share knowledge and cooperative to discuss the computer programming problems. Students read course materials and post issues by the social community Facebook. After the computer programming course supported by social community Facebook, the system logs are a tracking log that records students’ detailed engagements and interactions, such as the student read a lecture material, and the student posts a Facebook message.

And then, we apply the learning analysis method to obtain and deal with gigantic social community information, just like how we use the system logs collection function on social community Facebook obtaining semi-structured information such as the context, results, environment, time, and so on. Through data collection, data storage, and data analysis steps turn unstructured raw data into semi-structured database. After data aggregating and analyzing the structured information saves at the structured database. After that, the final step of the data

visualization with the integrated structured database on the visualization and monitoring service, and carries out the engagement measurement function in the step 3 of data analysis.

At last, we use the visualization monitoring service in connecting with both long and short terms of data for analysis and comparison. Through visualization and monitoring service, they understand the frequency of immediate use on the computer programming course by students, and so is students' participative and interactive behaviors.

Data Collection

We found that the learning activity appears on the social community Facebook is mainly displayed in the concept of timeline. As time passes or if there are too many posts in Facebook, the topics discuss naturally descend quicker. The popular posts do not remain at the top of classification window or discussion area. The students' degree of interaction and information attainment are difficult to measure is because the existence of knowledge is hard to be expressed as numeral data.

In this step, we use the system logs collection module to record users' clicking and accessing event logs in the social community Facebook discussion board and the web-based computer programming IDE. Each recorded raw data comprises four information events, namely who caused the event, what the event was, when the event occurred, and the computer programming assignment when the event occurred. The system logs collection module not only recorded the events of opening and closing the social community Facebook discussion board and the web-based computer programming IDE, but also recorded the event of the mouse focusing in and out of the web-based computer-programming IDE.

By recording these events, we could understand how long a student spent accessing the learning activity and how long he/she focused his/her mouse on the computer programming assignment. The module fetches the clicking events and accessing time data sets from unstructured raw data and stores it in the semi-structured database. Moreover, we convert unstructured raw data into semi-structured database, and the semi-structured information metadata includes contents, authors, time, replied messages, likes, shares, fan page / group name, fan page / number of people, fan page / group link, and picture hyperlink icons etc. After aggregation, the semi-structured information saves at the semi-structured database.

Data Storage

We found that not all semi-structured data is useful for educational data analysis. In this step, we apply the ETL(Extract-Transform-Load) data preprocessing module to extract, transform, and load useful semi-structured information. For example, the semi-structured information contains lecture materials accessed, programming assignments accessed, Facebook posted messages accessed, and programming refinements accessed.

Data Analysis

After formation into columns, we apply the engagement measurement function (Lonn, Aguilar, & Teasley, 2015) to evaluate students' participative and interactive behaviors from lecture materials accessed, programming assignments accessed, Facebook posted messages accessed, and programming refinements accessed. Students' engagement in accessing lecture materials are evaluated when a student clicks lecture materials in the social community Facebook to read a learning material. Students' engagement in accessing Facebook posted messages are measured when a student posts a Facebook message to the learning computer programming activity for replied a posted message. Finally, students' engagement measurement values in the computer programming activity are measured from students' clicking and accessing events. We store the analytics results in the structured database for data visualization in the next step.

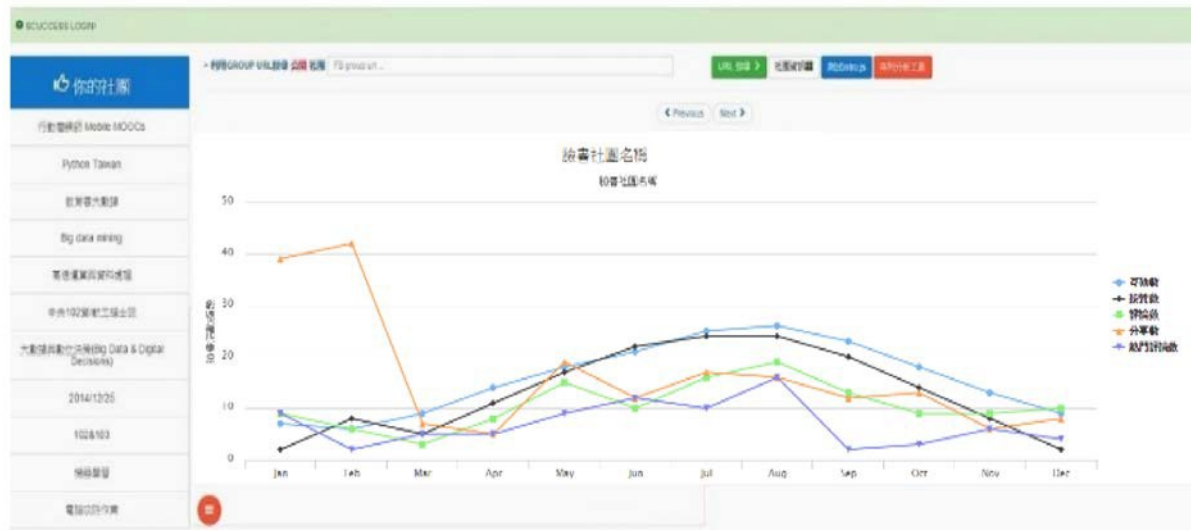

Figure 3. A weekly learning computer programming report in the visualization and monitoring user interface

Data Visualization

To both the long-term and short-term information, comparisons and analyses are made. In final step, our system generates a weekly learning computer programming report for the teacher that includes human-readable information, shown as **Figure 3**. The visualization and monitoring service presents the figures and tables through a web-based interface, which allows the teacher access to the information at any time and from any location. Therefore, the teacher understands the frequency of students' immediate uses, analysis summaries, and action changes in the learning computer-programming activity.

METHODOLOGY

Participants

In this experiment, students attend a case study of the computer-programming course supported by the social community Facebook in a university in northern Taiwan. 43 freshmen students from a class (36 males and 7 females) with an average age of 19 participate in the course entitled 'Introduction to Computer Programming'. The experiment is conducted from October to December in 2016.

In this course, the teacher has teaching experience of computer programming exceeding 6 years. The course unit contents are the data structure units of computer programming. Teaching contents and schedules of the course are according to the teacher. The goal of the course is to develop students learn the concepts of computer programming and related computer programming skills. The students use a certain level of familiarity of using the social community Facebook to undergo computer programming lessons. The social community Facebook supported computer-programming course has all coordinated teaching contents, guiding messages, and expanded teaching materials.

Procedures

In the experimental procedure, we plan 12 weeks to conduct the computer-programming activity supported by social community Facebook. The class time is 150 minutes for each week. In the first 4 weeks, the students learn the basic concept of computer programming. The teacher assigns computer programming

assignments for the students to practice after class. The students can refer to the learning materials published on social community Facebook to learn computer programming knowledge.

This experimental activity had lasted for about 7 weeks. During the activity, students read lecture materials previously provided in the social community Facebook. Students can work jointly on learning computer programming and participate in the Web-based computer-programming IDE to develop their computer programming skills. The teacher and classmates then provide suggestions for refined computer programming assignments in the social community Facebook. When students encounter problems in doing computer programming assignments, the teacher apply the social community-based learning method to intervene in the student' learning activity. After the teacher provides assistance, students learn to refine their computer programming assignment quality by developing their computer programming skills.

The teacher gives feedbacks to students and evaluated the results and the efficiency of the whole learning activity. It likes students would review contents and commented each other on social community Facebook. The students entered Facebook every week at the topic section. They would be able to see the headings of opinions posted with their names with all the students of the course and the teacher who instructed. In addition, the refinement of computer programming assignments is to improve students' learning effectiveness. Moreover, students' computer programming skills are promoted by modifying their computer programming assignment according to the suggestions from social community Facebook.

At the end of the learning activity, we collect students' learning data by recording students' clicking events and accessing time. In the final week, a computer programming test is conducted to obtain students' learning performance.

Instruments

The computer programming test used in this research is designed by the computer programming teacher who had 6 years of teaching experience. This test is conducted to obtain students' learning performance, and it consists of two parts, namely a paper-based test and a computer programming test. The paper-based test evaluates the students' cognitive levels of remembering and understanding. The students are required to answer 15 true/false questions (each correct answer = 2 points) and 10 single selection questions (each correct answer = 2 points). The total score is 50. In the computer programming test, students have to complete two computer programming assignments. The test evaluates students' cognitive levels of applying, analyzing, and integrating. The students are awarded 25 points for each correctly completed computer programming assignments. The total score of the computer programming test is 50. The computer programming test score equals the sum of the scores of the paper-based test and the computer programming test. The Kuder-Richardson Formula 20 (KR-20) reliability test is used to estimate the computer programming test data (Wang, Feng, Jiang, & Liu, 2012). The Cronbach's α value is 0.78, indicating high reliability.

Data Collection and Analysis

There are three kinds of data collected, namely web-based computer-programming IDE system logs, social community Facebook system logs, and students' learning performances. To analyze the data, we apply the clustering method to generate three clusters based on the data analysis step for learning analytics. To compare the students' participative and interactive behaviors and students' learning performances among the three clusters, we use the IBM SPSS software to analyze students' participative behavior data. Before analysis, the dependent variables are checked for normal distribution and homogeneity of variance. All variables violated the assumption of normality, as assessed by a Shapiro-Wilk's test ($p < .05$). To address these violations, and for the sake of consistency, the Kruskal-Wallis nonparametric test is used. The post-hoc test is performed using the Mann-Whitney U test.

The system logs and data provide statistical information for each student on the quantity of lecture materials accessed, the time spent of lecture materials accessed, the quantity of computer programming

Table 1. Descriptive statistics of students' engagement behavioral variables

No.	Variables	Mean	S.D.
1	Time spent accessing lecture materials (second)	5376.36	4698.94
2	Number of lecture materials accessed	36.32	15.32
3	Time spent accessing computer programming assignments (second)	1358.39	1123.68
4	Number of computer programming assignments accessed	20.19	16.86
5	Time spent accessing Facebook posted messages (second)	342.64	467.32
6	Number of Facebook posted messages accessed	18.52	13.82
7	Time spent accessing computer programming refinements (second)	9225.85	6797.75
8	Number of computer programming refinements accessed	36.43	15.68

assignments accessed, the time spent of computer programming assignments accessed, the quantity of Facebook posted messages accessed, the time spent of Facebook posted messages accessed, the quantity of computer programming refinements accessed, and the time spent of computer programming refinements accessed.

1. The quantity of lecture materials accessed is defined that the number of times that a student accesses the lecture materials.
2. The time spent of lecture materials accessed is defined that the amount of time a student spends to access lecture materials.
3. The quantity of computer programming assignments accessed is defined that a student accesses the computer programming assignments to complete it.
4. The time spent of computer programming assignments accessed is defined that the amount of time a student spends to complete computer programming assignments.
5. The quantity of Facebook posted messages accessed is defined that a student posts a Facebook message to the Facebook discussion for replied a posted message.
6. The time spent of Facebook posted messages accessed is defined that the amount of time a student spends to access Facebook messages and reply posted messages.
7. The quantity of computer programming refinements accessed is defined that a student accesses the computer programming assignments to improve it.
8. The time spent of computer programming refinements accessed is defined that the amount of time a student spends to refine computer programming assignments.

The statistical information helps us to understand students' participative and interactive behaviors and the learning performance data contributions of each student.

RESULTS

Descriptive Statistics of Students' Participative Behaviors

During the 12-weeks experimental activity, all students accessed lecture materials, accessed computer programming assignments, accessed Facebook posted messages, and accessed computer programming refinements. **Table 1** shows the means and standard deviations of the variables related to students' participative behaviors in the computer-programming activity supported by social community Facebook. As the descriptions in **Table 1** indicate, the students spend most of their time accessing computer programming refinements, followed by read lecture materials, understood programming assignments, and posted Facebook messages.

The Differences in Participative Behaviors and Learning Performance

We classify the students with similar participative behavioral variables into a homogeneous group, the clustering method for learning analytics is performed on four variables, namely time spent accessing lecture materials, time spent accessing programming assignments, time spent accessing Facebook posted messages, and time spent accessing programming refinements. Before using the clustering method, four variables are transformed

Table 2. Students’ participative behaviors and learning achievements among three clusters

	Intensive Use		Short Use		Regular Use		Kruskal-Wallis Test	Post-hoc Test
	Mean	S.D.	Mean	S.D.	Mean	S.D.	p	
Number of lecture materials accessed	43.13	14.32	17.86	14.23	33.32	14.12	0.000**	cluster1>cluster2** cluster1>cluster3* cluster3>cluster2**
Number of computer programming assignments accessed	31.21	16.86	6.91	6.27	17.48	11.32	0.000**	cluster1>cluster2** cluster1>cluster3** cluster3>cluster2**
Number of Facebook posted messages accessed	28.32	15.82	7.68	10.28	11.31	11.23	0.000**	cluster1>cluster2** cluster1>cluster3** cluster3>cluster2**
Number of computer programming refinements	42.32	13.74	44.83	8.13	35.62	12.56	0.000**	cluster1>cluster2** cluster3>cluster2**
Learning performance	53.12	20.13	36.42	27.67	56.29	19.40	0.036*	cluster1>cluster2* cluster3>cluster2*

*p<0.05, **p<0.01

in order to reduce the bias in the proposed learning analytics method (Lust, Vandewaetere, Ceulemans, Elen, & Clarebout, 2011).

The 33.33% lowest, intermediate, and highest time durations are allocated a value of 1, 2, and 3, respectively, indicating low, moderate, and high accessing time. After using the clustering method, the three clusters are generated. 15 students in the “intensive use” cluster spend more time accessing lecture materials, programming assignments, and Facebook posted messages than the students in the other clusters. 14 students in the “regular use” cluster spend more time accessing programming refinements than students in the other clusters. However, 14 students in the “short use” cluster spend less time accessing any lecture materials, programming assignments and programming refinements than the students in the other clusters.

Because the “short use” cluster accesses computer programming assignments and Facebook posted messages significantly fewer times and spends a shorter time accessed lecture materials, computer programming assignments, and posted messages than the students of the “intensive use” cluster and the “regular use” cluster. Moreover, the “regular use” cluster spends significantly longer average time on each access of students’ participative behaviors, and spends marginally significantly longer students’ participative behaviors and students’ learning performances than the “short use” cluster. In addition, the “intensive use” cluster accesses significantly more times and spends longer accessed lecture materials, computer programming assignments, Facebook posted messages, and computer programming refinements than the “short use” cluster. In **Table 2**, the result gives us a clearer understanding of students’ participative behaviors among the three clusters.

In order to explore students’ participative behavioral variables and learning performances among the three clusters, we apply the Kruskal-Wallis test to compare the three clusters in terms of the quantity of students’ participative behaviors and the average time spent on each student’s participative behaviors. **Table 2** indicated that students in the three clusters significantly demonstrate different participative behaviors and learning performances in the learning activity. After using Kruskal-Wallis test, we apply the post-hoc test to demonstrate statistical significances existed in all comparisons except in the following cases, namely the quantity of lecture materials accessed, the quantity of computer programming assignments accessed, the quantity of Facebook posted messages accessed, the quantity of computer programming refinements accessed, and students’ learning performance, as shown in **Table 2**. When Kruskal-Wallis test is conducted, we examine whether the three clusters are different in terms of students’ engagement behaviors and learning performance. The result shows significant effects of the three clusters on students’ learning performance ($\chi^2 (2, N=43) =32.231, p=0.036$). After using post-hoc test, we reveal statistically significant differences in all comparisons.

CONCLUSIONS AND DISCUSSIONS

In this paper, we propose four steps for learning analytics to explore the influence of students' engagement behaviors on students' learning performances. A 12-weeks case study observes students to attend the computer-programming course supported by social community Facebook. We examine whether students' participative behaviors are different in terms of students' learning performances. Therefore, we address two research questions.

For the research question 1, students attend the computer programming course supported by social community Facebook to find several interesting results based on **Table 1**. The experimental result indicates that students access computer programming refinement processes more often and, on average, spend more time on each access than they do for the other participative behaviors. This result may represent that the students more frequently improve computer programming errors that are directly associated with students' background knowledge. These findings are also consistent with the results of previous studies (Hou, Chang & Sung, 2010; Wang, Li, Feng, Jiang, & Liu, 2012; Lonn, Aguilar, & Teasley, 2015), which found that students' participative behaviors can be promoted through the proposed social community-based learning method. Moreover, students do computer programming assignments more often than other computer programming IDE tools (Lust, Vandewaetere, Ceulemans, Elen, & Clarebout, 2011; Wang, Li, Feng, Jiang, & Liu, 2012; Lonn, Aguilar, & Teasley, 2015). Students can post messages in the Facebook discussion. However, the number of Facebook posted messages accessed is lower than the number of other participative behaviors that are accessed. The reason for the fewer times accessing Facebook posted messages may be that Facebook provided the notification page and discussion function where students could access how many posts they had not viewed. Therefore, the teacher delivers posted messages by Facebook. However, students only respond to teachers' messages, and they do not check other students' questions and new posts.

For the research question 2, we found that students' participative behaviors are related to students' learning performances. We apply the clustering method for learning analytics based on students' engagement behavioral variables to classify the students with similar participative behaviors into distinct groups. **Table 2** shows three clusters, namely the "intensive use" cluster, the "short use" cluster, and the "regular use" cluster are generated. The "short use" cluster performs fewer times and spends a shorter amount of time accessing any of the four kinds of students' participative behaviors compared with the two clusters "intensive use" and "regular use". The two clusters "intensive use" and "regular use" spend the same total amount of time accessing the four types of students' participative behaviors. However, the "intensive use" cluster significantly performs more times and spends more time accessing the lecture materials, computer programming assignments, and Facebook posted messages than the "regular use" cluster, who in turn spend significantly longer on each access and spend marginally significantly longer total time accessing computer programming refinements than the "intensive use" cluster. The results indicated that the students actually demonstrated very different behavior patterns and learning outcomes in the computer-programming activity.

In addition, we found several interesting results in **Table 2**. First, 28% of the students in this study are labeled as "short use" as they infrequently accessed lecture materials, computer programming assignments, and Facebook posted messages. We found that there is a high percentage of students who do not access or who infrequently accessed the online learning tools and resources. Second, we found that the students who had intensively engaged in accessing learning tools and resources could be divided into two types: intensively using all learning tools and resources ("intensive use") and selectively intensively using some learning tools and resources ("regular use"). When Kruskal-Wallis test and post-hoc test are conducted, we found that students' participative behaviors and learning performances among the three clusters are significantly different. The result indicates that the participative behaviors of students are associated with learning performances. In particular, the "intensive use" cluster and the "regular use" cluster obtain significantly higher achievement scores than the "short use" cluster. The result indicates that the students who invest more time and effort in the computer programming activity had better learning effectiveness.

According to our findings, we provide several suggestions for teachers, researchers, and system designers based on our findings. Students' participative behaviors actually affect their learning performances. In particular, the "short use" cluster is lower learning effectiveness. The results suggest that instructional and system designers should devise strategies for motivating students to engage in the computer programming activity supported by social community Facebook. For example, the teacher can send Facebook messages or emails to remind students which doing computer programming assignments they have not accessed, or to recommend Facebook posted messages that can help them complete their computer programming assignments or achieve a higher score in the computer programming outcomes. In addition, the teacher can embed interactive tasks, such as answering questions, in the computer programming course supported by social community Facebook to engage students in accessing them.

ACKNOWLEDGEMENTS

This study is supported in part by the National Science Council of the Republic of China. (MOST 106-2511-S-008-006 and MOST 106-2622-S-008 -002 -CC3)

REFERENCES

- Bakeman, R., & Gottman, J. M. (1997). *Observing interaction: An introduction to sequential analysis (2nd Ed.)*. Cambridge, UK: Cambridge University Press.
- Boulos, M. N. K., & Wheelert, S. (2007). The emerging Web 2.0 social software: An enabling suite of sociable technologies in health and healthcare education. *Health Information and Libraries Journal*, 24(1), 2-23.
- Cheung, C. M. K., Chiu, P. Y., & Lee, M. K. O. (2010). Online social networks: Why do students use Facebook?. *Computers in Human Behavior*, 27(4), 1337-1343.
- Garrison, D. R., Anderson, T., & Archer, W. (2001). Critical thinking, cognitive presence, and computer conferencing in distance education. *American Journal of Distance Education*, 15(1), 7-23.
- Hou, H. T., Chang, K. E., & Sung, Y. T. (2010). Applying lag sequential analysis to detect visual behavioral patterns of online learning activities. *British Journal of Educational Technology*, 41(2), e25-27.
- Hou, H. T., Sung, Y. T., & Chang, K. E. (2009). Exploring the behavioral patterns of an online knowledge sharing discussion activity among teachers with problem-solving strategy. *Teaching and Teacher Education*, 25(1), 101-108.
- Hou, H. T., Wang, S. M., Lin, P. C., & Chang, K. E. (2013). Exploring the learner's knowledge construction and cognitive patterns of different asynchronous platforms: Comparison of an online discussion forum and Facebook. *Innovations in Education and Teaching International*, 52(6), 610-620.
- Huang, S. J., Yang, J. H., Chiang, H. C., & Su, Y. S. (2016). Effects of Situated Mobile Learning Approach on Learning Motivation and Performance of EFL Students. *Journal of Educational Technology & Society*, 19(1), 263-276.
- Jeong, A. C. (2003). The sequential analysis of group interaction and critical thinking in online threaded discussions. *The American Journal of Distance Education*, 17(1), 25-43.
- Kabilan, M. K., Ahmad, N., & Abidin, M. J. Z. (2010). Facebook: An online environment of learning of English in institutions of higher education?. *The Internet and Higher Education*, 13(4), 179-187.
- Mazman, S. G., & Usluel, Y. K. (2010). Modeling educational usage of Facebook. *Computers & Education*, 55(2), 444-553.
- Lin, P. C., Hou, H. T., Wu, S. Y., & Chang, K. E. (2014). Exploring college students' cognitive processing patterns during a collaborative problem-solving teaching activity integrating Facebook discussion and simulation tools. *The Internet and Higher Education*, 33, 51-56.
- Lonn, S., Aguilar, S. J., & Teasley, S. D. (2015). Investigating student motivation in the context of a learning analytics intervention during a summer bridge program. *Computers in Human Behavior*, 47, 90-97.
- Lust, G., Vandewaetere, M., Ceulemans, E., Elen, J., & Clarebout, G. (2011). Tool-use in a blended undergraduate course: In Search of user profiles. *Computers & Education*, 57(3), 2135-2144.

- Wang, Y., Li, H., Feng, Y., Jiang, Y., & Liu, Y. (2012). Assessment of programming language learning based on peer code review model: Implementation and experience report. *Computers & Education, 59*(2), 412-422.
- Sherry D. R., Michael, J., & Jason, H. (2011). Exploring educational and cultural adaptation through social networking sites. *Journal of Information Technology Education, 10*, 1-16.
- Su, Y. S., Huang S. J., & Ding T.-J. (2016). Examining the Effects of MOOCs Learners' Social Searching Results on Learning Behaviors and Learning Outcomes. *Eurasia Journal of Mathematics, Science & Technology Education, 12*(9), 2517-2529.
- Su, Y. S., Huang S. J., & Yang J. H. (2015). Effects of Annotations and Homework on Learning Achievement: An Empirical Study of Scratch Programming Pedagogy. *Journal of Educational Technology & Society, 18*(4), 331-343.
- Su, Y. S., Huang, S. J., Wu, S. Y., & Su, C. N. (2016). Look Taiwan Education Big Data Research and Development. *Springer Lecture Notes in Computer Science (LNCS), 43*, 415-421.
- Su, Y. S., Yang, J. H., Hwang, W. Y., Huang, C. S. J., & Tern, M. Y. (2014). Investigating the Role of Computer-Supported Annotation in Problem Solving Based Teaching: An Empirical Study of a Scratch Programming Pedagogy. *British Journal of Educational Technology, 45*(4), 647-665.

<http://www.ejmste.com>



<http://www.ejmste.com>



<https://twitter.com/ejmste>



<https://www.facebook.com/ejmste>



<http://modestum.co.uk/>



publications@modestum.co.uk



OPEN ACCESS

EURASIA Journal of Mathematics Science and Technology Education
ISSN: 1305-8223 (online) 1305-8215 (print)
2017 13(9):6203-6209
DOI: 10.12973/eurasia.2017.01059a



Study on the Unsafe Acts and Education Function in Coal Mine Accidents Caused by Rescue

Jiang Wei

China University of Mining & Technology (Beijing), CHINA

Zhu Zhi-Ming

China University of Mining & Technology (Beijing), CHINA

Xiang Yuan-Chi

China University of Mining & Technology (Beijing), CHINA

Received 23 April 2017 • Revised 19 July 2017 • Accepted 1 September 2017

ABSTRACT

This paper selects 69 coal mine rescue accidents from 1981 to 2011 in China, focusing on direct unsafe acts and high-frequency unsafe acts that lead to coal mine rescue accidents. Two conclusions can be drawn. The first conclusion is that there are five categories of direct unsafe acts that cause coal mine rescue accidents: not wearing respirators as required, not following the gas detection requirements, the poor abilities of the ambulance crew, technical measures not in place, and the violation of commanding. The first two has a larger proportion, as their sum is 57.97%, more than half. The second conclusion is that out of all relevant unsafe acts, nineteen categories of high-frequency unsafe acts are statistically significant, and 5 types are well-marked due to their higher frequency: not wearing respirators when rescuing, talking through respirator in the underground rescue process, not testing underground gas composition dynamically, not carrying a spare respirator, no pro-examination of the equipment. The analysis results can be used to educate employees and students.

Keywords: education, accidents caused by rescue, unsafe acts, analysis

INTRODUCTION

Coal mine accidents caused by rescue can be classified as objective factors and subjective factors. Objective factors include outdated rescue techniques and equipment. Subjective human factors include more things, such as the commanding errors of the ambulance officers, the violation of commanding, adventurous commanding, improper organization of the rescue operation, physical fitness and psychological quality of ambulance personnel not being strong, etc. Subjective human factors are the main cause of the coal mine accidents.

Foreign researches of mine rescue are in favor of mine rescue mechanism and its management system as well as decision support system research and development of mine rescue operations. Scholars prefer rescue system and rescue techniques in China. Few of them take "accident" as the entry point of analysis, and apply the results for education.

© **Authors.** Terms and conditions of Creative Commons Attribution 4.0 International (CC BY 4.0) apply.

Correspondence: Jiang Wei, Lecturer, *Faculty of Resources & Safety Engineering, China University of Mining & Technology (Beijing), Ding No. 11 College Road, Haidian District, Beijing, Postal code 100083, China*

Tel: +86-13426323576.

✉ jiangwei678@126.com

State of the literature

- Unsafe acts are not carefully classified.
- There is no systematic summary of unsafe acts caused by coal mine rescue accidents.
- Coal mine rescue accident training is not targeted.

Contribution of this paper to the literature

- Refined the types of unsafe acts.
- Five kinds of direct unsafe actions were brought into the coal mine rescue accidents.
- The results show that 19 kinds of high frequency unsafe acts that cause rescue accidents in coal mines should be strengthened, and education and training should be strengthened.

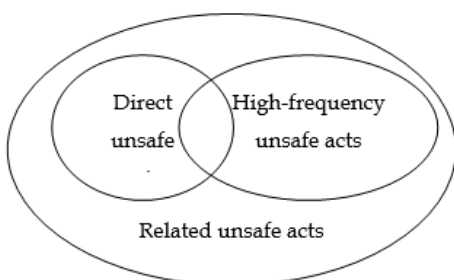

Figure 1. Relationship among direct, related and high-frequency unsafe acts

Therefore, this paper analyzes unsafe acts in coal mine accidents caused by rescue. In the analysis of unsafe acts, direct unsafe acts, which cause these accidents, are stripped out firstly. The categories of direct unsafe acts and specific acts are the focus of analysis. When analyzing related unsafe acts, all unsafe acts are divided and analyzed according to different mechanisms, finding out the high-frequency unsafe acts to provide evidence for the prevention of coal mine accidents caused by rescue. Not only companies can use the research results of unsafe actions to educate employees but also schools can use the results to educate students.

EXPLANATION OF THE CONCEPT OF UNSAFE ACTS

To make the acts of coal mine accidents caused by rescue clear, three concepts in this article relates to unsafe acts; namely: direct unsafe acts, related unsafe acts and high-frequency unsafe acts. Their relationship is as shown in **Figure 1**.

Direct unsafe act of coal mine accidents caused by rescue is the act that cause the accident. A distinctive feature of this act is that it directly causes the accident.

Related acts include both direct unsafe acts that cause the mine rescue accident, but also incentive or unsafe acts that may influence the following evolution of the accident.

High-frequency unsafe acts are those related to unsafe acts with statistical significance. Although these acts don't directly cause the accident, they do have important influence on the occurrence of the accident and its development.

Therefore, this paper focuses on the direct unsafe acts and high-frequency unsafe acts of coal mine accidents caused by rescue.

PRELIMINARY STATISTICS OF UNSAFE ACTS

This paper selects 69 mine rescue accidents from 1981 to 2011 in China, whose level are major, serious or catastrophic (general accidents are not considered). These accidents cover a wide array of different occurrence types

Table 1. Statistical Table of Unsafe Acts in Coal Mine Rescue Accident

No	Type	Specific Form	Number of Times	Proportion
1	Not wearing respirators as required	Not wearing respirators when rescuing	11	16.9%
		Talking through respirator in the underground rescue	8	12.3%
		Removing the respirator without authorization	7	10.7%
2	Not following the gas detection requirements	Not detecting gas in ambulance space before working	9	13.9%
		Not detecting underground gas components dynamically as required	5	7.7%
3	Poor abilities of the ambulance crew	Inability to carry out self and mutual aid in emergency	4	6.2%
		Not carrying rescue equipment like resuscitator	6	9.2%
4	Technical measures not in place	Taking wrong coal mine rescue measures when the underground situation is unclear	5	7.7%
5	Violation of commanding	Forcing rescuers to break into the pit with unknown details	6	9.2%
		Forcing rescuers to work with the awareness of bad rescue condition	4	6.2%

of mine rescue accidents, such as gas explosions, flooding, fire, etc. They also include a wide array of state-owned key coal mines, state-owned local coal mines and township coal mines. Besides, the development of coal mine rescue technology in this period is relatively stable.

By analyzing the acts in 69 coal mine rescue accidents in the sample library, the statistical results of direct acts are given in [Table 1](#).

[Table 1](#) shows that direct unsafe acts of mine rescue accidents have five categories: not wearing respirators as required, not following gas detection requirements, poor abilities of the ambulance crew, technical measures not in place, and violation of commanding. The percentage data in [Table 1](#) is the percentage of direct unsafe actions in the sample, which accounts for the frequency of the direct unsafe actions.

- (1) **Not wearing respirators as required.** Respirator is one of the most important protective tools for rescue crew when conducting underground mine rescue. It can guarantee not only the rescuers' work when rescuing trapped people, but can also be the important barrier for rescuers themselves. It can be found by analysis that not wearing respirators as required have three specific forms: not wearing respirators when rescuing (16.9%), talking through respirator in the underground rescue (12.3%), removing the respirator without authorization (10.7%).
- (2) **Not following the gas detection requirements.** Usually when an accident occurs in the mine, it will affect the normal operation of the ventilation system, and local underground harmful gases will exceed their normal levels because of gas explosion or fire. If rescuers work underground without proper gas detection, this may cause a second explosion or other injuries, which can lead to further accidents. There are two main concrete manifestations by statistics: not detecting gas in ambulance space before working (13.9%), not detecting underground gas components dynamically as required (7.7%).
- (3) **Poor abilities of the ambulance crew.** It has multiple forms, embodied in the lack of mine rescue common sense, can't start rescue work expertly, not skilled in using rescue equipment, significant blunt errors due to nervousness of emergency, etc. Since rescuer is one of the most important participants in mine rescue, their ability directly influences the smooth and orderly conduct. There are two main concrete manifestations by statistics: unable to carry out self and mutual aid in emergency because they don't know how to use rescue equipment, not carrying rescue equipment like resuscitator. Among

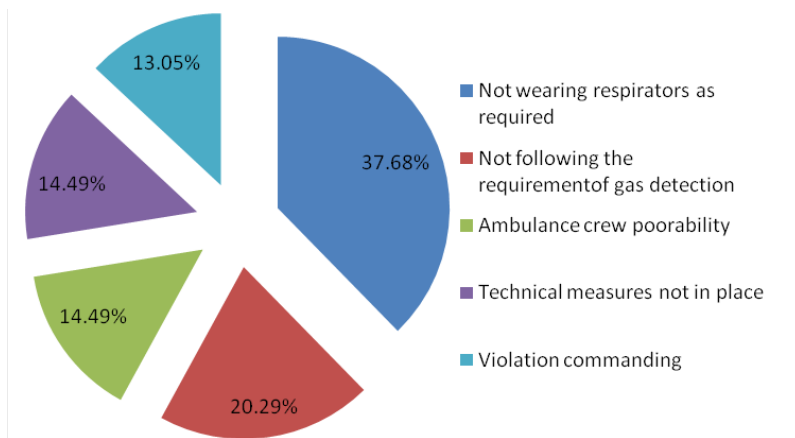

Figure 2. Proportion of different direct unsafe acts (The figures in picture are percentages)

these accidents, four of them (6.2%) happened because the rescuers could not carry out self and mutual aid in emergency and 6 accidents (9.2%) happened because the rescuers did not carry rescue equipment like resuscitator.

- (4) **Technical measures not in place.** Technical measures in mine rescue will directly affect the effectiveness of the rescue operation. Rescue in coal mine accidents is relatively complex and the risk is relatively high. Specific circumstances of different accident types and different environmental factors often lead to different levels of complexity. Therefore, making practical technical measures is vital. There are two main concrete manifestations by statistics: taking wrong coal mine rescue measures when the underground situation is unclear, not making safety rescue and protection measures by rule. The former led to 5 accidents making up 7.7% of the total samples.
- (5) **Violation of commanding.** It is for the commanders in coal mine rescue. After the accident, disaster relief command system must be set up immediately to take charge of the site guidance and scheduling according to "mine rescue procedures". Command system is the instruction giver of a mine rescue team, whose decision and command have direct impact on mine rescue team's action. Violation of commanding can lead to the occurrence of coal mine rescue accidents, or cause disorder and affect the mine rescue process. There are two main concrete manifestation by statistics: forcing rescuers to break into the pit with unknown details, forcing rescuers to work with the awareness of bad rescue condition. Among them, the former caused 6 accidents (9.2%) and the latter caused 4 accidents (6.2%).

Figure 2 shows that there is a big difference in the proportion between 5 unsafe acts of coal mine rescue accidents. Not wearing respirators as required accounts for the largest proportion for 37.68%, and not following the gas detection requirements comes the second, which accounts for 20.29%. The poor ability of the ambulance crew and technical measures not in place accounts for third at 14.49%. The last one is violation of commanding whose proportion is 13.04%. The first two has a larger proportion, as their sum is 57.97%, more than half. Therefore, in the five categories of direct unsafe acts, the focus of prevention and control should be on not wearing respirators as required and not following the gas detection requirements. It can greatly reduce the rate of mine rescue accidents from occurring if these two factors can be controlled well.

Among the specific direct unsafe acts, there are 6 factors in the front rank: not wearing respirators as required (15.94%), not detecting gas in ambulance space before working (13.04%), talking through respirator (11.59%), removing the respirator without authorization (10.14%), not carrying rescue equipment like resuscitator (9.2%) and forcing rescuers to break into the pit with unknown details (9.2%). The sum of six direct unsafe acts of coal mine rescue accidents accounts for 69.11% of all samples. So, these six factors are the main points of controlling concrete behaviors to effectively prevent coal mine rescue accidents.

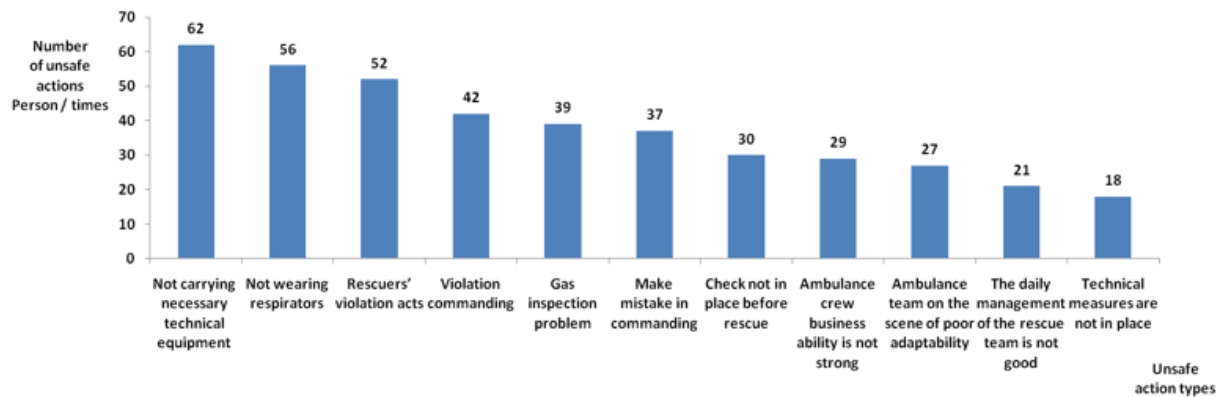

Figure 3. Distribution of different types of unsafe acts

DISCUSSION

Statistics of unsafe acts in this section are one-time acts in every coal mine rescue accident. This means that these are all unsafe acts relevant to the accident. All direct unsafe acts and relevant unsafe acts that lead to an accident are contained.

In order to facilitate the analysis of coal mine rescue accidents, we need to do some induction and consolidation. On the basis of reading abundant coal mine accident cases, using the statistical methods in the last section, related unsafe acts of coal mine rescue accidents are divided into 11 categories: not wearing respirators as required, not carrying necessary technical equipment, not detecting gas as required, poor ability of rescuers, technical measures not in place, pro-examination not in place, violation of commanding, daily management of rescue team not in place, rescuers' acts of violation, poor emergency capability, commanding error. These unsafe acts can be subdivided into 72 categories, which cannot be enumerated due to limited space.

Figure 3 shows that there is a frequency distribution among these types: (1) not carrying necessary technical equipment appears most with 62 people / time (14.87%), (2) not wearing respirators as required with 56 people / time (13.42%), (3) rescuers' acts of violation with 52 people / time (12.47%), (4) violation of commanding with 42 people / time (10.07%). These four types of unsafe acts are the highest-frequency ones with their sum equaling 50.83%, others appear relatively less.

This section calculates 19 categories of high frequency unsafe acts on the basis of 72 relevant unsafe acts in the last section, making it more targeted for controlling and preventing coal mine rescue accidents.

Statistics of high frequency unsafe acts can show which has higher frequency related to accidents. It provides some evidence for later safety training, as well as prevention and control of rescue accidents.

According to the above statistics, top 5 specific high-frequency unsafe acts are: not wearing respirators when rescuing, talking through respirator in the underground rescue process, not testing underground gas composition dynamically, not carrying spare respirator, no pro-examination of equipment. The 19 key statistics of high-frequency unsafe acts are the point of controlling and preventing coal mine rescue accidents, and the 5 high-frequency unsafe acts are the priority among the priorities listed in **Table 2**.

Table 2. High-frequency Unsafe Acts Causing Coal Mine Rescue Accident

No.	Specific Form	Number of Times
1	Not wearing respirators when rescuing	18
2	Talking by mouth breathing when downhole rescuing	17
3	Not detecting underground gas components dynamically as required	16
4	Not carrying spare respirator	14
5	No pro-examination of equipment	14
6	Not bringing disaster-phone	13
7	Going down to rescue with less than six people	13
8	Removing the respirator without authorization	12
9	Not carrying lighting equipment	11
10	Not detecting gas in ambulance space before working	11
11	Forcing rescuers to break into the pit with unknown details	11
12	Lack of on-site emergency response capacity, shouting after mouth appliance off	10
13	Taking off the mouth appliance when resting in disaster area	9
14	No inspection and inquiry about physical conditions of the ambulance crew before working	9
15	Untimely establishment of the repair headquarters, multiple and confusing commanding	9
16	Not letting someone check the gas in the closed downwind side	8
17	No checking one by one according to the fire zone unsealed plan	8
18	Forcing rescuers to work with the awareness of bad rescue condition	8
19	Working alone, unable to see the distress signal	8

CONCLUSION

Following conclusions have been drawn:

- (1) In order to make the acts that lead to coal mine rescue accidents clearer, we classified the concepts of unsafe acts; namely: direct unsafe acts, relevant unsafe acts and high-frequency unsafe acts.
- (2) There are five categories of direct unsafe acts which cause coal mine rescue accidents: not wearing respirators as required, not following the gas detection requirements, the poor abilities of the ambulance crew, technical measures not in place, and the violation of commanding.
- (3) There is a big difference in the proportion between 5 direct unsafe acts of coal mine rescue accidents. Not wearing respirators as required accounts for the largest proportion. Not following the gas detection requirements comes the second. Poor abilities of the ambulance crew and technical measures not in place tie for third, and the last one is the violation of commanding. The first two has a larger proportion, as their sum is 57.97%, more than half.
- (4) Out of all relevant unsafe acts, nineteen categories of high-frequency unsafe acts are statistically relevant, and 5 types are well-marked due to their higher frequency: not wearing respirators when rescuing, talking through respirator in the underground rescue process, not testing underground gas composition dynamically, not carrying a spare respirator, no pro-examination of equipment.
- (5) All results can be used for education.

ACKNOWLEDGEMENT

This paper is supported by National Natural Science Foundation of China – Study on the improvement of safety culture concept, elements and quantitative measurement method (Project number: 51504260).

REFERENCES

- Donahue, A. K., & Joyce, P. G. (2001). A Framework for Analyzing Emergency Management with an Application to Federal Budgeting. *Public Administration Review*, 61(6), 728-740. doi:10.1111/0033-3352.00143
- Dong, D., & Liu, J. (2006). Status and Development of China Mine Rescue Technology and Equipment. *Safety in Coal Mines*, 10, 62-65. doi:10.3969/j.issn.1003-496X.2006.10.022
- Hoetmer, G. J. (1991). *Emergency Management: Principles and Practice for Local Government*. Washington D. C.: International City Management Association
- Ikeda, Y., Beroggi, G. E. G., & Wallace, W. A. (1998). Supporting Multi-group Emergency Management with Multimedia. *Safety Science*, 30(1-2), 223-234. doi:10.1016/S0925-7535(98)00038-1
- Kong, Q. (2009). Thinking about Coal Mine Rescue Work. *Management & Technology of SME*, 5, 263-264. doi:10.3969/j.issn.1673-1069.2009.13.242
- Li, S. (2007). Discussion about Strengthening the Construction of Mine Rescue Team. *China Coal*, 1, 53-54. doi:10.3969/j.issn.1006-530X.2007.01.020
- Li, X., & Hu, J. (2005). Research and Application of Coal Mine Emergency Rescue Technology. *Coal Engineering*, 4, 62-64. doi:10.3969/j.issn.1671-0959.2005.04.025
- Papamichailh, K. N., & French, S. (2005). Design and Evaluation of an Intelligent Decision Support System for Nuclear Emergencies. *Decision Support Systems*, 41(1), 84-111. doi:10.1016/j.dss.2004.04.014
- Trainor, J. E. (2004). *Searching for a System: Multi-organizational Coordination in the September 11th Trade Center Search and Rescue Response*, master thesis.
- Wang, L., & Ma, S. (2004). Changing Ideas to Improve the Mine Rescue Service. *Safety in Coal Mines*, 9, 48-49. doi:10.3969/j.issn.1003-496X.2004.09.019
- Wybo, J. L., & Kowalski, K. M. (1998). Command Centers and Emergency Management Support. *Safety Science*, (30), 131-138.

<http://www.ejmste.com>



For print copies of this issue or articles please send an e-mail to:

print@modestum.co.uk



OPEN ACCESS

EURASIA Journal of Mathematics Science and Technology Education
ISSN: 1305-8223 (online) 1305-8215 (print)
2017 13(9):6211-6229
DOI: 10.12973/eurasia.2017.01060a



Mathematics, Technology and Learning: How to Align These Variables in Order to Explain Anxiety Towards Mathematics and Attitude Towards the Use of Technology for Learning Mathematics

Lizzeth Navarro-Ibarra

Mathematics Department, Instituto Tecnológico de Sonora, MEXICO

Arturo García-Santillán

UCC Business School, Universidad Cristóbal Colón, MEXICO

Omar Cuevas-Salazar

Mathematics Department, Instituto Tecnológico de Sonora, MEXICO

Julio Ansaldo-Leyva

Mathematics Department, Instituto Tecnológico de Sonora, MEXICO

Received 3 April 2017 • Revised 26 June 2017 • Accepted 12 August 2017

ABSTRACT

The aim of study is determining the set of variables which explain a student anxiety towards mathematics, as well as the student attitude towards the use of technology in PLM. To do this, the RMARS and MTAS scales were used. The instruments were applied to 522 undergraduate students at ITSON. The statistical procedure was EFA. The results obtained for the RMARS scale are: Bartlett's Test of Sphericity with KMO (0.689), χ^2 of 603.529 with 3 *df* and sig. 0.000 $p < 0.00$, MSA Measure of Sampling Adequacy all more than > 0.5 , with an eigenvalue (2.219) which explains the 73.955 % of the total variance. In the MTAS Scale, Bartlett's Test of Sphericity obtains a KMO value (0.678), χ^2 of 427.405 with 10 *df* and sig. 0.000 with MSA values more than > 0.5 in all cases, indicating that the variables of the MTAS Scale allow for establishing students' attitude towards mathematics and towards learning it using technology. The empirical evidence obtained allows us to believe that the use of technology may be a variable influencing students' attitude towards the process of teaching-learning mathematics measured using ICT, and that anxiety over mathematics may be a factor which determines this attitude.

Keywords: anxiety, attitude, mathematics, technology, students

BACKGROUND

The Eurydice network in Europe, made up of 31 countries, analyzes the situation of teaching mathematics at the primary and secondary school levels. Here the results of the international studies of the Program for International Student Assessment (PISA) and the Trends in International Mathematics and Science Study (TIMSS) show that a large percentage of students do not achieve the expected level of mathematical competence. However, fewer than half of the European countries have carried out studies or have reported the causes of these deficiencies in mathematics. Those countries that have researched the low levels of performance report factors which influence

© **Authors.** Terms and conditions of Creative Commons Attribution 4.0 International (CC BY 4.0) apply.

Correspondence: Arturo García-Santillán, *UCC Business School, Carr. Veracruz-Medellín s/n, Veracruz, Boca del Río, México.*

✉ agarcias@ucc.mx

State of the literature

- According to various investigations, students at all academic levels constantly say that mathematics is their most difficult subject. This causes student's high levels of anxiety and a negative attitude which obstructs acquiring knowledge when studying mathematics.
- Mathematical anxiety has been defined by various authors as a state of uneasiness which is caused by all of the activities which make up the teaching-learning process in the area of mathematics, even in the subject and courses themselves. Students manifest their anxiety by means of frustration, stress, fear, apprehension, aversion and concern. Besides these, other factors which influence student anxiety have been found, such as the student's personality, intellectual aspects and even environmental factors.

Contribution of this paper to the literature

- Richardson and Suinn (1972) carried out their seminal studies, and Pierce, Stacey and Barkatsas (2007) developed scales for measuring the level of anxiety towards mathematics and the attitude towards the use of technology in the teaching-learning process of mathematics. Since then, several empirical studies have been developed: García-Santillán, Escalera-Chávez and Córdova-Rangel (2012), García-Santillán, Escalera-Chávez, Camarena-Gallardo, García-Díaz Mirón (2012), García-Santillán, Flores-Serrano, López-Morales and Ríos-Álvarez, (2014), García-Santillán, Escalera-Chávez, Moreno-García, Santana-Villegas, (2015) and García-Santillán, Ortega-Ridaura and Moreno-García (2016). The results of these studies have indicated that university undergraduates, both men and women, experience anxiety over mathematics.
- Anxiety is based on the feelings of frustration that arise when the students try to solve a mathematical problem. The mere fact that they do not feel self-confident leads to their not being able to visualize the problem clearly and thus they feel stress during the process.
- Another point which must be mentioned is gender-based differences of anxiety towards mathematics. It has been determined that females have higher levels of anxiety than their male counterparts.

this, such as the years of schooling of parents, the lack of educational resources and help at home, the intrinsic lack of motivation of the student and under-qualified teachers (Eurydice, 2011).

In Latin America and the Caribbean, Valverde and Näslund-Hadley (2010) carried out studies on the state of education of mathematics and natural science for preschool, primary and secondary levels using data from standardized international tests including the Second Regional Comparative and Explanatory Study (SRCES), TIMSS and PISA as well as the results of the Caribbean Examination Council (CSEC). The research shows that the average levels of knowledge and skill in mathematics and in important areas of natural science are below the goals established by local educational policies and notably below the performance of students in eastern Asia and the industrialized countries which make up the Organization for Economic Co-operation and Development (OECD). According to this study, there are multiple causes: weak programs, deficient learning materials, lack of ability of teachers, memorization of routine computational operations and mechanical reproduction of concepts (Cabrol & Székely, 2012).

The Organization for Economic Co-operation and Development (OECD) presented an analysis of the results of PISA in the evaluation of mathematics in Mexico where 15-year-old students obtained 408 points in 2015, an increase of 23 points over PISA 2003, which was the largest increase among OECD countries. Additionally, the majority coincide with the decrease in the percentage of students at the basic level of achievement in mathematics established in the study of 66% in 2003 to 57% in 2015. However, the scores of Mexican students are 82 points below the average of 490 for countries in the OECD, which is the equivalent of approximately two years of teaching. Moreover, less than 1% of 15-year-old Mexican students achieved the best performance in mathematics compared to 10.7% of the students of the countries which make up the OECD (Organization for Economic Co-operation and Development, 2016).

The Mexican Ministry of Public Education (2014) carries out a standardized test for upper secondary education called Evaluación Nacional del Logro Académico en Centros Escolares (National Evaluation of Academic Achievement in Schools) (ENLACE) which evaluates basic competence in the fields of communication (reading

comprehension) and mathematics. This is an annual exam first given in 2008 in which student's achievements are classified as insufficient, elementary, good and excellent. In 2008 46.54% of the students were placed in the category of insufficient while in 2014 only 26.60% were in this lowest level, an improvement of 19.94%. The category of elementary achievement decreased 3.76% and the students with results which were considered good increased by 7.76% over the same period. The increase in the percentage of students who received an excellent grade from 3.43% in 2008 to 19.38% in 2014 was noteworthy.

While the results of ENLACE are promising, Santiago, McGregor, Nusche, Ravela and Toledo (2012) suggest an in-depth study be made of the impact of the test on schools and classes. With sciences such as Mathematics, besides the difficulty arising due to the differences between the ways it is taught and learned, this knowledge for many students represents knowledge which does not appeal to them; they reject it: they fear it and even have doubts about their ability to learn it as expressed by Rouquette and Suárez (2013).

The results of the various standardized tests (TIMSS, PISA, ENLACE) expose students' deficiencies in the area of Mathematics. This situation reflects the academic deficiencies of students when entering the university. It is for this reason that the Technological Institute of Sonora included in its academic agenda the development of this study.

In the OCDE report of 2009 in which the theme is "21st Century Skills and Competences for New Millennium Learners in OECD Countries" it is pointed out that nowadays young people use new forms of socialization and acquisition of social capital to a large extent using ICT (Information and Communication Technology).

To this respect Coll (2009) has suggested as an alternative solution for learning Mathematics, changing the traditional focus of teaching for methods using ICT as instruments which transform the cognitive processes, taking advantage of the potential of technology to create new forms of teaching and learning. While today the importance of using ICT in upper secondary education is acknowledged, there are factors which have prevented integrating it into the system.

However, Rouquette and Suárez's (2013) statements in relation to the student's feeling of rejection and fear of mathematics, as well Coll (2009) who points out as a solution to counteract the low performance in mathematics the use of ICT, allow us justify the following questions, objectives and hypotheses for this study.

Question 1: What is the set of latent variables that explain the student's level of anxiety towards mathematics?

Question 2: What is the set of variables that allow knowing the student's perception towards the use of technology in the teaching-learning process of mathematics?

Objective 1: To determine the set of variables that explain the student's level of anxiety towards mathematics.

Objective 2: To determine the set of variables that explain the attitude of the student to the use of technology in the process of teaching mathematics.

H₁: There is a set of variables that explain the student's level of anxiety towards mathematics.

H₂: There is a set of variables that explain the student's attitude towards the use of technology in the process of learning mathematics.

As a part of the initial approach, the variables involved in the problem were identified and placed within theoretical and empirical reality. Said variables are: Anxiety towards mathematics, attitude towards technology as a measure of the process of teaching-learning mathematics, from which the following theoretical-conceptual model has been established.

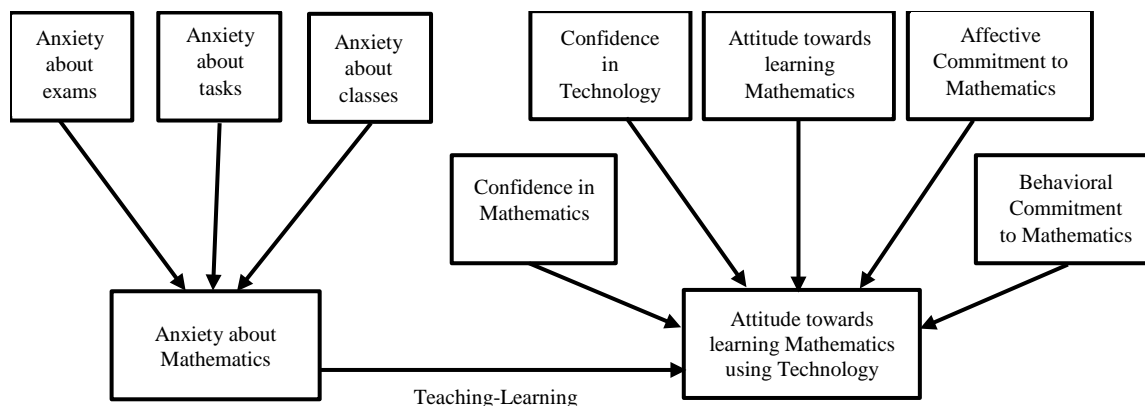

Figure 1. Preliminary Model of ATM* and attitude towards the use of technology in PEAM**

*ATM: Anxiety towards Mathematics

**PEAM: Process of teaching-learning Mathematics

Source: own

REVIEW OF LITERATURE

First, anxiety towards mathematics was measured in order to make a diagnosis and offer treatment for countering it. The instrument called MARS (Mathematics Anxiety Rating Scale) was developed by Richardson and Suinn (1972) and consisted of 98 items which made up one general factor. Various versions based on this instrument have arisen in which the number of items has been reduced and two or three factors have been established. One of the original authors even presented a version consisting of 30 items which he called MARS30-brief (Suinn and Winston, 2003). This abbreviated version is considered comparable to the original scale, reporting a Cronbach's Alpha score of 0.96 and a level of reliability of a test-retest of 0.90.

A 25-item version was developed by Alexander and Martray (1989). The name of this instrument is RMARS (Revised Mathematics Anxiety Rating Scale) and consists of three dimensions for measuring students' anxiety towards mathematics. A sub-scale measures anxiety due to exams in mathematics by means of items which describe students' reactions to situations which involve evaluations of math. Another sub-scale measures anxiety towards math tasks and this is measured by the anxiety towards basic activities such as multiplication and division. A third sub-scale measures the anxiety towards math class and is developed to measure students' reactions to being in math class. The internal reliability score is 0.96 and reliability on test-retest is 0.90 in a study carried out with 517 students.

There are various other scales developed to measure students' attitudes towards mathematics, such as those made by Fennema and Sherman (1976) and more recently the scale of Muñoz and Mato (2007, 2008). Various empirical studies have been made using these scales (García-Santillán, Flores-Serrano, López-Morales and Ríos-Álvarez, 2014; García-Santillán, Escalera-Chávez, Moreno-García, Santana-Villegas, 2015).

In turn, scales have been developed which not only measure students' attitude towards mathematics, but also towards the use of technology for learning mathematics. One of these instruments is Galbraith and Haines' scale (1998) which consists of 48 items and six subscales. Another is Pierce, Stacey and Barkatsas' scale (2007) with 20 items and five sub-scales, aimed at measuring students' attitudes towards learning mathematics using technology. Studies have been made based on these scales such as Gómez-Chacón (2010) which explores these constructs with additional techniques such as observations and interviews.

Similarly, there is other empirical evidence from research which seeks to determine the variables which intervene in students' attitudes towards mathematics and learning mathematics using technology such as studies

made by García-Santillán, Escalera-Chávez and Córdova-Rangel (2012), García-Santillán, Escalera-Chávez, Camarena-Gallardo, García-Díaz Mirón (2012), García-Santillán, Ortega-Ridaura and Moreno-García (2016).

Based on the analysis and discussion in literature which explains the phenomenon of this study, the construct of the causal theoretical model, which is shown in Figure 2, is justified.

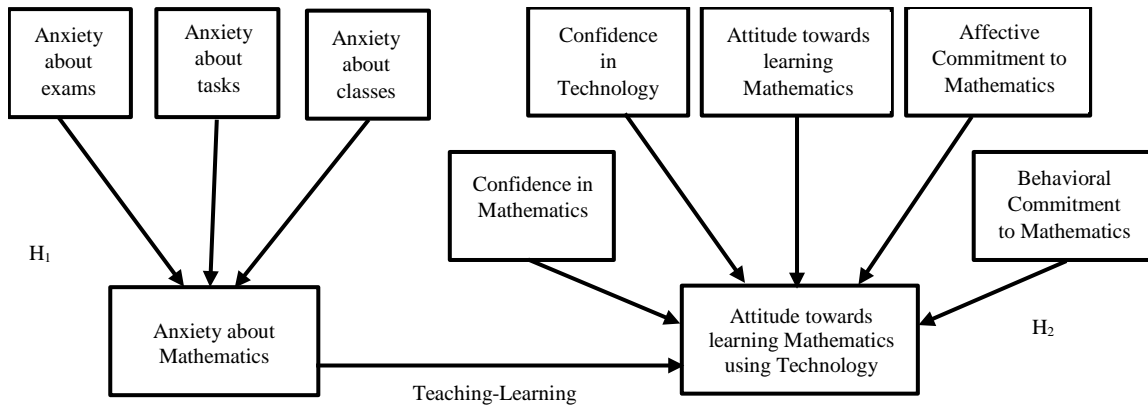

Figure 2. Definitive theoretical model of Anxiety towards Mathematics* and Attitude towards Technology in PEAM** of mathematics

*ATM: Anxiety towards Mathematics

**PEAM: Process of teaching-learning Mathematics

Source: own

DESIGN AND METHOD

This is a non-experimental study since the independent variables are not manipulated and therefore the effects (dependent variables) will not be conditioned towards a predetermined result. It is a cross-sectional study since the data collection in the application of the instrument and the analysis and interpretation are not carried out over time. It is an explicative study because it is our desire to learn the level of anxiety of students towards mathematics and their attitude towards the use of technology in the teaching-learning process of mathematics.

Instruments

Our study used two instruments, the first developed by Alexander and Martray (1989) with the acronym RMARS meaning a "Revised Mathematics Anxiety Rating Scale," and whose seminal source is the 98-factor scale of Richardson and Suinn (1972). The second survey is the one built by Pierce, Stacey and Barkatsas (2007), the "Mathematics and Technology Attitudes Scale" with the acronym MTAS.

Based on the MARS scale of Richardson and Suinn (1972), other versions were designed where the number of questions is reduced and the number of factors is increased. A revision of the scale was done by Alexander and Martray (1989), where the instrument was reduced to 25 affirmations that integrate, in turn, three dimensions. This version of the scale is called "Revised Mathematics Rating Scale" (RMARS) and was applied in 517 students where it obtained an internal reliability of 0.96 and a test-retest reliability of 0.90.

One of the dimensions of the RMARS scale is to measure anxiety about math exams by exposing situations that describe students' reactions to an assessment activity. The second dimension is about numerical tasks, where statements about reactions to basic multiplication and division activities are described. The third dimension is to measure anxiety towards the subject of mathematics and poses situations about the student's reaction when he is in a mathematics class. Table 1 presents the items that make up the scale dimensions.

Table 1. Factors of the RMARS scale of anxiety towards mathematics

Indicators	Definition	Code/Items
1-15	Anxiety towards math tests	RMARS 1 through RMARS 15
16-20	Anxiety towards numerical tasks	RMARS 16 through RMARS20
21-25	Anxiety towards math course	RMARS 21 through RMARS25

Source: taken from Alexander and Martray (1989)

The scale used is a Likert type scale which presents values ranging from 1 to 5, in which 1 is not at all and 5 is very much: N= not at all; P=a little; R=Normal; M=a lot; D=very much.

Just as there are scales to measure anxiety towards mathematics, instruments have also been developed to measure student attitudes toward learning mathematics with technology. One of these instruments is the scale of Pierce, Stacey and Barkatsas (2007) with 20 items and five subscales, aimed at measuring students' attitude toward learning mathematics with technology. The dimensions that comprise this scale are confidence in mathematics, confidence with technology, attitude toward learning math with technology, affective commitment and behavioral commitment. **Table 2** shows the items that make up each dimension of the scale.

Table 2. Factors of the MTAS scale of attitude towards mathematics and technology

Indicators	Definition	Codes/Items
1-4	Commitment to behavior	MTAS1 al MTAS4
5-8	Confidence in technology	MTAS5 al MTAS8
9-12	Confidence in mathematics	MTAS9 al MTAS12
13-16	Affective commitment	MTAS13 al MTAS16
17-20	Attitude towards learning mathematics using technology	MTAS17 al MTAS20

Source: taken from Pierce, Stacey and Barkatsas (2007)

The scale used was a Likert type scale. For the first four items, the options for answers are: CN=Almost never, AV=At times, MV= half of the time, U=Usually and CS=Almost never. For items 5 through 20, the options for answers are: MDS=Strongly disagree, ED=Disagree greatly, NS=Disagree, DE=Agree and MD=Strongly agree.

The assigned values for the answers are from one to five, where one is for *almost never* or *very much in disagreement*, up to five in the option *almost always* or *very much in agreement*.

This instrument was applied by Pierce et al. (2007) to 350 students from six schools. Principal component analysis indicated that the five factors each with an eigenvalue greater than one explained 65% of the variance, where almost 26% was attributed to the first factor. The reliability analysis with Cronbach's alpha gave values between 0.65 to 0.89 which indicates the strength in the internal consistency of each subscale.

Participants

The study was carried out at the Technological Institute of Sonora, which is a university located in the south of the State of Sonora. This program offers undergraduate and postgraduate programs with a student population of 16,442 students in the 2015-2016 school years (Instituto Tecnológico de Sonora, 2016).

The research included 522 undergraduate students enrolled in a mathematics subject during the August-December 2016 semester. This sample is representative of students taking math courses at the university.

The sample was a convenience sample, as the scale was applied to students in a mathematics class where the teacher yielded class time for this purpose. Student participation was anonymous and voluntary. The instruments were responded on paper in the presence of the interviewer and within university facilities.

The composition of the population which was the object of the study is as follows: 33% women, 67% men; 22% in bachelor's degree programs in economic administrative science and 78% in engineering. 58% of the students were in their first semester, 23% in the third semester, 8% in the fifth semester and 11% were distributed among the second and eleventh semesters. Average age of the women was 18 years old. 17% work at least 10 hours per week. Among the male students, the average age was 18, and 27% work at least 10 hours per week. 75% of the students mentioned having sufficient economic funds for their studies, 13% mentioned they were insufficient, and 12% indicated they were excellent.

Procedure

The theoretical criteria established that the hypotheses are the invariant type: Null Hypothesis: $H_0: \rho = 0$ indicating that there is no correlation and $H_1: \rho \neq 0$ which indicates that there is a correlation.

Therefore, for measuring the data obtained in the field and the contrast of hypotheses H_1 and H_2 , the multivariate technique of exploratory factor analysis was used with extraction of components, based on the following criteria: validation of the test using Cronbach's alpha score, belonging to the model to Bartlett's test of Sphericity with Kaiser KMO, the χ^2 with gl and 0.01 significance, the measure of sampling adequacy by variable (MSA), factor loading of 0.70. The criteria of decision for rejecting H_0 in all cases is: Reject H_0 if χ^2 calc $>$ χ^2 tables. To this end, we follow the procedure which García-Santillán *et al* (2012, 2013, 2014 and 2017) recently carried out in some studies and which is presented in the following data matrix in **Table 3**.

Table 3. Matrix of students' data

Students	Variables
1	$X_{11}, X_{12}, \dots, X_{1p}$
2	$X_{21}, X_{22}, \dots, X_{2p}$
...	...
522	$X_{n1}, X_{n2}, \dots, X_{np}$

where $X_{11}, X_{12}, \dots, X_{n1}$ is given by the following equations: $X_1 = a_{11}F_1 + a_{12}F_2 + \dots + a_{1k}F_k + u_1$; $X_2 = a_{21}F_1 + a_{22}F_2 + \dots + a_{2k}F_k + u_2$; ...; $X_p = a_{p1}F_1 + a_{p2}F_2 + \dots + a_{pk}F_k + u_p$.

Source: own

Therefore, the expression is the following:

$$X = Af + u \tilde{U}X = FA' + U \tag{1}$$

where

Data matrix	Factorial loading matrix	Factorial matrix
$X = \begin{pmatrix} x_1 \\ x_2 \\ \vdots \\ x_p \end{pmatrix}, f = \begin{pmatrix} F_1 \\ F_2 \\ \vdots \\ F_3 \end{pmatrix}, u = \begin{pmatrix} u_1 \\ u_2 \\ \vdots \\ u_3 \end{pmatrix}$	$A = \begin{pmatrix} a_{11} & a_{12} & \dots & a_{1k} \\ a_{21} & a_{22} & \dots & a_{2k} \\ \vdots & \vdots & \ddots & \vdots \\ a_{p1} & a_{p2} & \dots & a_{pk} \end{pmatrix}$	$F = \begin{pmatrix} f_{11} & f_{12} & \dots & f_{1k} \\ f_{21} & f_{22} & \dots & f_{2k} \\ \vdots & \vdots & \ddots & \vdots \\ f_{p1} & f_{p2} & \dots & f_{pk} \end{pmatrix}$

with a variance equal to:

$$\text{Var}(X_i) = \sum_{j=1}^k a_{ij}^2 + \Psi_i = h_i^2 + \Psi_i; i = 1, 2, \dots, p \tag{2}$$

$$h_i^2 = \text{Var} \left(\sum_{j=1}^k a_{ij}F_j \right) \dots y \dots \Psi_i = \text{Var}(u_i) \tag{3}$$

This equation corresponds to the communalities and the specificity of the X_i variable. So, the variance of each variable is made up of two parts:

- a) Its h_i^2 communalities representing the variance explained by common factors and
- b) The specificity Ψ_i which corresponds to the specific variance of each variable.

Thus calculating:

$$\text{Cov}(X_i, X_l) = \text{Cov}\left(\sum_{j=1}^k a_{ij}F_j, \sum_{j=1}^k a_{lj}F_j\right) = \sum_{j=1}^k a_{ij}a_{lj}, \forall i \neq l \tag{4}$$

Bartlett’s test of sphericity is obtained with the transformation of the correlation of the matrix of determinants and is calculated with the following equation:

$$d_R = -\left[n - 1 - \frac{1}{6}(2p + 5) \ln|R|\right] = -\left[n - \frac{2p + 11}{6}\right] \sum_{j=1}^p \log(\lambda_j) \tag{5}$$

where n = size of the sample, \ln = natural logarithm, λ_j ($j = 1, 2, \dots, p$) values which belong to R , R = Correlation matrix.

In order to compare the magnitude of the correlation of the coefficients observed with the magnitude of the partial correlation of the coefficients, a measure of the sampling adequacy (KMO) developed by Kaiser, Meyer and Olkin was carried out, as well as calculating the measure of sampling adequacy of each variable (MSA), where only the coefficients of the variable to be evaluated were included. The two measurements are given for the expressions:

$$\text{KMO} = \frac{\sum_{j \neq i} \sum_{i \neq j} r_{ij}^2}{\sum_{j \neq i} \sum_{i \neq j} r_{ij}^2 + \sum_{j \neq i} \sum_{i \neq j} r_{ij(p)}^2}, \text{MSA} = \frac{\sum_{i^1 j} r_{ij}^2}{\sum_{i^1 j} r_{ij}^2 + \sum_{i^1 j} r_{ij(p)}^2}; i = 1, 2, \dots, p \tag{6}$$

where $r_{ij}(p)$ is the reason of the partial correlation of the X_i, Y, X_j variables in all cases. Next, we present the empirical results obtained.

DATA ANALYSIS

First, it is necessary to evaluate the internal consistency of the instruments used in the study, which are the Alexander and Martray test (1989) and the Piercy, Stacey and Barkatsas test (2007). To this end, Cronbach’s alpha score (α) was used. This coefficient of Cronbach’s alpha score represents the square of the coefficient of the correlation which measures the consistency of the items using the average of all of the correlations among all of the questions. The closer it is to 1, the better the reliability. Cronbach’s alpha scores of 0.80 or more are considered acceptable. For this reason, Cronbach’s alpha score may be defined in function of the number of items and the average of the correlations among these items.

$$\alpha = \frac{N\bar{r}}{1 + (N - 1)\bar{r}}$$

where N =the number of items or latent variables; r = the average of correlations among items.

RESULTS

The empirical results are presented for each scale by individual constructs of Anxiety towards Mathematics and Attitude towards the process of teaching-learning mathematics using technology.

Table 4 describes the results of the reliability analysis for the survey “Revised Mathematics Anxiety Rating Scale” for the construct of Anxiety towards Mathematics.

Table 4. Reliability test

Concept	Cases	%	α
Valid cases	522	100.0	$\alpha = 0.941$
Excluded (a)	0	0.0	25 factors
Total	522	100.0	
Dimensions	ANXTASKM		$\alpha = 0.640$ with 3 dimensions
	ANXCOURM		
	ANXTESTM		

(a) Elimination based on all variables of the procedure

The results show an α of 0.941 for all items and grouped into three dimension the Alfa value is 0.640, which are acceptable, according to the theoretical statement exposed by Hair, Anderson, Tatham and Black (1999) with $\alpha > 0.6$. Based on this, we can say that the scale has the characteristics of internal consistency and reliability which are prerequisites for the validity of the instrument. Therefore, we now present the empirical evidence for the first construct as shown in **Figure 3**.

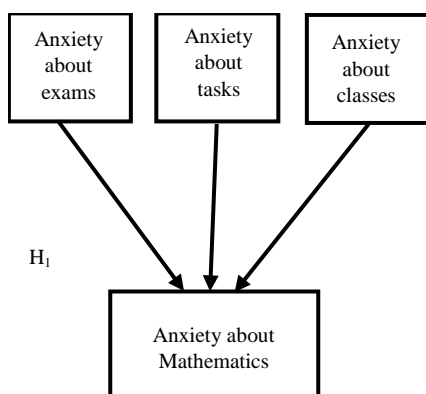

Figure 3. Construct of mathematical anxiety

Table 5 describes the results of the analysis of reliability of the survey, “Mathematics and Technology Attitudes Scale” for the construct of attitude towards mathematics and learning it using technology.

Table 5. Test of reliability

Concept	Cases	%	α
Valid cases	512	98.1	$\alpha = 0.839$
Excluded (a)	10	1.9	20 factors
Total	522	100.0	
Dimensions	BEHENGAM		$\alpha = 0.607$ with 5 dimensions
	AFFENGM		
	CONFTEC		
	ATTMATTE		
	CONFMAT		

(a) Elimination based on all variable of the procedure

The results show an α of 0.839 for all items and for groups of five dimensions the alpha is 0.607, which are acceptable, according to the theoretical statement exposed by Hair, Anderson, Tatham and Black (1999) with $\alpha > 0.6$. Based on this we can say that the scale has the characteristics of internal consistency and reliability which are

prerequisites for the validity of the instrument. Therefore, we now present the empirical evidence for the second construct, as shown in Figure 4.

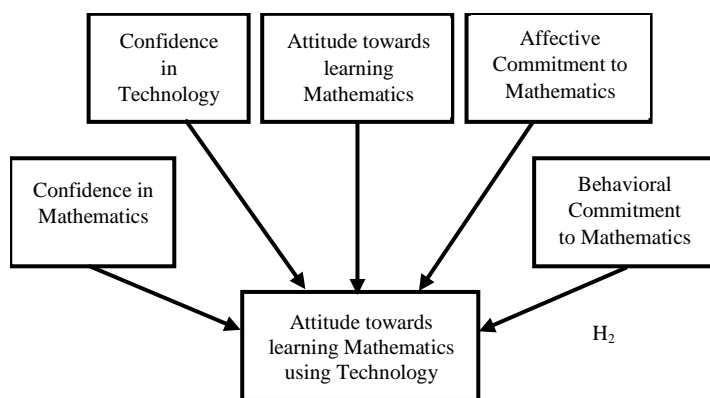

Figure 4. Construct of Attitude towards technology in teaching-learning mathematics
Source: own

RMARS Instruments

Regarding the question: what is the set of latent variables that allow explaining the level of anxiety of the student towards mathematics?, whose objective was to determine the set of latent variables that explain the level of anxiety of the student towards mathematics and the hypothesis that indicates, It was determined that there is a set of latent variables that explain the student's level of anxiety towards mathematics, the following evidence was obtained.

a) *Bartlett's test of Sphericity*

Before beginning the factorial analysis, we verified that this procedure was appropriate and that it would provide information which would explain the variables of the study. To this end Bartlett's test of Sphericity with KMO and Measure of Sampling Adequacy (MSA), were carried out in order to identify whether there was any correlation between the variables of the study and thus justify the selection of this technique.

Bartlett's test of Sphericity is a test which is applied in order to prove a null hypothesis which affirms that the matrix of correlations is a matrix of identity with a variation of zero to one. Small values indicate that the factorial analysis is not appropriate because the correlations between pairs of variable cannot be explained by other variables. If the KMO value is <0.5 this means that there is not a strong correlation between the variables and therefore factorial analysis cannot be used with the data shown in the study.

Table 6 shows the results of Bartlett's test of Sphericity, KMO, MSA, χ^2 , with significance $p < 0.01$. The value of χ^2 is 603.529 with 3 degrees freedom, which is high. The KMO Measurement is 0.689 and since it is higher than 0.5 a correlation exists between variables.

Table 6. KMO, MSA, χ^2 matrix correlation

Variable	MSA	KMO	Bartlett test of Sphericity (χ^2)
ANXTESTM	0.783		603.529
ANXTASKM	0.678	0.689	df 3
ANXCOURM	0.641		sig. 0.00

Source: own

The values in **Table 6** confirm that it is appropriate to carry out factorial analysis. Therefore the null hypothesis which expresses that there is no correlation between the variables is rejected. This indicates that the variables which make up the study allow for explaining the phenomenon and factorial analysis may be carried out.

b) *Measure of Sampling Adequacy (MSA)*

Table 7 shows the anti-image correlation matrix in which it may be seen that the MSA values are greater than 0.5, which shows that there is a strong relationship among variables and therefore it is appropriate to carry out factorial analysis.

Table 7. Anti-image correlation matrix

		ANXTESTM	ANXTASKM	ANXCOURM
Anti-image Co-variance	ANXTESTM	0.625	-0.095	-0.196
	ANXTASKM		0.485	-0.264
	ANXCOURM			0.428
Anti-image Correlation	ANXTESM	0.783^a	-0.173	-0.378
	ANXTASKM		0.678^a	-0.579
	ANXCOURM			0.641^a

^a Measure of sampling adequacy

The diagonal of the anti-image correlation matrix corresponds to the values of the measure of sampling adequacy (MSA) for each variable. The values in the diagonal of the matrix should be greater than 0.5 in order to confirm that the factorial model is appropriate for analyzing the data which was collected. On the diagonal the values are between 0.641^a and 0.783^a. This confirms that factorial analysis may be carried out in order to explain the phenomenon of the study.

Table 8 shows the correlations matrix. It may be observed that the values are >0.5 which indicates that the variable are all inter-correlated, establishing that factorial analysis may be carried out.

Table 8. Correlation matrix

		ANXTESM	ANXTASKM	ANXCOURM
Correlations	ANXTESTM	1.000		
	ANXTASKM	0.520	1.000	
	ANXCOURM	0.596	0.707	1.000

(a) Determinant = 0.313

As was described previously, with the transformation of the correlation matrix Bartlett's test of Sphericity is obtained as presented in **Table 6** by means of the equation 5:

$$d_R = - \left[n - 1 - \frac{1}{6}(2p + 5) \ln|R| \right] = - \left[n - \frac{2p + 11}{6} \right] \sum_{j=1}^p \log(\lambda_j)$$

c) *Matrix of components, communalities, eigenvalue and total variance*

Once it has been confirmed that factorial analysis is the correct technique for analyzing this data, evaluation of the factors and components may begin. **Table 9** shows the matrix of components, communalities, eigenvalue and total variance explained.

Table 9. Matrix of components, communalities, eigenvalue and total variance

	Component 1	Communalities
ANXTESTM	0.810	0.656
ANXTASKM	0.868	0.753
ANXCOURM	0.900	0.809
Eigenvalue	2.219	
Total variance	73.955 %	

Source: own

An eigenvalue greater than one (2.219) suggests the existence of a factor with a total explained variance of 73.955% of the total variation of the data. Similarly, in **Table 9** the load of the three factors which were calculated in the main extraction of the components is described. The three factors make up component one with a factorial load >0.5 for all of them. ANXCOURM (0.900) has the largest load; this corresponding to anxiety about Mathematics class, followed by ANXTASKM (0.868) and last ANXTESTM (0.810). With respect to the proportion of variance explained by the communalities, the following values may be observed: ANXCOURM (0.809) with the highest value, followed by ANXTASKM (0.753) and with the lowest value ANXTESTM (0.656).

MTAS Instrument

For the second question: What is the set of latent variables which allows knowing students' attitude towards the use of technology in the teaching-learning process of mathematics?, the following evidence was obtained:

a) *Bartlett's test of Sphericity*

Before beginning factorial analysis, we verified that this procedure was appropriate and that it would provide information which explained the variables of the study. To this end Bartlett's test of Sphericity was carried out with KMO and Measure of Sampling Adequacy (MSA). This was all done in order to identify whether there was a correlation among the variables of the study, thus justifying the selection of this technique.

Bartlett's test of Sphericity is a test which is made in order to prove the null hypothesis that affirms that the correlations matrix is an identity matrix with a variation of zero to one. Small values indicate that factorial analysis is not appropriate because the correlation between the pairs of variables cannot be explained by other variables. If the KMO value is <0.5 this means that there is not a strong correlation among the variables and therefore factorial analysis cannot be used with the data of the sample of the study.

Table 10 shows the results of Bartlett's test of Sphericity, KMO; MSA, χ^2 , with $p < 0.01$ significance. The χ^2 valued is 427.405 with 10 points of freedom, which is high. The KMO adequacy measurement is 0.678 and since it is higher than 0.5 that shows there a correlation does exist among variables.

Table 10. Correlation matrix-KMO, MSA, χ^2

Variable	MSA	KMO	Bartlett test of Sphericity (χ^2)
BEHENGAM	0.736		
CONFTEC	0.738		427.405
CONFMAT	0.656	0.678	df 10
AFFEENGAM	0.675		sig. 0.00
ATTMATTE	0.573		

Source: own

The values in **Table 10** confirm that it is appropriate to carry out factorial analysis, and for this reason, the null hypothesis which expresses that the variables are not correlated, is rejected. This indicates that the variables which make up the study allow for explaining the phenomenon, and factorial analysis may be carried out.

b) *Measure of Sampling Adequacy (MSA)*

Table 11 shows the anti-image matrix in which it can be seen that the MSA values are greater than 0.5, which shows that there is a strong relationship among variables and thus it is appropriate to carry out factorial analysis.

The correlation diagonal of the anti-image matrix corresponds to values measured using Measure of Sampling Adequacy (MSA) for each variable. The values on the diagonal of the matrix must be greater than 0.5 in order to confirm that the factorial model is appropriate for analyzing the data collected. On the diagonal, the values are between 0.573^a and 0.738^a which confirms that exploratory factorial analysis may be implemented in order to explain the phenomenon studied.

Table 11. Anti-image matrix

		BEHENGAM	CONFTEC	CONFMAT	AFFEENGM	ATTMATTE
Anti-image covariance	BEHENGAM	0.692	0.003	-0.225	-0.154	-0.023
	CONFTEC		0.967	-0.040	-0.040	-0.112
	CONFMAT			0.607	-0.253	0.069
	AFFEENGM				0.611	-0.179
	ATTMATTE					0.911
Anti-image correlation	BEHENGAM	0.736^a	0.004	-0.348	-0.236	-0.029
	CONFTEC		0.738^a	-0.052	-0.053	-0.119
	CONFMAT			0.656^a	-0.416	0.093
	AFFEENGM				0.675^a	-0.240
	ATTMATTE					0.573^a

^a Measure of Sampling Adequacy

Table 12 presents the correlation matrix. It can be observed that the values reflect correlation among variables and thus factorial analysis may be carried out.

Table 12. Correlation matrix

		BEHENGAM	CONFTEC	CONFMAT	AFFEENGM	ATTMATTE
Correlation	BEHENGAM	1.000				
	CONFTEC	0.074	1.000			
	CONFMAT	0.511	0.109	1.000		
	AFFEENGM	0.462	0.132	0.550	1.000	
	ATTMATTE	0.119	0.144	0.077	0.261	1.000

(a) Determinant = 0.431

As previously described, with the transformation of the correlation matrix we obtain Bartlett's test of Sphericity which was shown in **Table 10**.

c) *Matrix of components, communalities, eigenvalue and total variance*

Upon confirming that factorial analysis is the appropriate procedure to use in analyzing the data, we will follow up with the determination of the factors and components. In **Table 13** we may see the matrix of the components, communalities, eigenvalue as well as the total variance explained.

Table 13. Matrix of components, communalities, eigenvalue and total variance

	Component 1	Component 2	Comunalities
BEHENGAM	0.764		0.650
CONFTEC		0.694	0.556
CONFMAT	0.805		0.720
AFFEENGM	0.826		0.683
ATTMATTE		0.666	0.576
Eigenvalue	2.121	1.065	
Total variance	42.422%	21.296%	

Source: own

The eigenvalues are greater than one. The component 1 has an eigenvalue of 2.121 with a total variance explained of 42.422% and component 2 has an eigenvalue of 1.065 and a total variance explained of 21.296%. In turn, **Table 13** presents the load of the five factors obtained in the main extraction of the component method.

For component 1 the AFFEENGM (0.826) has the greatest load that refers to the affective commitment to mathematics, followed by CONFMAT (0.805) for the category confidence in mathematics. The third place is held by BEHENGAM (0.764), this corresponding to commitment of behavior in mathematics. The attitude towards learning math using technology is reflected in the variable ATTMATTE (0.364) and finally trusting technology with the variable CONFTEC (0.273).

For component 2, the variable CONFTEC (0.694) has the largest load. In second place is attitude towards learning mathematics using technology which is reflected in the ATTMATTE (0.666) variable.

The proportion of explained variance by means of the communalities indicates the following values: CONFMAT (0.720) with the greatest value, followed by the variables AFFEENGM (0.683), BEHENGAM (0.650), ATTMATTE (0.576) and with the lowest valued CONFTEC (0.556).

With these results it is now possible to draw the following conclusions based on the existing theory, as well as empirical evidence on which the study was based.

CONCLUSION

The data analysis allows us to begin with a discussion of the results of the study. Anxiety towards mathematics is found in students from different educational levels and it is necessary to carry out a broader study in order to establish strategies to attenuate this anxiety. Similarly, growing technology has made more digital resources available for the teaching-learning process. Therefore, determining students' attitudes towards the use of technology for learning mathematics has become an aspect which merits more attention.

The scales applied to students at the Instituto Tecnológico de Sonora presented appropriate indicators of internal consistence. Cronbach's alpha scores for all items of the RMARS scale (0.941) and for MTAS (0.839); Cronbach's alpha scores for RMARS (0.640) and for MTAS (0.607).

These kinds of scales have been implemented in various studies with favorable results when the object is searching for explanations and understanding levels of anxiety towards mathematics and students' attitudes towards using technology to learn mathematics. Studies have been carried out in various contexts and at various academic levels (Richardson and Suinn, 1972; Fennema and Sherman, 1976; Muñoz and Mato, 2007; Muñoz and Mato, 2008; Galbraith and Haines, 1998; Gómez-Chacón, 2010; García-Santillán, Flores-Serrano, López-Morales & Ríos-Álvarez, 2014; García-Santillán, Escalera-Chávez, Moreno-García & Santana-Villegas, 2015).

With respect to the values obtained with Bartlett's test of Sphericity with KMO (0.689 and 0.678), χ^2 with 3 degrees of freedom (603.529) for the RMARS scale and 10 degrees of freedom (427.405) for the MTAS scale. The significance was 0.000 in both cases, showing a significant result which allows for rejecting the null hypothesis. On

the RMARS scale the null hypothesis established the non-existence of a set of latent variables which explain the level of anxiety towards mathematics. Upon rejecting this hypothesis, we confirm the existence of a set of latent variables. In the same way, on the MTAS scale, upon rejecting the null hypothesis it can be affirmed that there is no set of latent variables which explain student's attitude towards the use of technology for learning mathematics, thus confirming the existence of a set of latent variables which explains said attitude. These tests validate the pertinence of carrying out exploratory factorial analysis.

With respect to anxiety, the results show great anxiety between mathematics classes and numerical tasks (0.707). Less anxiety is shown by students between mathematics class and exams (0.596) and between numerical tasks and exams (0.520). In turn, attitude presents greater correlation between affective commitment and confidence in mathematics (0.550), following the correlation between the commitment to behavior and confidence in mathematics (0.511). We find the correlation between the affective commitment and the commitment to behavior to be slightly lower (0.462).

In both scales the determinant was greater than 0.05 (0.313 and 0.431) which is the theoretical maximum desirable value because the closer the value of the determinant is to zero, the higher the correlations between variables under study. Even when the values of the determinants are not lower than the theoretical desirable value (<0.05), all of the variables correlate positively for both scales, which indicates the presence of a significant correlation in the set of variables under study of the constructs developed by Alexander and Martray (1989) and Pierce, Stacey and Barkatsas (2007).

The total variance explained for both scales is acceptable (73.955% and 63.718%) which indicates that Alexander and Martray's scale (1989) and Pierce, Stacey and Barrkatsas' scale (2007) are appropriate for explaining the level of students' anxiety towards mathematics and their attitude towards the use of technology for learning mathematics, respectably. This affirmation may only be made for university students within the Latin American context, specifically for the population where the scales were applied.

In the RMARS scale, the analysis by dimension indicates that a single component is formed that integrates the three dimensions, with 73.955% of the total variance explained. In turn, studies by Bowd and Brady (2002) and Baloglu and Zelhart (2007) show the formation of three factors with 73%, and 66.08% of the total variance explained, respectively, coinciding with Alexander and Martray (1989).

In the MTAS scale, the results show that the analysis by dimension is formed by two components with eigenvalue greater than one. In the study by Pierce et al. (2007) in the analysis of all the items, we had five components with a total explained variance of 65%, with almost 26% of the variance in the first component (confidence in mathematics). Similarly, Barkatsas, Kasimatis and Gialamas (2009) obtained five components with 67% of the total variance explained and the first component was confidence in mathematics with approximately 16% of the total variance explained.

In the present study, the total variance explained was 63.718% for the MTAS scale. The first component groups the commitment factors of behavior, confidence and affective commitment towards mathematics, with a total variance explained of 42.422%. The second component integrates the confidence factors in technology and attitude toward technology for learning mathematics, with a total variance explained of 21.296%.

In the first component, the affective commitment dimension in mathematics contributes the highest value (.826), followed by the confidence dimension in mathematics (.805) and behavioral commitment in mathematics (.764), in contrast to Pierce, et al. (2007) and Barkatsas et al. (2009) where the first component was confidence in mathematics.

The result has theoretical and practical implications from the following point of view:

The theoretical implications are based on research carried out by Alexander and Martray (1989) and Pierce, Stacey and Barkatsas (2007), for levels of anxiety towards mathematics and the attitude towards using technology in learning mathematics.

In Alexander and Martray's study (1989) called "*The Development of an Abbreviated Version of the Mathematics Anxiety Rating Scale*" it is reported that the scale designed allows for identifying the variables which cause anxiety towards mathematics. The variables which emerge are: anxiety towards exams, anxiety towards numerical tasks and anxiety towards mathematics courses. In their conclusions they affirm having proved that there is correspondence between the initial structure of the factors and the findings at the theoretical level.

The dimensions which have been analyzed are: anxiety towards exams and anxiety towards numerical tasks. Among the research which include these kinds of arguments are those of Rounds and Hendel (1980), Plake and Parquer (1982), Resnick, Viehe and Segal (1982), Alexander and Cobb (1984), Chiu and Henry (1990).

In the present study, high values of correlation are shown between mathematics courses and numerical tasks (0.707). The largest load is held by ANXCOURM (0.9000) which corresponds to anxiety towards the mathematics course, followed by ANXTASKM (0.868), and finally ANTESTM (0.810). With respect to the proportion of variance explained by communalities, the following values were observed: ANXCOURM (0.809) with the highest value, followed by ANXTASKM (0.753) and with the lowest value ANXTESTM (0.656). This data suggests that the population under study shows greater anxiety towards the mathematics course, followed by anxiety towards numerical tasks and finally towards exams.

In turn, attitude presents greater correlation between the affective commitment and confidence in mathematics (0.550). In the statistical analysis two components were determined. For component 1 the highest load is held by AFEEENG (0.826) which refers to the affective commitment to mathematics, followed by COMFMAT (0.805), confidence in mathematics. In the third place is BEHENGAM (0.764) which corresponds to the commitment to behavior in mathematics. For component 2 the highest load is held by CONFTEC (0.694). In second place we find the attitude towards learning mathematics using technology which is reflected in the variable ATTMATTE (0.666). The proportion of variance explained by means of communalities indicates the following values: COMFMAT (0.720) with the greatest value, then the variables AFEEENG (0.683), BEHENGAM (0.650), ATTMATTE (0.576) and with the lowest value CONFTEC (0.556).

The practical implications stemming from the results obtained in the present study may be used as a referent for establishing teaching strategies applicable in the context of students in Mexico, especially in the Northwest of the country, where this study was carried out. The strategies should be designed with the objective of reducing the aspects which are causing the students anxiety towards mathematics. At the same time, the same strategies may be used to gather information which helps understand students' behavior in the process of teaching-learning mathematics. It is important to take into account technology as a tool which may bring students closer to mathematics, providing self-confidence and facilitating algorithmic processes.

It is of utmost importance to take into account that the phenomenon of anxiety towards mathematics not only affects students with low academic performance, but also those students who have good academic performance in other subjects are affected. Therefore, actions to be carried out by educational institutions must seek to correct and also prevent anxiety towards mathematics.

The findings allow us to identify that the mathematics course dimension is what causes greater anxiety, followed by arithmetic operations and finally by exams. In addition, the attitude towards technology for the learning of mathematics has been influenced by the mathematical aspects. This will serve to propose an intervention strategy in ITSON where technology is used in such a way as to facilitate the learning of mathematical objects, reducing the factors that are causing anxiety in students. The technology used within an instructional design can enable students to focus on understanding concepts and solving problems rather than arithmetic operations. In the same way, the technology applied in the exams can support with the visualization and the simulation of situations.

The study of anxiety leads to a better understanding of the phenomenon and of the variable which are at play, presenting the possibility of carrying out actions aimed at decreasing anxiety. Strategies and actions for confronting the problem should be developed by trained personnel in order to provide the appropriate tools for students as well as teachers.

At the university level, there are various subjects which include mathematics such as calculus, linear algebra, differential equations, statistics and financial mathematics, among others. These subjects require specific studies in order to determine the factors which cause anxiety for students.

Future lines of study

It would be worth extending this study as a next step to explaining the phenomenon of anxiety towards mathematics and attitude towards the process of teaching mathematics using technology. To this end, we suggest using new variables based on the relationship between both constructs, which could provide new empirical evidence to this discipline. This proposal could prove valid since the construct of anxiety has strong cognitive and affective loads which fit into the affective part of confidence and commitment towards the process of teaching mathematics through technology.

REFERENCES

- Alexander, L., & Cobb, R. (1984). *Identification of the dimensions and predictions of mathematics anxiety among college students*. Paper presented at the meeting of the Mid-South Educational Research Association, New Orleans, LA.
- Alexander, L., & Martray, C. (1989). The Development of an Abbreviated Version of the Mathematics Anxiety Rating Scale. *Measurement and Evaluation in Counseling and Development*, 22(3), 143-150.
- Baloglu, M., & Zelhart, P. F. (2007). Psychometric properties of the revised mathematics anxiety rating scale. *The Psychological Record*, 57(4), 593.
- Barkatsas, A. T., Kasimatis, K., & Gialamas, V. (2009). Learning secondary mathematics with technology: Exploring the complex interrelationship between students' attitudes, engagement, gender and achievement. *Computers & Education*, 52(3), 562-570.
- Bowd, A. D., & Brady, P. H. (2002). Factorial structure of the Revised Mathematics Anxiety Rating Scale for undergraduate education majors. *Psychological reports*, 91(1), 199-200.
- Cabrol, M. & Székely, M. (Eds.). (2012). *Educación para la transformación*. Washington, D.C.: Banco Interamericano de Desarrollo. Retrieved from: <http://www10.iadb.org/intal/intalcdi/PE/2013/11771.pdf>
- Chiu, L. H., & Henry, L. L. (1990). Development and validation of the Mathematics Anxiety Scale for Children. *Measurement and Evaluation in Counseling and Development*, 23(3), 121-127.
- Coll, C. (2009). Aprender y enseñar con las TIC: expectativas, realidad y potencialidades. In R. Carneiro, J. C. Toscano & T. Díaz (Eds.), *Los desafíos de las TIC para el cambio educativo* (pp. 113-126), Madrid: OEI-Fundación Santillana.
- Eurydice. (2011). *La enseñanza de las matemáticas en Europa: Retos comunes y políticas nacionales*. Bruselas, Bélgica: Eurydice. Doi:10.2797/92132
- Fennema, E. & Sherman, J. (1976). Fennema-Sherman Mathematics Attitudes Scales: Instruments Designed to Measure Attitudes Toward the Learning of Mathematics by Males and Females. JSAS Catalog of Selected Documents in Psychology, 6, 31. (Ms. No. 1225). *Journal for Research in Mathematics Education*, 7, 324-326.
- Galbraith, P. & Haines, C. (1998). Disentangling the nexus: Attitudes to mathematics and technology in a computer learning environment. *Educational Studies in Mathematics*, 36, 275-290.
- García-Santillán, A. (2017) Measuring set latent variables through exploratory factor analysis with principal components extraction and confirmatory analysis. *European Journal of Pure and Applied Mathematics*, 10(2), 167-198.
- García-Santillán, A., Escalera-Chávez, M., Camarena-Gallardo, P. & García-Díaz Mirón, A. (2012). Structural Equations Modeling to Measure Variables Involved in the Interaction between Mathematics and Computer. *International Journal of Humanities and Social Science*, 2(24), 6-13.
- García-Santillán, A., Escalera-Chávez, M. E., & Córdova-Rangel, A. (2012). Variables to measure interaction among mathematics and computer through structural equation modeling. *Journal of Applied Mathematics & Bioinformatics*, 2(3), 51-67.

- García-Santillán, A., Venegas-Martínez, F., Escalera-Chávez, M. & Córdova-Rangel, A. (2013). Attitude towards statistics in engineering college: An empirical study in public university (UPA). *Journal of Statistical and Econometric Methods*, 2(1), 43-60.
- García-Santillán, A., Flores-Serrano, M., López-Morales, J. & Ríos-Álvarez, L. (2014). Factors Associated that Explain Anxiety toward Mathematics on Undergraduate Students. (An Empirical Study in Tierra Blanca Veracruz-México). *Mediterranean Journal of Social Sciences*, 5(15), 483-493.
- García-Santillán, A., Escalera-Chávez, M. E., Moreno-García, E. & Santana-Villegas, J. C. (2015). Factors that Explains Student Anxiety toward Mathematics. *Eurasia Journal of Mathematics, Science & Technology Education*, 12(2), 361-372.
- García-Santillán, A., Ortega-Ridaura, I., & Moreno-García, E. (2016). Actitud hacia la matemática y el rol de las tic en los procesos de enseñanza aprendizaje. Una aproximación para la definición de un modelo teórico [Attitude toward Mathematics and the role of ICT in teaching learning process. An approach to the definition of a theoretical mode]. *European Journal of Education Studies*, 1(2), 102-118.
- Gómez-Chacón, I. M. (2010). Actitudes de los estudiantes en el aprendizaje de las matemática con tecnología [Students' attitudes to learning mathematics with Technology]. *Enseñanza de las ciencias*, 28(2), 227-244.
- Hair, J. F., Anderson, R. E., Tatham, R. L. & Black, W. C. (1999). *Multivariate data analysis (Fifth edition)*. España: Prentice Hall.
- Ministry of Public Education. (2014). *Evaluación Nacional del Logro Académico en Centros Escolares. Educación media superior*. Retrieved from: <http://www.enlace.sep.gob.mx/ms/>
- Muñoz-Cantero, J.M. & Mato, M. D. (2007). Elaboración y estructura factorial de un cuestionario para medir la "ansiedad hacia las matemáticas" en alumnos de educación secundaria obligatoria [Elaboration and factorial structure of an questionnaire to measure math anxiety in students of compulsory secondary education]. *Revista Galego-Portuguesa de psicología e educación*, 14(1), 221-231.
- Muñoz-Cantero, J. M., & Mato, M. D. (2008). Análisis de las actitudes respecto a las matemáticas en alumnos de ESO [Analysis of attitudes about Mathematics in ESO students]. *Revista de Investigación Educativa*, 26(1), 209-226.
- Organisation for Economic Co-operation and Development. (2016). *Resultados de PISA 2015. Nota país. México*. Retrieved from: <https://www.oecd.org/pisa/PISA-2015-Mexico-ESP.pdf>
- Organización para la Cooperación y el Desarrollo Económicos. (2009). *Habilidades y competencias del siglo XXI para los aprendices del milenio en los países de la OCDE*. Retrieved from: http://recursostic.educacion.es/blogs/europa/media/blogs/europa/informes/Habilidades_y_competencias_siglo21_OCDE.pdf
- Pierce, R., Stacey, K., & Barkatsas, A. (2007). A scale for monitoring students' attitudes to learning Mathematics with Technology. *Computers & Education*, 48, 285-300.
- Plake, B. S., & Parker, C. S. (1982). The development and validation of a revised version of the Mathematics Anxiety Rating Scale. *Educational and Psychological Measurement*, 42, 551-557.
- Resnick, J. H., Viehe, J., & Segal, S. (1982). Is math anxiety a local phenomenon? A study of prevalence and dimensionality. *Journal of Counseling Psychology*, 29, 39-47.
- Richardson, F. & Suinn, R. (1972). The Mathematics Anxiety Rating Scale: Psychometric data. *Journal of Counseling Psychology*, 19(6), 551-554. doi:10.1037/h0033456
- Rounds, J. B., & Hendel, D. D. (1980). Measurement and dimensionality of mathematics anxiety. *Journal of Counseling Psychology*, 27, 138-149.
- Rouquette, J. & Suárez, A. (2013). Un nuevo escenario para la pertinencia del conocimiento matemático. *Reencuentro*, 1(68), 26-33. Retrieved from: <http://www.redalyc.org/articulo.oa?id=34030524004>
- Santiago, P., McGregor, I., Nusche, D., Ravela, P. & Toledo, D. (2012). *OECD Reviews of Evaluation and Assessment in Education: Mexico 2012*. Paris: OECD Publishing. doi:10.1787/9789264172647
- Suinn, R. & Winston, E. (2003). The Mathematics Anxiety Rating Scale, a brief version: psychometric data. *Psychological Reports*, 92(1), 167-173. doi:10.2466/pro.2003.92.1.167

Valverde, G. & Näslund-Hadley, E. (2010). *La condición de la educación en matemáticas y ciencias naturales en América Latina y el Caribe. Notas técnicas #IDB-TN-211 Banco Interamericano de Desarrollo*. Retrieved from: <http://www.oei.es/salactsi/bidciencias.pdf>

<http://www.ejmste.com>



<http://www.ejmste.com>



<https://twitter.com/ejmste>



<https://www.facebook.com/ejmste>



<http://modestum.co.uk/>



publications@modestum.co.uk



OPEN ACCESS

EURASIA Journal of Mathematics Science and Technology Education
ISSN: 1305-8223 (online) 1305-8215 (print)
2017 13(9):6231-6248
DOI: 10.12973/eurasia.2017.01061a



A Preliminary Study on the Learning Satisfaction and Effectiveness of VR Weight Training Assisting Learning System for Beginners

Peng-Wei Xiao

Graduate School Design Doctoral Program, National Yunlin University, Yunlin County, TAIWAN, ROC

Kuo-Kuang Fan

Graduate School Design Doctoral Program, National Yunlin University, Yunlin County, TAIWAN, ROC

Song Xu

Graduate School Design Doctoral Program, National Yunlin University, Yunlin County, TAIWAN, ROC

Chung-Ho Su

Department of Animation and Game Design, SHU-TE University, Kaohsiung City, TAIWAN, ROC

Received 10 April 2017 • Revised 21 July 2017 • Accepted 2 August 2017

ABSTRACT

In 2016, with the widespread use of the somatosensory technology, the improvement of virtual reality and the head-mounted monitors, a lot of research and innovation emerged. The VR head-mounted monitors aren't used at fixed places. Learning by using the First Person perspective to execute the games, learners can escape the limit of monitors. Beginners will reduce the willingness to learn due to incorrect movements, operating the devices without coaches, and unable to observe oneself simultaneously. This study is based on experiential VR device, using Virtual coach and expanding mirror for auxiliary teaching and observing self-training process. Experimental observation method and questionnaire survey are applied to test. The test subjects are 53 boys and girls aged 18 to 25 years old who haven't had contact with gym equipment. The study shows that 70 percent of the subjects hold a positive recognition towards the system operation and they can force on the correct position. The satisfaction is affected due to not being familiar with the way the game is operated for some learners. In the open questionnaire, learners mention that weight training materials provide them with the opportunity to view and correct their body movements and also raise learner's fitness will.

Keywords: weight training, virtual reality, experiential learning, somatosensory technology

INTRODUCTION

Due to the rise of computer animation and virtual reality, 3D movies and somatosensory games are gradually becoming universal. The intelligence of home technology became popular and virtual reality headset device allowed people to interact in 360 virtual spaces. Many companies have E-learning for related skills and training models that have also been launched.

© **Authors.** Terms and conditions of Creative Commons Attribution 4.0 International (CC BY 4.0) apply.

Correspondence: Chung-Ho Su, *Department of Animation and Game Design, SHU-TE University, No.59, Hengshan Rd., Yanchao Dist., 82445 Kaohsiung City, Taiwan.*

✉ mic6033@stu.edu.tw

State of the literature

- Beginners will reduce the willingness to learn due to incorrect movements operating the devices without coaches, and unable to observe oneself simultaneously.
- Virtual reality combined with the movement can show good results and response.
- Learners can learn the concepts and methods of fitness through learning procedures. Through The actual experience to observe and imitate the fitness action to achieve learning outcomes.

Contribution of this paper to the literature

- The most concrete result of this study is to construct VR weight training assistant teaching system.
- The researcher found from the satisfaction questionnaire and semi-structured interview that the most of the learners are well reflected in the system.
- Technology blend into life has become a trend. We can use this way to break the space and time constraints, also get exercise effects and reduce sports injuries.

Because the western trend of fitness as well as the raise of awareness about health, weight training becomes one of the hottest selections of sports in recent years. Most beginners are afraid to ask the coach or they read the equipment icon to operate by themselves the first time. And then they manipulate the sports equipment incorrectly and receive sports injury and reduce their training will. This is one of the motives of my research.

According to what mentioned above, gyms still use traditional equipment to do the training nowadays. They rarely combine the application of technology. Besides, there are plenty of pictures, articles and films online. Beginners face the variety of information and without the guidance of professional coach; they take the risks of experiencing actions and accuracy. The development of the somatosensory technology, relevant sport games and auxiliary teaching system finally emerged. Experiencing and learning through virtual equipment, beginners can reduce unnecessary sports injuries as well as raise the will to exercise. Most important of all, they can become skilled by practicing continuously (Yun-Her Hong, Wu-Zhou Chen & Hsiang-Wei Hung, 2015). Thus this research hopes to construct Digital Assisted Instruction System by using VR equipment. Beginners can use this system to practice their actions and to modify their actions as an auxiliary device. The system will be used as one of the auxiliary tools for fitness coach. The following are the purpose of this research:

1. Analyze the feasibility and acceptance of VR glasses combined with weight training in interactive operation learning.
2. Explore satisfaction & effectiveness of beginners in the “VR weight training Assisting Learning System.”
3. Provide beginners to correct the wrong posture and train the correct action, and explore the problems arising in the process.
4. Provide reference information for relating weight training and auxiliary teaching in the future

LITERATURE

Weight Training

Weight training is one of the physical training ways that can enhance muscle strength effectively. Muller and Hettinger, two German physiologists, conducted experiments about weight training principles in 1925, and they proved that the enhancement of muscle is proportional to the strength of stimulation, and it had nothing to do with the amount of exercise. According to Hettinger’s research in 1961, if the muscle training is done by the max stimulation, the muscle effect will last for one week, and then it will decline to the original state in two weeks (Hettinger R, 1961). Though the short-term training effect is good, the gained effect will vanish fast once you stop

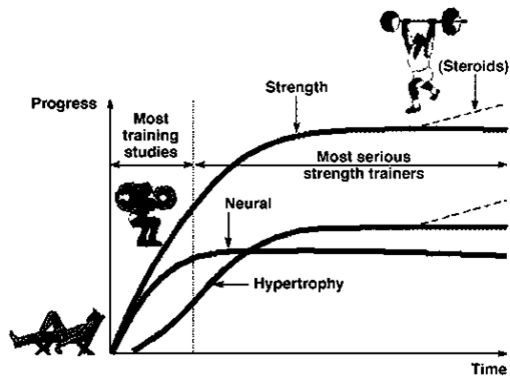

Figure 1. Weight training course frequency and length of time (From Weight training)

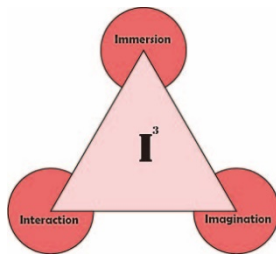

Figure 2. Three elements of virtual reality

training. So the regular habit of weight training can maintain a certain muscle mass and slow down the disappearance of muscle strength (Figure 1).

Virtual Reality and Related Research Applications

The application of Virtual Reality and relevant research Virtual Reality is also called VR. In 1935, Stanley G. Weinbaum, an American novelist, mentioned the glasses that can see the VR world in his novel. This is seen as the prototype of the VR development. The development of the relevant technology is also widely applied in academic research. In 1992, in the formal research papers "From Tool to amplify the mind" (Hamilton, J., Smith, E. T., McWilliams, G., Schwartz, E. I., & Carey, J., 1992), the initial research objective is set on medical engineering and educational engineering. In 1993, IEEE formally organized teams that research VR to seminar, extending VR technology to academic development. Thus, the connotation of VR includes three fields (Figure 2): Imagination Interaction and Immersion (Burdea G., 1993).

There are many examples applying VR technology to different fields domestic and abroad. In 2012, XBOX 360 released a video game-Nike+ Kinect Training, combining physical fitness and somatosensory. The game provides different training programs based on each player (Figure 3). In 2016, Yao-Hsien, Huang, an assistant professor at Department of Information Technology and Management in Shih Chien University, developed "VR Fitness Coach" that is based on somatosensory and immediate skeleton detection. It also combines ITRI's (Industrial Technology Research Institute) Foot Center of Gravity Pressure Sensor and develops the system. Players can experience the movements of squatting by VR equipment and modify the gestures as well as prevent sports injuries (Figure 4).

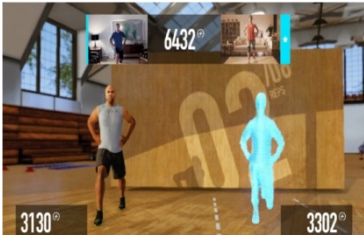

Figure 3. Nike+ Kinect Training (Retrieved from the X BOX360 sports game)



Figure 4. VR Virtual fitness coach (Retrieved from Apple Daily)

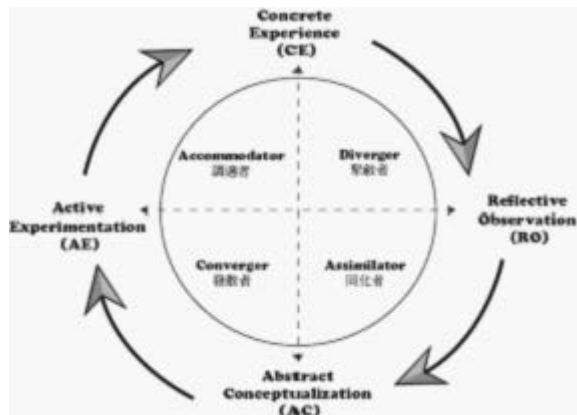

Figure 5. Kolb Experience Learning Cycle Diagram (Kolb, 1974)

Experiential Learning and Theory

Scholars from domestic and abroad mentioned the importance and continuity of the four stages of experiential learning cycle. The experience each stage will affect future experience activities. (Figure 5) Each stage is not a single cycle. It varies through the activities between people's interaction, including peers, learners themselves and instructors. Learners seek motivations from observation and imitation in the beginning. The clearer the goal is, the more the learning motivation can be enhanced. Hofer (2006) mentions that when the instructor provides an effective incentive strategy, positive learning affects learners' learning motivation. Learners will be more satisfied about course activity process, and thus learning outcomes will be improved.

In addition, experiential learning provides learners with related experiences. When entering the theme activity context, learning transfer is achieved by reflecting-what, generalizing and abstracting-so what. The goal is

achieved through the continuous learning cycle to develop. Experience transfer is the core of experiential learning. The goal can be achieved through learning procedures, learning roles, learning behavior and reflection feedback (Ving-Gi, He, 2001):

1. Learning procedures-- Understand the subject and purpose of the event. Through the activity process one can absorb knowledge theory, experience and practical implement of the technology.
2. Learning role-- Learning is achieved mainly by observation and imitation in the beginning, from which to find opportunities for participation and trigger learning motivation. After actually participating in the internship, one can design activities, and then go further for supervision and management and set the strategy to carry out activities.
3. Learning behavior-- By reading and doing field interviews, learning form class and discussion, engaging in the chosen work, and teaching others in cooperative learning.
4. Reflective feedback--Learners reflect on the way of the activity, groups and their own performance. The experience learned from the learning process, can be resolved with the rapid access to the situation for later similar related activities.

So this study uses this model and theory incorporated Into the VR fitness materials. Learners learn the concepts and methods of fitness through learning procedures. Through the actual experience learners observe and imitate fitness action, and then learn to operate the way to fitness simulation. And finally the action and reflection are tested through the break through experiencing the games. Experiences are accumulated to avoid sports injuries caused by operation of the actual equipment in the future. System teaching materials provide continuous training so learners can relearn until the action is correct.

METHODOLOGY

Once the concept of this study is formed and the topic is confirmed, relevant literature are collected for analysis. And then the structure is thus established. In addition, VR headset virtual reality fitness experience learning system content is built based on experiential learning theory. And then the questionnaires are written according to the purpose of this study and assumptions. Teddlie and Tashakkori (2009) think the mixed-methods research must have a complete process of problem formation, data collection, data analysis, and the interpretation of the results in the qualitative and quantitative orientation, and the results of the interpretation must link and discuss the relationship between qualitative and quantitative orientation. Sung, Chang, Lee & Yu (2008) mentions that both qualitative and quantitative approaches have their pros and cons. They can be adopted to make up for their shortcomings. The combination of the two can help to analyze and understand the overall situation. So, mixed-methods research was adopted in the embedded experimental design in this study, and then quasi-experimental design-based quantitative research with semi-structured interview was also adopted to understand the learning outcomes of beginners in the learning process.

This study focuses on modifying the action and learning of the college student beginners who use the VR headset device fitness experiential learning system. After the quasi-experimental study, the data collection and analysis are done based on users' system satisfaction questionnaire. The aim is to explore the VR headset fitness learning system combined with different experiential learning strategies and to know whether the beginners can correct the action and learn the correct concept of fitness effectively. And a qualitative interview with the users is conducted to understand the system more deeply for beginners learning the course of the impact (**Figure 6**).

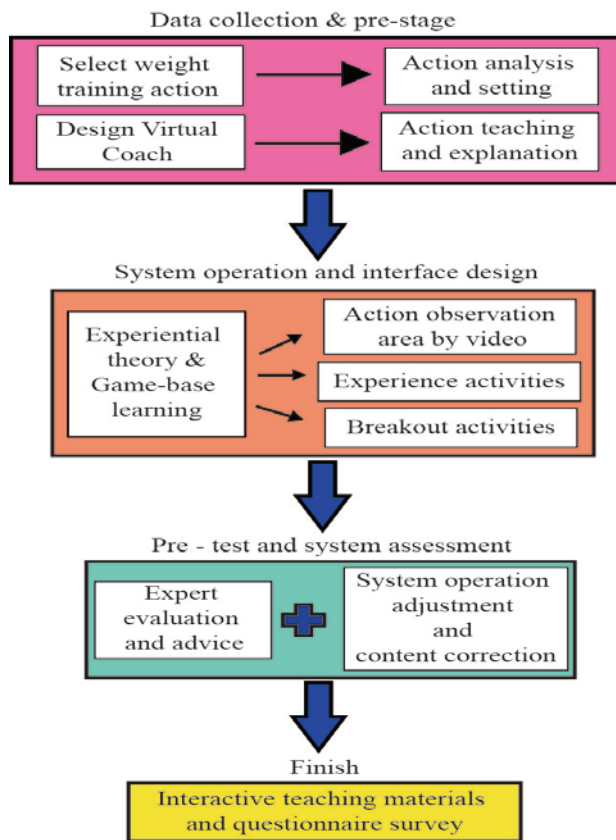

Figure 6. System content and evaluation flow chart (researcher design)

Research Objects

Alice Oglethorpe, the author of “Oprah.com”, mentioned that a normal person body’s muscle volume reduces year by year from the age of 30. When young people enter the adult stage, it is very helpful for the body aging to cultivate good and correct weight training habits and actions. (Alice Oglethorpe, 2016) So the subjects are 53 healthy college students (male 30, female 23) who are beginners on the weight training.

Experiment Process

To gain a better understanding of the practical operation and satisfaction and the effect after users experiencing “VR headset virtual reality fitness experiential learning system”, the experimental process is divided into three parts, “Experimental activity process”, “Scale assessment”, and “User interview history.” (Table 1) Most people are unfamiliar with VR headset, so the system operation instructions and practice will be provided before the experiment, so that users can be familiar with the overall operation of the system.

Table 1. Description of the experimental process

Experiment process	Time
A. Experimental activity process	
1) Description of experimental activities: Let the user understand the learning content, experimental goals and the overall activities.	5min
2) System operation and practice: Let the user understand the interface and the way and after the completion of the exercise.	15min
3) Formal experimental operation: The user conducts formal experience activities, and completes the learning content.	30min
B. Scale assessment	10min
The user performs a system satisfaction scale as a basis for further analysis.	
C. Individual interviews with users	10min
Through the one-on-one interview to understand the user's overall system of operation experience and learning experience to facilitate the relevant analysis.	

Study Tool

This study uses VR headset virtual reality learning system as an experimental tool for weight training, supplemented by expert interviews, beginner's personal information sheet, activity watch list, overall system assessment scale as a research help. They are described below.

1. Outline of the interview

A semi-structured questionnaire interview has been conducted to this study after the experiment. The following is the outline of the interview.

- a. When it comes to dumbbells, push-up rack and elastic rope, how do you benefit from VR headset fitness experiential learning system?
- b. Can you link the real equipment and get inspiration through the system learning?
- c. Other ideas and suggestions?

2. Activity observation record method

The experimental activity is conducted by direct observation method, supplemented by photography and video recording. The observer is assisting in completing the observation chart, recording the actual operation and helping users solve problems, and further analysis of its observations.

3. The scale of the system usage satisfaction

This study mainly uses the scale of the system usage satisfaction to evaluate overall content, feature design, interface and visual design. Likert-scale Five-point scale is adopted. Totally agree—5 points, agree—4 points, common—3 points, disagree—2 points, totally disagree—1 point. The points are given to facilitate subsequent quantitative analysis.

4. VR headset virtual reality fitness experiential learning system

This study uses the experiential learning theory and the digital learning system content design. And the head-mounted display is used as the study of hardware equipment. A virtual scene, objects and characters are constructed with 3D MAX and Unity 3D. The Interface design use Illustrator and Photoshop to match, and implemented in the VR headset device and Kinect Somatosensory sensor.

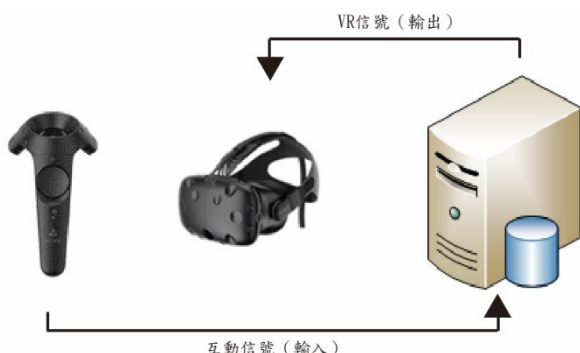

Figure 7. VR virtual reality weight training assistant teaching system data flow diagram

Data Processing

1. Statistical analysis of quantitative data

In this study, SPSS22.0 statistical software was used for data processing. The main data source is from VR system usage satisfaction scale. Descriptive statistics and analysis of quantitative research methods of correlation analysis are also adopted.

2. Analysis of qualitative data

User s' interview data are verbatim organized according to the outline of the semi-structured interview to ensure the correctness. The contents of the interview are sorted out and analyzed, and confirmed by interviewers as well. The code is compiled as S-1-1060315, S stands for student, No. 1 number, and the interview was conducted on March 15, 2017.

DESIGN THE SYSTEM FOR VR HEADSET VIRTUAL REALITY FITNESS OF EXPERIENCE LEARNING

This research is based on Microsoft Windows operating system and the Unity3D Game Engine is used as the main development platform while the HTC VIVE is used as the main interactive platform. This research system is User-oriented. The design of this system features in stability and structure. The purpose is to gain long term, Multi-frequency user Interactive detection. The system uses two signals' as the main I/O signal: VR signal and Interactive signal. The VR signal transmits to VR helmet through computing platform and then to the users' eyes. The interactive signal is the opposite. Users use interactive handle to trigger interactive switch (Entity/VR).The interactive handle transmit the switch signal to the computer center to perform operations and the result is feedback to VR helmet to present entity (Figure 7).

This teaching system is composed of three parts: computing center, VR platform and users. The VR platform includes VR Display module and somatosensory interaction module (Figure 8). The main purpose of computing center is for computing tasks and storing initial teaching environment. VR platform is the main interface for users' interaction. Users gain interactive information Display module presented in visual form through VR display module. Using somatosensory interaction module and VR space to interact, the teaching objectives are reached and this is the important part of this system. It provides instant interactive message. It is the main motivation for the system's alteration as well as one of the important variables of the VR weight training teaching system.

THE DESIGN AND DEVELOPMENT OF SYSTEM CONTENT

This research Interactive design the scenes and objects by 3D MAX and Unity 3D (Figure 9), while the operation interface, System style and the Related Stickers are adjusted by Illustrator and Photoshop. Program language control, VR glasses and controller are used to integrate VR Somatosensory Teaching system in the end.

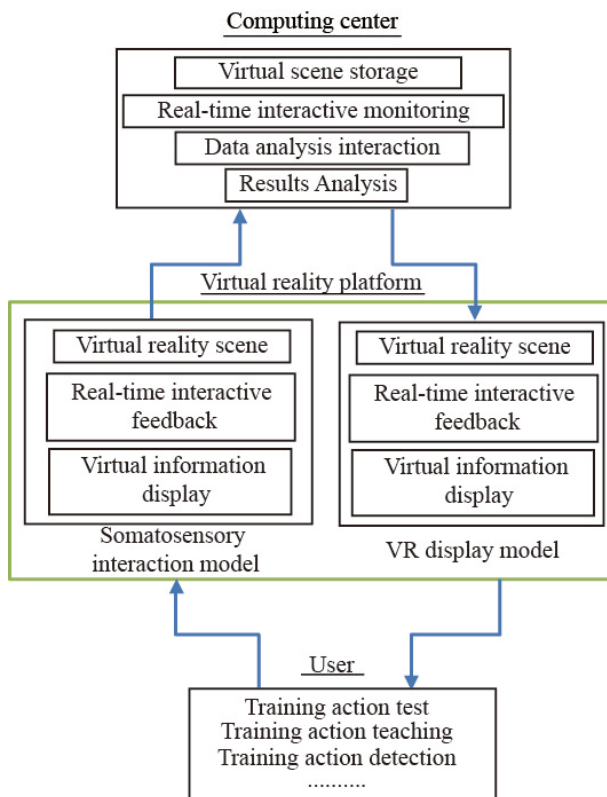

Figure 8. VR virtual reality weight training assistant teaching system architecture diagram (Researcher design)

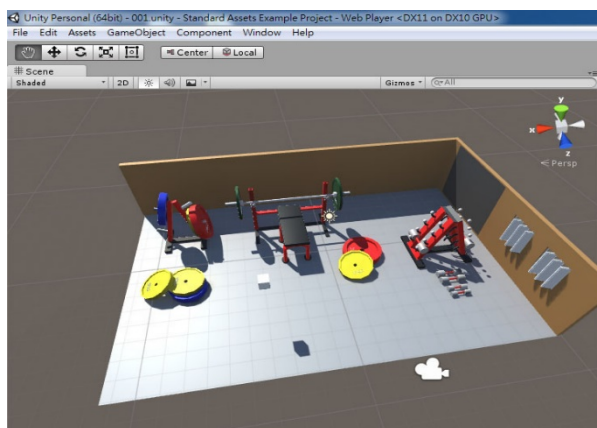

Figure 9. System scene design (researcher design)

System content and operation will be evaluated by three Digital media experts. Two professional fitness coaches will guide the system action. Questions and advice will be modified.

This Research teaching system is composed of four parts. 1. The description of the chest fitness concept. 2. Equipment instructions. (The explanation of the wrong actions) 3. Coach demonstration & practice. 4. Fitness game experience. Related content design is shown as [Table 2](#).

Table 2. System Unit Description

Item	Content description
Fitness Concept Description	The first part provides the basic fitness concept description for beginners.
Equipment Instructions (Explain the Wrong Action)	Some common and easy to get Fitness Equipments are chosen by the designer. The training parts and gestures are incorporated in teaching system. The common seen wrong actions and the instructions will be provided.
Coach Demonstration & Practice	The Virtual coach demonstrates Fitness training. Learners practice and learn through VR.
Fitness game experience	The system designs four kinds of fitness equipments. Learners can choose equipment and experience the game.

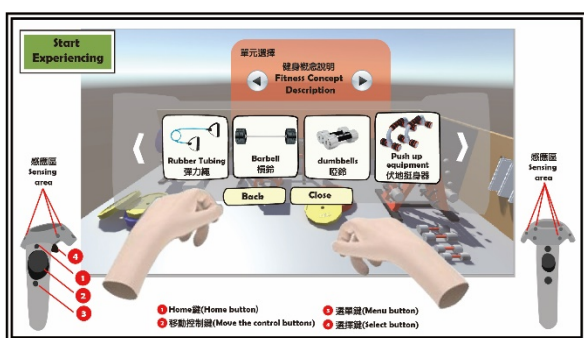

Figure 10. System operation interface (Researcher design)

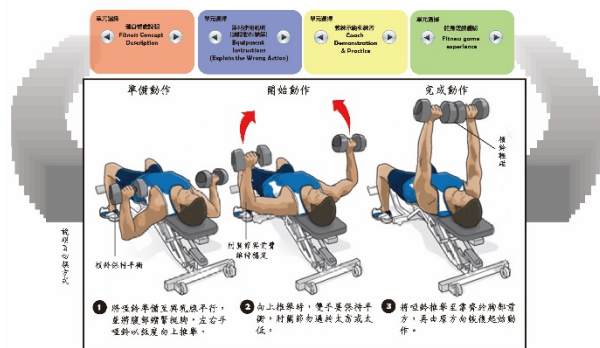

Figure 11. Fitness trainer demonstration (Researcher design)

The Design of the Operation Interface

Once you enter the system screen (Figure 10), prompt of the Virtual controller will show on the left and right sides. Four pieces of equipment are offered for learners to choose. After choosing the equipment, learners will choose the unit. The right and wrong actions will be explained as well as the demonstration and practice of the coach (Figure 11). Learners can go further to experience the games and upgrade the levels.

Tested by the Subject

Subject selected equipment and started the experience of practice. People Use Virtual Reality for do fitness. The action is divided into preparation action → start action → completed, the subjects can continue to repeat the operation (Figure 12, Figure 13, Figure 14, & Figure 15).

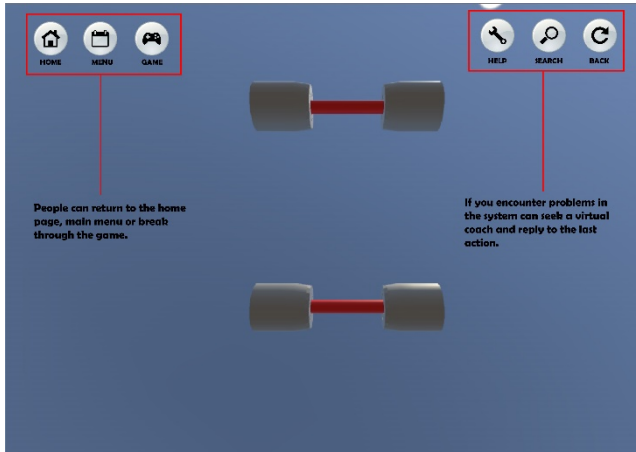

Figure 12. System operation screen (Researcher design)

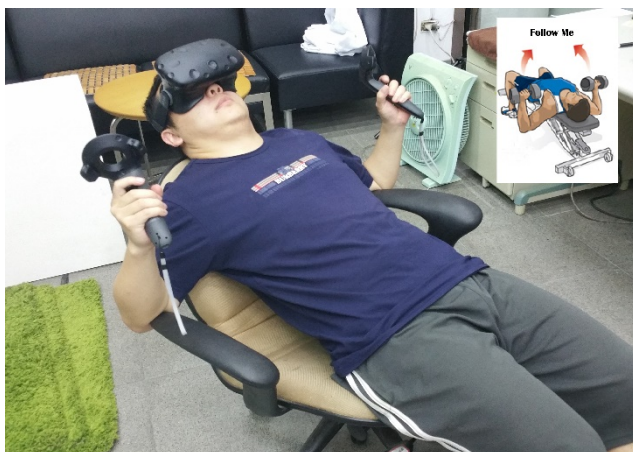

Figure 13. The subject starts the action (Researcher design)



Figure 14. The subject began to move (Researcher design)

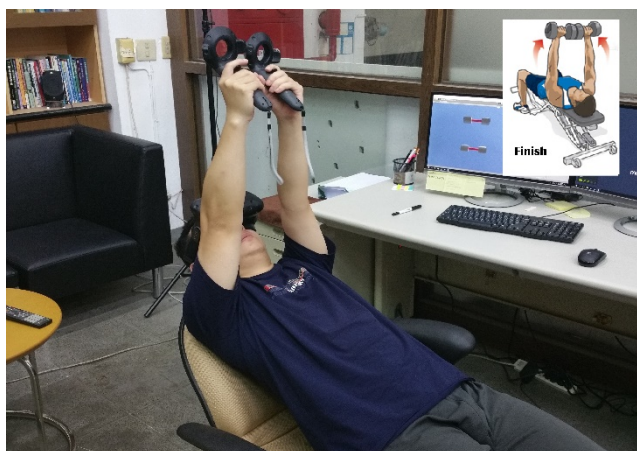

Figure 15. The subject completes the action (Researcher design)

Table 3. The credibility analysis of the scale of the system usage satisfaction

Evaluation content	Number of questions	Type	α value	Standardized item α value
The whole content design	11	Likert Five-Point Scale	0.886	0.904
feature design	6	Likert Five-Point Scale	0.898	0.901
Interface and visual design	11	Likert Five-Point Scale	0.793	0.812
The whole credibility			0.946	0.950

ANALYSIS OF RESULT

The major development of this research is the game system of VR Fitness experience learning. Operation interface, Operating fluency, and the rules are modified after pretesting the prototype and the evaluation of the experts. Likert-scale Five-point scale is adopted to the satisfaction scale of this system evaluation. Totally agree—5 points, agree—4 points, common—3 points, disagree—2 points, totally disagree—1 points. The result of the item is calculated based on the average and standard value.

As for the credibility of this research, the system is analyzed by SPSS 22.0. The Cronbach’s value of the detection of System learning Content evaluation and usability about overall content design, feature design, and Interface visual design are 0.886, 0.898, 0.793. The whole α value is 0.946. The values of the evaluation items are all greater than 0.7. The Scale is among high credibility. In other words, the scale has a certain degree of credibility. (Table 3) The formal tests on 53 college students (59.3% of the Valid samples have experienced VR Wearable device, 40.7% haven’t) to conduct the experiments. The following are the related experimental results and analysis.

Quantitative Data Collation Analysis

The overall content analysis of the user satisfaction scale

The average value of the overall content of VR Game system is 4.27, which shows that most of the subjects tend to agree with this system (Table 4). The recognition degree values of the game levels and VR coach experience learning are 4.55, 4.72, 3.38. Most subjects think VR coaches are helpful for the learners in the system. As for the rules to play the system, 70 percent of the subjects hold positive recognition about the system operation and they can all push on the correct position. The part about assisting learners in experiencing fitness movements, chest muscle groups are trained through prompt areas. As for assisting learners the status of fitness experiencing, chest

Table 4. The test results of the "Overall Content" of the VR fitness experience system

Questions	Evaluate score (percentage)					Average score	Standard deviation
	5	4	3	2	1		
Recognition degree about the game levels and virtual coach experience learning.							
1. Virtual coach teaching is very helpful to me.	74.5%	19.6%	5.9%	0%	0%	4.55	0.972
2. I can understand the equipment operating method by virtual coach's teaching and practice.	78.4%	17.6%	4%	0%	0%	4.72	0.841
3. I can challenge the suitable game level according to my skill level.	64.7%	25.5%	9.8%	0%	0%	3.38	0.686
Acceptance of the rules to play.							
4. I know how to push on the correct area of the equipment.	78.4%	13.7%	7.9%	0%	0%	4.66	0.706
5. I can handle the equipments provided by the system and experience the training parts.	76.5%	15.7%	5.9%	1.9%	0%	4.22	0.847
The status of assisting learners about experiencing fitness actions.							
6. I think it helps me realize related equipment training after experiencing VR fitness system.	78.4%	15.7%	5.9%	0%	0%	4.33	0.876
7. I will adjust to the standard action before starting training.	72.5%	19.6%	7.9%	0%	0%	4.49	0.869
Overall evaluation							
8. Through the VR fitness experience system I can clearly realize the fitness training actions.	78.4%	15.7%	2%	3.9%	0%	4.19	1.226
9 VR fitness game is helpful to me.	72.5%	17.6%	9.8%	0%	0%	4.49	0.869
10 I think I can operate real equipments after using VR fitness experience system.	66.7%	25.5%	3.9%	3.9%	0%	3.96	0.940
11 I can fully understand the concept conveyed in the VR fitness experience system.	68.6%	23.5%	5.9%	2%	0%	3.98	1.248
Average	73.6%	19.1%	6.3%	1%	0%	4.27	

muscle groups are trained through prompt areas. Learners have confidence before they face real equipments and are ready for training actions. As for the overall evaluation section, most people hold positive recognition about VR fitness game system for incorporating VR games in fitness system. The Standard deviation is less than 0.75 in questions 3 and 4.

Feature design analysis of user satisfaction scale

The test results in feature design, as **Table 5** shows, the body show blocks of prompt function and Game experiencing are 4.17 and 4.21. Most subjects agree that they can clearly understand the body training site while operating the system. The design of Restart and Life Value can make the subjects more concentrate on thinking about the correctness of the actions. Finally, in the whole question evaluation, more than 50 percent subjects totally agree that they can complete the game break through the target via designed system function. Up to 89.5% of the whole part of the questionnaire agrees the result presented in the feature design. (50.9% very much agree, 38.6% agree)

Table 5. The test results of the “Feature Design” of the VR fitness experience system

Questions	Evaluate score (percentage)					Average score	Standard deviation
	5	4	3	2	1		
System prompt function evaluation							
1. System prompt function evaluation	49.0%	37.3%	7.8%	3.9%	2.0%	4.17	1.076
2. The system’s show blocks clearly tells me which body part to train.	47.0%	39.2%	11.8%	0%	2.0%	4.21	1.008
The feature design of the systems’ Restart function and Game Life Value							
3. The Restart function lets me continue to practice, thus actions memory and correction are done.	51.0%	47.1	3.9%	2.0%	2.0%	4.32	0.911
4. The design of “Life Value” in the game lets me think more about the correctness of the actions while plying the game.	54.9%	39.2%	5.9%	0%	0%	4.41	0.933
Overall evaluation							
5. I can clearly understand the goal that I have to complete.	58.8%	27.5%	5.9%	3.9%	3.9%	3.91	0.925
6. The GOAL function lets me able to focus on the completion of fitness actions while playing the game.	51.0%	41.2%	3.9%	3.9%	0%	4.33	0.769
Average	50.9%	38.6%	6.5%	2.3%	1.7%	4.22	

Interface and visual design analysis of user satisfaction scale

The test results of the interface and visual design, shown as **Table 6**, the interface text arrangement design (4.13, 4.34, 4.53), the friendly design of interface (4.34, 4.58, 4.55), the visual design of the system and characters (4.40, 3.89), and the overall evaluation (4.26, 3.60, 3.91), the total average of the overall standard deviation is 4.23, which shows that most subjects tend to agree with this system’s presented effect of Interface and Visual design. More than 70 percent of the subjects agree with the menu interface and the friendly of operation. Yet there is still room for improvements in edition of the text, equipment menu, and overall game interface.

Analysis of Qualitative Data

The interview data were summarized in this study, and how beginners can benefit from VR headset fitness experiential learning system when using dumbbells, push-up rack and elastic rope were sorted out. The following is an analysis of the interview data.

How do you benefit from VR headset fitness experiential learning system when using dumbbells, push-up rack and elastic rope?

1. The VR system allows beginners to have interest in fitness, understand and adjust training action.
 - a. I have not been in contact with fitness before.

Most relevant fitness information is collected on the Internet. I’m not sure whether my actions are correct. Sometimes I feel sore after the training. But through this experiential learning system, I can follow the virtual coach to do actions and adjust my training posture. When I go back I want to try again (S-24-1060318).

- b. I have played some VR games before. This time it’s a new experience. I understand the dumbbells, push-up rack and elastic rope training methods through the experiential fitness learning system. It’s very exciting and interesting (S-20-1060318).

Table 6. The test results of "Interface and Visual Design" of the VR fitness experience system

Questions	Evaluate score (percentage)					Average score	Standard deviation
	5	4	3	2	1		
The system and the Game interface text, icon, and the edition of button menu							
1. The text in the system and games is clear and appropriate.	47.1%	33.3%	15.7%	3.9%	0%	4.13	1.040
2. The edition of the icon in the system and games is clear.	53%	41.1%	0%	3.9%	2.0%	4.34	0.921
3. The buttons and menu in the system and games let me easy to choose.	74.5%	17.6%	3.9%	2.0%	2.0%	4.53	0.908
The friendly design of the interface operation							
4. The Interactive screen in the system and games let me easy to focus on.	56.8%	27.5%	15.7%	0%	0%	4.34	0.830
5. It's easy to operate the system and games, I can still remember how to operate it next time.	76.5%	19.6%	3.9%	0%	0%	4.58	0.824
6. The interface design in the system and games let me easy to operate it.	78.4%	15.7%	3.9%	2%	0%	4.55	1.022
The visual design of the system environment and virtual characters							
7. The design style of the game, System scene, and virtual coach attract my attention.	60.8%	33.3%	3.9%	2%	0%	4.40	0.975
8. The color of the game is in harmony with that in the system, which is easy to read and operate.	54.9%	29.4%	13.7%	2%	0%	3.89	1.064
Overall evaluation							
9. I can understand and correctly select the icon of Elastic rope, dumbbell, push-up rack and barbell.	47.1%	35.3%	17.6%	0%	0%	4.26	0.763
10. Overall, I think the game interface is well designed.	43.1%	39.2%	15.7%	2%	0%	3.60	0.776
11. The overall color of the system doesn't make my eyes uncomfortable.	56.8%	31.4%	11.8%	0%	0%	3.91	1.213
Average	59.0%	29.4%	9.6%	1.6%	0.4%	4.23	

- c. I can know exactly which part of the body I'm training through the explanation, system diagram introduction, and the virtual coach assistance. And I can operate with the correct posture (S-8-1060315).
2. VR system can enhance learning interest, but it will cause trouble for those who have not operated VR before.
 - a. The use of VR headset fitness experiential learning system can enhance learning interest. I used to go to the physical gym or spend money to ask the coach to get professional knowledge and posture. Through the game and VR experience I can adjust unfamiliar action and posture. It's very interesting(S-30-1060318).
 - b. I have not played VR before. I don't get hang of operating the system and games. The technology is developing rapidly, and the operation mode is getting more diversified. Besides, many devices are a little expensive, I'm not used to such a mode of operation (S-47-1060320).

Can you link the real equipment and get inspiration through the system?

Professional fitness instructors mention that most of the training starts mechanically since the action is more consistent and fixed. But mechanical training must go to the physical gym to carry out. Many people are also curious about how to use the mechanical equipment of the gym. The equipment provided in this research system is commercially available. They are smaller and cheaper compared with mechanical equipment. From the questionnaire, we can understand that the subjects have a high degree of acceptance towards the easily accessed equipment. And the concept and action of fitness can be learned through the system and games. It's described below:

- a. Although the operation of dumbbells, elastic rope and push-up rack in the system is very interesting, I also have elastic rope and push-up rack at home which can help me to learn the relevant fitness posture. But I have been to the school gym and there is quite a lot of mechanical equipments there. How do I train myself when facing mechanical equipment (S-51-1060320)?
- b. I am petite. I wonder if the operation of physical dumbbell is the same as the system. When I go back I would like to give it a try(S-35-1060319).

Other ideas and suggestions

In the system, interface menu and resources are very rich. I hope that related topics of operation for different parts of the body can be designed in the future. But the text is a bit small in some places such as the part of the action diagram(S-1-1060315). The design of system icons is great. To me, it will be very boring if it only focuses on training. The system uses games and multimedia to increase learning content and fun. In addition to a wealth of illustrations, learning becomes a very interesting thing. It is so called learning by doing(S-40-1060319).

CONCLUSION AND SUGGESTIONS

The most concrete result of this study is to construct VR weight training assistant teaching system. In addition to the headset display device combined with somatosensory, the teaching models of experiential learning theory are also incorporated into the system content. In addition to the basic teaching and experience, activities are carried out in a game way. The evaluation and amendment of the system are done before and after the tests. Questionnaire and interviews are done after beginners use the system. Analysis of its relevance, satisfaction and effectiveness are made to provide future reference for new media technology integration research. The following will explain the features of the VR wear device in the fitness experience learning system:

Auxiliary Beginners Have a Sense of Immersion

From the interview and observation on the spot, researchers realize that most of the subjects are absorbed in the operating system. Operating the system is very similar to practical experience. They think they were really exercising in the actual gym. The study shows that the system through the VR technology can be effective for beginners to produce a sense of immersion, from which users can achieve the effect and fun.

VR Learning Process and Game Interaction

Fitness exercise emphasizes the actual feelings, so the actual learning experience is very important. The actual virtual space is simulated by the VR headset, which lets the subject (beginner) know the fitness actions and concepts in advance before they go to the gym. They can experience the relevant training methods, increase the willingness to go to the gym and to reduce the chance of injury.

FUTURE SYSTEM CONSTRUCTION AND RESEARCH PROPOSAL

Increased Selectivity of Equipment Operation

This study uses elastic rope, simple barbell, dumbbell and push-up rack, commonly seen on the market, as system fitness aids. The mechanical equipment in the gym is not designed in the system. More equipment can be designed in the system in the future. Not only for beginners, but the general public or the elderly can also carry out equipment experience and teaching.

Combined with Pressure Sensor for Measurement

The current game is built for the initial operation mode, so the system game operation is a little simple. Advanced training actions and the difficulty of breaking through will be added in the future to increase the richness of the system. In addition, the gym has a real bar or dumbbell weight. Related technology system of pressure sensor from Shih Chien University can be modeled to increase the effect of VR experience. More realistic simulation of the actual fitness of the telepresence can be made.

Increase the Network Platform Connection or Immediate Teaching

The current system only provides software on PC. Sports training with peer encouragement and help can improve the sporting effect. Training against each other, immediate professional coaching teaching, and online discussion for teaching and learning all can be done online in the future. So the fitness problems beginners encounter can be solved on the spot.

Add Sports Record

This study focuses on the VR fitness experience system on learning satisfaction and achievement, sports record function can be added in the future so that beginners can record their own state of motion at any time. (Such as: heartbeat, respiratory rate, training index and weight.) The coaches or trainers can understand their own situation to adjust and amend the next time they use the system. With professional records and learning, the sports effect can be enhanced and the sports injuries can be reduced.

REFERENCES

- Alice, O. (2016). The Best Exercise for Your Age. *The Huffington Post*.
- Biocca, F., Kim, J., & Choi, Y. (2007). Visual touch in virtual environments: An exploratory study of presence, multimodal interfaces, and cross-modal sensory illusions. *Teleoperators and Virtual Environments*, 10(3), 247-265.
- Burdea, G. C. (1993). Virtual Reality System and Application. *Eletro'93, International Conference*. NJ: Short Course.
- Burdea, G. C., & Coiffet, P. (2003). *Virtual reality technology*. Hoboken, NJ: John Wiley & Sons.
- Coyne, C. (2008). Video Games in the Clinic PTS Report Early Results. *PT Magazine*, 16(5), 22-28.
- Deutsch, J. E., Borbely, M., Filler, J., Huhn, K., & Guarrera-Bowlby, P. (2008). Use of a low-cost, commercially available gaming console (Wii) for rehabilitation of an adolescent with cerebral palsy. *Physical Therapy*, 88, 1196-1207.
- Gruneau, R. (1999). *Class, Sports and Social Development*. United States: Human Kinetics.
- Hamilton, J., Smith, E. T., McWilliams, G., Schwartz, E. I., & Carey, J. (1992). Virtual Reality: How a computer-generated world could change the real world. *Business Week*, 3286, 97-105.
- Hettinger, R. (1961). *Physoreniology of Strength*. Springfield: Charles C. Thomas.
- Hofer, B. K. (2006). Motivation in the college classroom. In W. J. McKeachie, & M. Svinicki (Eds.), *McKeachie's teaching tips: Strategies, research, and theory for college and university teachers (12th ed.)*, 140-150. Boston: Houghton Mifflin.

- Mellecker, R. R., & McManus, A. M. (2008). Energy Expenditure and Cardiovascular Responses to Seated and Active Gaming in Children. *Arch Pediatr Adolesc Med*, 162(9), 886-891.
- Sternberg, R. J. (1985). *Teaching critical thinking, part 2: possible*.
- Sung, Y. T., Chang, K. E., Lee, Y. H., & Yu, W. C. (2008). Effects of a mobile electronic guidebook on visitors' attention and visiting behaviors. *Educational Technology and Society*, 11(2), 67-80.
- Teddlie, C., & Tashakkori, A. (2009). *Foundations of mixed methods research*. Los Angeles, CA: Sage.
- Ving-Gi, He, (2001). Learning difficulties in the diagnosis and remediation teaching. *Study counseling*, 223-274, Taipei: Psychology Press.
- Yun-Her, H., Wu-Zhou, C., & Hsiang-Wei, H. (2015). *The Study of Social Network Assisted Teaching on Tai Chi Chuan*, 112, 51-67.

<http://www.ejmste.com>



OPEN ACCESS

EURASIA Journal of Mathematics Science and Technology Education
ISSN: 1305-8223 (online) 1305-8215 (print)
2017 13(9):6249-6283
DOI: 10.12973/eurasia.2017.01062a



Curriculum Development for Enhancing the Imagination in the Technology Commercialization Process

Chi-Yo Huang

National Taiwan Normal University, TAIWAN

Yu-Sheng Kao

The University of Tokyo, JAPAN

Hsueh-Hsin Lu

National Taiwan Normal University, TAIWAN

Ming-Jenn Wu

National Taiwan Normal University, TAIWAN

Received 30 September 2016 • Revised 1 November 2016 • Accepted 3 November 2016

ABSTRACT

The imagination capability in technology commercialization is the key success factor for innovation. However, higher education in general and engineering-related curricula in particular, has offered limited courses incorporating imagination. A complete and well-verified curriculum that will enhance the imagination capability in technology commercialization is critical and imperative to resolve the problem. Thus, this research summarizes possible course modules and the criteria for evaluating and selecting the core modules based upon a literature review. Final criteria were defined by using the modified Delphi method. The influence relationships of each criterion on the others were derived by the Decision-Making Trial and Evaluation Laboratory (DEMATEL). Subsequently, the derivation of critical criteria, a weight was defined for each criterion by using the DEMATEL-based Network Process (DNP). Finally, the correlations between the criteria and the course modules were derived by using the Grey Relational Analysis (GRA). Based on the analytic results, QFD, TRIZ, and SCAMPER courses were recognized by the experts as important for enhancing engineering students' imagination capabilities.

Keywords: technology commercialization, imagination, creativity, multiple criteria decision making, curriculum development

INTRODUCTION

Einstein had ever stated, "Imagination is more important than knowledge. Knowledge is limited, whereas imagination embraces the entire world, stimulating progress, giving birth to evolution." Imagination is an agency-focused "possibility thinking" (Craft, Chappell, & Twining, 2008) that is peculiarly suited to be the vehicle of active creativity (Gaut, 2003). Morosini (2010) suggested that imagination could be regarded as the conduit through which the unconscious self would find its way out in the form of creative mental imagery that could drive deliberate actions. Creativity has not only long been considered an important source of innovation and competitive strength for organizations (Udwadia, 1990), but also it has a strong relation with invention and innovation. Without creativity in design, there would be no potential for innovation, with which creative ideas are actually implemented

© **Authors.** Terms and conditions of Creative Commons Attribution 4.0 International (CC BY 4.0) apply.

Correspondence: Ming-Jenn Wu, *Department of Industrial Education, National Taiwan Normal University, Taiwan.*

✉ t07010@ntnu.edu.tw

State of the literature

- The activity of technology commercialization being related to idea generation, technology development, new product revisions, manufacturing, etc., is seen as an innovation process by innovation capability and creative imagination in product innovation management and product planning (Calantone, Di Benedetto, & Rubera, 2012).
- Chu and Quek (2013) argued that the imagination can be shaped through experiences, and thereby contributes to creative activities; if such creative activities are perceived as new, the products of imagination become creative.
- The key criteria for measuring the imagination capability can be classified as three types: initiating, conceiving, and transforming (Lin, Hsu, & Liang, 2014).

Contribution of this paper to the literature

- The evaluations of imagination enhancement strategies as well as course modules for enhancing imagination in the technology commercialization process are provided in this research.
- This research defines an analytic framework for exploring the influence relationship between evaluation criteria for the course modules for enhancing imagination in the technology commercialization process, deriving the associate weights versus the criteria, and defining appropriate imagination enhancement course modules.
- The analytic framework and research results can serve as a basis for curriculum design for enhancing engineering imagination. The curriculum being developed can be applied to enhance engineering students' imagination capabilities in technology commercialization.

(T. M. Amabile, 1997; Mumford & Gustafson, 1988) and transformed into commercial value (Howard, Culley, & Dekoninck, 2008; Thompson & Lordan, 1999). Because the imagination, creativity and innovation capabilities are essential for successful commercialization of new products or services, a lack of imagination is viewed as problematic in a rapidly changing technology-oriented world, where generating new ideas is essential to survival (Klukken, Parsons, & Columbus, 1997). The more quickly things change, the more imagination one needs to keep up.

Human beings are born with imagination, the major driver for the progress of humankind. Imagination is the source of creativity. Sufficient creativity is the source of innovation. Continuous innovation can propel the long-term development of the national economy. Civilization cannot establish technology and culture without innovation. Innovation depends upon invention. Inventions should be managed and commercialized before contributing towards the growth and profitability of an organization. Thus, innovation includes all technology commercialization activities related to idea generation, technology development, new product or product revisions, manufacturing, etc. Technology commercialization is also called product planning, product innovation management or new products management (Calantone, Di Benedetto, & Rubera, 2012). In many industries, technology commercialization is the most important driving force to compete successfully in modern society.

Most of the companies in industry earned more than one-third of their sales and profit in the past years from the development of new products (Barczak, Griffin, & Kahn, 2009). Owing to globalization, technology commercialization is becoming increasingly important to sustain competitiveness in modern industry. Hence, developing new technology and commercialization of novel technology is profitable for businesses. Investment in process innovation can reduce production costs. An advance in information technology also plays a significant role in accelerating the commercialization of technology. These technologies help companies develop and produce more diversity in products to cater to the needs of minorities and be close to the customer base, thereby achieving differentiation from competitors.

Imagination can be taught (Liu & Noppe-Brandon, 2009). It is widely believed that a child's imagination ought to be stimulated and developed in education (Doiron & Egan, 1993). Yet few teachers understand what imagination is or how it lends itself to practical methods and techniques that can be used easily

in classroom instruction (Doiron & Egan, 1993). Industrial leaders have long expressed a mounting concern about the impact of traditional engineering education on the creative potential of future engineers (i.e., lacking design capability or creativity, as well as an appreciation for considering alternatives) (Ogot & Okudan, 2006). Therefore, the stimulation and development of engineering students' imagination capabilities can further enhance the creativity and thus the innovation capabilities of the students. Higher education plays an important role in providing people with skills for innovation, but a number of important questions remain as to what kind of higher education teaching would be conducive to strengthen the skills (Hoidn & Kärkkäinen, 2014) and the imagination as well as the creativity capabilities for innovation. In the past several years, universities in the leading economies have responded to these challenges by adding more design content and introducing more open-ended design problems into their engineering curricula (Ogot & Okudan, 2006). Yet the need persists to increase the creative potential of graduates (McGraw, 2004).

Apparently, the technology commercialization imagination capability is the key success factor for innovation. However, the availability of such a curriculum being available in universities in general, and in engineering, design, management of engineering or technology management related curricula in particular, is still insufficient to fulfill education and industry needs, even in the United States and other developed or developing economies. To resolve the problem and enhance the technology commercialization planning imagination capability, constructing a complete and well-verified technology commercialization curriculum is critical and urgent. Thus, this research summarized possible course modules that could stimulate or enhance engineering students' imagination capability.

The possible course modules include TRIZ, SCAMPER, Quality Function Deployment (QFD), scenario analysis, brainstorming, etc.; the course modules were further derived by using the brainstorming method. Possible decision factors for selecting the course modules were proposed as evaluation criteria based on literature review results and then confirmed by using the modified Delphi method with opinions collected from engineering education experts. Then, using the Decision-Making Trial and Evaluation Laboratory (DEMATEL), the influence relations of one criterion on others were derived. Following the derivation of critical factors, a weight for each criterion was defined using the DEMATEL based Analytic Network Process (DNP). Finally, the relationship between the criteria for evaluating the technology commercialization imagination capability and the imagination course modules was derived, using the Grey Relational Analysis (GRA) by introducing the weights corresponding to each criterion. The most important imagination course modules were selected as the content of the curricula to stimulate and enhance engineering imagination capabilities for technology commercialization.

The definition of the curricula for stimulating and enhancing engineering students' imagination was based on opinions provided by eleven experts in the related fields of engineering design and engineering management. The curricula can be used in the future for developing students' imagination capabilities in concept design and new product development of engineering products.

The remainder of this study is organized as follows: In Section "Literature Review", the concepts of imagination will be introduced. In Section "Research Method", the author will introduce the research methods being used in this research, which include the modified Delphi, the DEMATEL, the DNP, and the GRA. Then, in Section "The GRA Method", the analytic procedure for defining the curricula, will be demonstrated. The major findings, implications, limitations of this research and future research possibilities will be discussed in Section "Discussion". Section "Conclusions" will conclude the whole article with observations, conclusions and recommendations for further study.

LITERATURE REVIEW

Imagination is a basic human instinct. Without imagination, humanity could not have established current technology and civilization. This section will review the literature related to imagination, the differences and relationships between imagination and creativity, imaginative capability, imagination and successful product development, and the evaluation of imagination. The literature review results will serve as the basis to develop a

curriculum for stimulating, developing and enhancing the imagination capabilities in the technology commercialization process.

Imagination

Imagination has classically been defined as “an act or process of forming a conscious idea or mental image of something never before wholly perceived in reality by the one forming the images” (Taylor, 2013). The general definition of imagination is, “Imagination is the ability to think of all things as possible” (Kangas, 2010). Imagination is a creative faculty of the mind; it can be viewed as a vital cognitive capacity for learning because “it permits us to give credence to alternative realities” (Heath, 2008). According to Zivkovic et al. (2015), the more comprehensive explanation sees “imagination as an dimension of reflective thinking that enables us to bring about ideas that not only go beyond what are given but are effective, in the sense that they are likely to transform experience as intended”.

Imagination is a phase in the process of change; it is produced by culture and society, fed by individual experience; but imagination also feeds-forward, changing individual lives and societies. Imagination is a key phase in the process of change precisely because the imagination is not constrained by what is; rather, imagination is freedom; it is a liminal space, a potential space, in which new ideas, alternatives to the status quo, can be explored (Zittoun & Gillespie, 2015). Most contemporary psychologists define the imagination as a higher mental function that involves the synthetic combining of aspects of memories or experiences into a mental construction that differs from past or present perceived reality and may anticipate future reality (Morosini, 2010).

Imagination is one of the most precious cognitive capacities, the total amount of information the brain is capable of retaining at any particular moment. Imagination can enable people to exceed the real experience and foster the substitute feasibilities. Dewey (1910) explained that imagination is an aspect of reflective thinking, something we learn to do, and we learn to do it from and with other people. The reflective thinking capability enables us to create ideas that not only go beyond what is given but also are effective, in the sense that they are likely to transform experience as intended and relate to the locus of control and creative thinking (Norton, 1994). Above scholars point to the power of imagination as the human capacity that enables us to create fresh perspectives of the world; imagination, along with perception, is an important resource for taking up the aesthetic challenge offered by our natural environment (Brady, 1998).

Scholars have tried to classify imagination based on the characteristics of different activities of human imagination. Betts (1916) classified imagination into reproductive imagination and creative imagination. Kunzendorf (1982) further identified both the idealizing-constructing and transforming characteristics of creative imagination. Reichling (1990) proposed the four facets of imagination as intuition, perception, thinking, and feeling. Colello (2007) divided imagination into two aspects, namely, reproductive imagination and creative imagination. Liu and Noppe-Brandon (2009) supported the claim asserted by Kunzendorf, classified imagination capabilities into three categories: (1) the ability to conjure new realities and possibilities; (2) the ability to unfold in the conscious and deliberate, and in the unconscious and intuitive, and (3) the ability to form associations and analogies between objects that previously seemed disconnected. Fettes and Judson (2010) identified eight functional capabilities of imagination, which included grasping regularity, detail, composition, wholes, possibility, struggle, indices, and inconsistency. Fettes categorized these imaginative capabilities into three groups: (1) grasping the coherence and stability of the world; (2) change, variation, and unpredictability; and (3) the role of integration. Recently, W.-S. Lin, Hsu, and Liang (2014) investigated design majors and categorized their imaginative capability into three types: initiating, conceiving, and transforming.

Imagination and Creativity

Imagination is one of the most precious cognitive capacities and can be perceived as the vehicle of active creativity (Gaut, 2003). To exercise the imagination is to be creative (Levitt, 1986). As stated by El-Murad and West (2004), creativity is often described in such terms as "creative thinking" or "ability," "problem solving," "imagination," or "innovation." Furthermore, according to Im and Workman Jr (2004), creativity is important in

marketing strategy since (1) creativity motivates the generation of new ideas, (2) creativity results in product differentiation, which is a critical determinant of a firm's performance and (3) the resource-based theory of the firm suggests that creativity, which is an intangible resource embedded within the firm, can provide a competitive advantage.

Creativity, which has long been considered as an important source of innovation and competitive strength for organization (Udwadia, 1990), refers to the generation of novel and useful ideas concerning products, services, process, and procedures (T. Amabile, 1996; Chen, Chang, & Chang, 2015). Barron and Harrington (1981) stressed that two primary categories of definitions have been used in large bodies of research: (1) creativity as an ability manifested in performance in critical trials (e.g., Silvia et al., 2008); (2) creativity as socially recognized achievement in which there are novel products that one can point to as evidence (e.g., Baer, Kaufman, & Gentile, 2004).

Creativity is an integral and essential part of the engineering design process (Howard et al., 2008). There is no potential for innovation without creativity in design, which is where creative ideas are actually implemented (Mumford and Gustafson, 1988 and Amabile, 1996) and transformed into commercial value (T. M. Amabile, 1997; Mumford & Gustafson, 1988). To emphasize this importance, recent figures were released from the UK treasury concluding that the top innovating companies produced 75% of revenue from products or services that did not exist 5 years ago. Within industry, creativity does not necessarily equate to success. However, based on the above observation, long-term failure is a near certainty without creativity (Howard et al., 2008).

Concerning the relationship between imagination and creativity, Perdue (2003) explained that imagination can be defined as "a creative faculty of the mind." Gaut (2003) also contended that imagination is peculiarly suited to be the vehicle of active creativity. Besides, he held that the creative person imagines various propositions, and believes that it is possible that the next option tried will be the correct solution (Gaut, 2003). Similarly, Craft et al. (2008) proposed that imagination is an agency-focused "possibility thinking". Moreover, Morosini (2010) suggested that imagination could be regarded as the conduit through which the unconscious self would find its way out in the form of creative mental imagery that could drive deliberate actions. In general, imagination is the basis for cultivating creative thinking and, thus, a driving force of innovation (Finke, 1996). Chu and Quek (2013) argued that experience shapes imagination, and imagination contributes to creative activity; if the output of creative activity is "perceived as new, the products of imagination become creative when they enter the cultural world of interaction". Imagination can be used as a semiotic tool of engagement, which is transformative in the sense that learners become more knowledgeable in their thinking (Egan, 2005). Trotman (2006) stated that imagination is an essential human capacity in conducting various activities such as the pursuit of creativity and innovation, the symbolic expression of ideas, and critical thinking. Baskinger and Nam (2006) further explained that designers often engage in activities involving the visualization of ideas, which primarily relies on their imagination.

Imagination and Successful Product Development

Imagination, a creative faculty of the mind (Heath, 2008) and one of the most precious cognitive capacities, can be perceived as the vehicle of active creativity (Gaut, 2003). Creativity has long been considered an important source of innovation and competitive strength for organizations (Udwadia, 1990). Therefore, it is no wonder that by mining some idea generation software(s), the word "new product" retrieves several associated words and phrases such as marketing, imagination, research experiments, and so on (Rangaswamy & Lilien, 1997). According to the research result derived by Stevens, Burley, and Divine (1999), the correlations are positive between profits generated from new product development projects and the degree of creativity of those projects. In general, imagination is the key driver of creativity. Creativity can further drive successful innovation, which can generate profits.

In a typical new product development process, marketing activities play significant roles in the customer need identification, target specification establishment and product concept generation. For example, Ulrich (2003) included customer need identification, target specification establishment, product concept generation, selection and test, etc. in the generic process of new product development. Unfortunately, marketing programs for many

established products fall short in terms of creativity (Andrews & Smith, 1996). Therefore, Theodore Levitt, the Harvard Business School's "guru of marketing", proposed that marketing imagination is the starting point of success in marketing (Levitt, 1986). Concept development and design also play dominant roles in the early stage of the new product development process. In the role of concept creator, product managers need imagination and active, holistic ways of thinking (Zhang & Doll, 2001). Further, according to Luttrupp (2006), design is creative and creativeness is about knowledge, fantasy and imagination (Luttrupp & Lagerstedt, 2006).

Apparently, imagination is the key factor for influencing creativity in product marketing, concept development, and design. Therefore, incorporating product development success and failure measurement factors is essential in evaluating the methods or courses for stimulating imagination. The methods with low relationship to successful development of products are less valuable for engineering students. According to the work by Griffin and Page (1993), the factors for measuring the product development success or failure include customer acceptance measures, financial performance, product level measure, and firm level measure. According to the definition of Griffin and Page (1993), the customer acceptance measure includes customer acceptance, customer satisfaction, and met revenue goals, revenue growth, market share goals, and unit sales goals. The financial performance measure includes break-even time, attain margin goals, attain profitability goals, and IRR/ROI. The product-level measures include development cost, launched on time, product performance level, met quality guidelines, and speed to market. Finally, the firm-level measures include the percentage of sales by new products.

Evaluation of Imagination

Imagination has been assessed in many different ways depending on the requirements of the study in question. The issue of a general assessment measure of imagination is complicated by the various ways in which the concept has been understood (e.g., it has previously been equated with memory, imagery, fantasy, invention or creativity). Some of the common measures that have been used include the numerous types of inkblot tests, textual measures (sentence building, story creation based around certain words, descriptions of imaginary animals, compositions, theme writing), studies of dreams and fantasy, or various scales depending on the definition adopted. However, Liang, Chi-Cheng, Chang, and Li-Jhong (2012) argued that the understandings of imagination and its indicators remain unclear. So far, few studies have clearly discussed how imagination manifests itself, let alone developed an evaluation tool for assessing imagination (Liang et al., 2012). Because of the potential applicability to the profession of educational technology and various fields, some general concepts of imagination must be explained before referring to them, specifically indicators that might be observed or assessed (Liang et al., 2012). According to the work by Lin et al. (2014), the evaluation criteria for imagination capability can be classified as three types: initiating, conceiving, and transforming (W.-S. Lin et al., 2014). The initiating imagination, the ability to productively conjure new possibilities and a structure in consciousness that negotiates and explores between the known and unknown (Folkmann, 2010), can further the imagination capabilities, which include exploration, novelty, and productivity. The conceiving imagination, the capability to grasp mentally the core of a phenomenon utilizing personal intuition and sensibility, and the capability to formulate effective ideas for achieving a goal through concentration and logical dialectics (Cartwright & Noone, 2006), can be divided into concentration, sensibility, intuition, effectiveness, and dialectics. Finally, the transforming imagination, the capability to crystallize abstract ideas and reproduce what is known across different domains and in various situations (Liu & Noppe-Brandon, 2009; Perdue, 2003; Vygotsky, 2004), can further be classified into crystallization and transformation capabilities.

By summarizing the evaluation criteria for imagination capability proposed by W.-S. Lin et al. (2014) and the key factors for measuring the product development success or failure, the aspects and criteria are summarized below in **Table 1**. These aspects and criteria will serve as the basis for developing the analytic framework for curricula that can stimulate imagination capabilities for commercialization of new products. The corresponding symbols for the aspects and criteria are also defined in **Table 1**.

Table 1. Descriptions of Criteria for Evaluating Imagination Capability

Aspects	Criteria	Descriptions
Initiating Imagination (D ₁)	Exploration (C ₁₁)	Exploration includes things captured by terms such as search, variation, risk taking, experimentation, play, flexibility, discovery, innovation (March, 1991). Imagination can be seen as a structure in consciousness that negotiates, exchanges, and explores between the known and unknown (Folkmann, 2010). Exploration is the initial stage of the mental process being proposed by Valett (1983). The process of controlled perceptual exploration takes individuals from a vague appreciation to a detailed understanding of reality (Thomas, 1999). Colello (2007) asserted that imagination allows one to explore, dare, and challenge institutional order, and thus overcome limits.
	Novelty (C ₁₂)	Imagination builds using materials supplied by reality; however, it would be productive from using combinations of concepts that are more removed from reality (Vygotsky, 2004). An imaginative person is good at creating the new possibilities, and able to offer fresh perspectives on what is familiar (Beaney, 2005).
	Productivity (C ₁₃)	Imaginative might be able to come up with original ways of seeing or doing things in a short period (Beaney, 2005). Imagination relates to the start of the design process as either an overall conception of the design as a whole, or a more experimental exploration for details (Folkmann, 2010). Both positions clearly state the success criteria for the design task in terms of productivity (Liang et al., 2012).
Conceiving Imagination (D ₂)	Concentration (C ₂₁)	Development of self-control is related to the ability to create and sustain an imaginative scenario (Vygotsky, 1980). Folkmann (2010) claimed that the process of focusing is open to ongoing reformulation.
	Sensibility (C ₂₂)	All forms of creative imagination imply elements of feelings, which are not merely inner states, but are really "interiorized thoughts" (Scheffler, 2010). Feeling, in terms of imagination, is assigned a cognitive dimension (Reichling, 1990). Even if the construct of the imagination does not correspond to reality, the feelings it evokes are real (Gajdamaschko*, 2005). Sensibility is thus concluded to be an indicator of imagination, which represents the ability for individuals to arouse feeling during the creating process (Liang et al., 2012).
	Intuition (C ₂₃)	Intuition could be defined as an immediate mode of knowing, knowledge gained directly as an insight, or a grasp of the whole (Reichling, 1990). The insight may occur as a leap from the known to the unknown in the manner can also be described: "When old and new jump together, like sparks when the poles are adjusted, there is intuition" (Dewey, 2005). Intuition leads people to test various thoughts, and possibly gain unexpected outcomes (Reiner & Gilbert, 2000). If people utilize more intuitive representations, then their imagination would last longer (Townsend, 2003).
	Effectiveness (C ₂₄)	Imagination is influenced directly by the constitution of end products and confined within certain constraints (Ribot, 1906). Imagination thus could be examined by the inventions' effectiveness. Imagination is goal-oriented, based on prior experiential imagery (Reiner & Gilbert, 2000). A sharp focus in imagination will often be associated with a goal-oriented process that is close to the given requirements as stated by the client (Folkmann, 2010).
	Dialectics (C ₂₅)	DeVries (1988) asserted that imagination goes through a process of abstraction, analysis, and generalization. When discussing the final level of imagination, Reichling (1990) indicates that intuition leaps for the unknown, while reason is continually challenged to find an image that resolves the contradictions with which it is presented. Also, within their imagination, people can 'zoom in and out' to inspect particular imaginary situations, transfer objects, and predict paths of imaginary objects (Reiner & Gilbert, 2000). Therefore, dialectics can be viewed as an indicator of imagination, which represents the ability of individuals to seek improvement through analyzing ideas (Liang et al., 2012).

Table 1 (continued). Descriptions of Criteria for Evaluating Imagination Capability

Aspects	Criteria	Descriptions
Transforming Imagination (D ₃)	Crystallization (C ₃₁)	According to Aristotle, imagination bridges “images” and “ideas,” (Perdue, 2003). In Hegel’s theory of mental activity, imagination connects “abstract properties” and “concrete universals” by law of association (DeVries, 1988). No matter the form, imagination can facilitate people’s abstract ideas into concrete subjects (Ribot, 1906). Vygotsky believed that imaginative activities are crystallized in culture; all objects of common life appear as a crystallization of the imagination (Vygotsky, 2004).
	Transformation (C ₃₂)	The essential element of imagination in the intellectual sphere is the capacity of thinking through analogies (Ribot, 1906). The core principle behind analogy is transformation. Vygotsky and Luria (1994) stressed that the transformation enables children to learn how to control a situation through the use of symbols. Imagination assists people in transferring a function from one object to another that did not previously have such a function. This ability helps people in dealing with unpredictable problems by using existing experiences (Liang et al., 2012).
Design Performance (D ₄)	Customer Acceptance (C ₄₁)	Technology acceptance means an individual’s psychological state toward his or her voluntary use of a particular technology (Gattiker, 1984).
	Financial Performance (C ₄₂)	Griffin and Page (1993) proposed the financial performance measure to include break-even time, attain margin goals, attain profitability goals, and IRR/ROI. Later, Berman proposed that financial performance is operationally defined as return on assets (ROA), computed as the ratio of operating income to total assets (Berman, Wicks, Kotha, & Jones, 1999).
	Product Performance (C ₄₃)	Product performance is a measure of the success of the system developed during the development project (Wallace, Keil, & Rai, 2004). Product performance is a measure of functional aspects of the product (Osteras, Murthy, & Rausand, 2006). To the extent that product performance is more than the sum of component performance or technical specifications, firms need to worry about integrity and thus about integration (Clark & Fujimoto, 1991).
	Program Performance (C ₄₄)	Programs can be defined as collections of related projects (Wysocki, 2013). PMBOK defined a project as a temporary endeavor undertaken to create a unique product, service, or result (Project Management Institute, 2008). Griffin and Page (1993) proposed that the key to understanding a firm’s position vis-a-vis new product development is being able to measure the “success,” or alternatively “failure,” of individual products and overall development programs.
	Firm Performance (C ₄₅)	Design is essentially the application of human creativity to a purpose—to create products, services, buildings, organizations and environments that meet people’s needs; firms that manage design effectively and efficiently attain better performance than those that do not.

RESEARCH METHOD

To construct the analytic framework for deriving factors to evaluate the curriculum that will enhance the new product development imagination capability, this research first reviewed the related research works of social psychology and literature. Next, the DEMATEL method was employed to establish the causal relationships. Then, the DNP was applied to derive the influence weights based on the experts’ perspectives. Finally, the correlations between the criteria as well as the courses were derived using the GRA. In summary, the assessment model consists of four main steps: (1) deriving the requirement by literature review; (2) structuring the causal relationship based on experts’ opinions by using the DEMATEL; (3) deriving the weights versus each criterion by using the DNP; and (4) deriving the grey relationships between the evaluation criteria and the courses.

Modified Delphi Method

The Delphi method was designed by Dalkey and Helmer (1963). After the Delphi method, Murry and Hammons (1995) tried to identify issues and problems that were collected from a group of technology education professionals using the Modified-Delphi Technique. The modified Delphi simplified the step of conducting the first round of a survey and replaced the conventionally adopted open style survey (Sung, 2001). The purpose of the modified Delphi method is to save time, and the experts can focus on research themes, eliminating the need for speculation on the open questionnaire, and to improve the response of the main topic (Y. S. Lee, Huang., & Hsu, 2008; Sung, 2001). In this research, the modified Delphi method was used to summarize the opinions of experts. Those criteria recognized by over two third of experts served as the criteria for evaluating the courses.

The DNP

The DNP, the DEMATEL technique combining with ANP, was proposed by Tzeng (C.-H. Liu, Tzeng, & Lee, 2012). The DEMATEL technique was developed by the Battelle Geneva Institute: (1) to analyze complex “real world problems” dealing mainly with interactive map-model techniques (Gabus & Fontela, 1972); and (2) to evaluate qualitative and factor-linked aspects of societal problems. The DNP advanced the traditional decision-making framework by manipulating the DEMATEL and the ANP individually, in that a single round of survey of experts’ opinions would be enough to resolve a decision-making problem. In comparison to the traditional approach consisting of two rounds of expert opinion surveys, the DNP actually eased the survey procedure. The DEMATEL technique was developed with the belief that the pioneering and proper use of scientific research methods could help to illuminate specific and intertwined phenomena and contribute to the recognition of practical solutions through a hierarchical structure. The DEMATEL technique was developed with the belief that the pioneering and proper use of scientific research methods could help to illuminate specific and intertwined phenomena and contribute to the recognition of practical solutions through a hierarchical structure. DEMATEL has been successfully applied in many situations such as e-business model definitions (Huang & Shyu, 2006; Huang, Tzeng, & Ho, 2010), policy definitions (C.-Y. Huang, J. Z. Shyu, & G. H. Tzeng, 2007), global manufacturing system optimization (Tzeng & Huang, 2012), technology adoption (Huang & Kao, 2012, 2015; Huang, Kao, Wu, & Tzeng, 2013), provider selection (Liao, Wu, Huang, Kao, & Lee, 2014), etc. The ANP is a general form of the analytic hierarchy process (AHP) (Saaty, 1980) which has been used in multi criteria decision making (MCDM) based researches; such ANP based research can derive weights corresponding to each criteria by releasing the restriction of the hierarchical structure defined in the Analytic Hierarchical Process (AHP). The detailed procedures of the DEMATEL method and the DNP method will be introduced in Appendices A and B.

The GRA Method

Since Deng proposed grey theory in 1982 (Julong, 1989), related models have been developed and applied to MCDM problems. Similar to the fuzzy set theory, the grey theory is a feasible mathematical means used to deal with systems analysis characterized by poor information. Fields covered by the grey theory include systems analysis, data processing, modeling, prediction, decision-making and control. The GRA is used to determine the relationship between two sequences of stochastic data in a grey system. The procedure bears some similarity to pattern recognition technology. One sequence of data is called the “reference pattern” or “reference sequence,” and the correlation of the other sequence to the reference sequence is identified (Deng, 1986; Tzeng & Tasur, 1994). When the grey relational coefficient is conducted, we can then derive the grade of grey relation $\gamma(x_0, x_i)$ between the reference and alternative imagination stimulation courses. The detailed procedure of the GRA method will be introduced in Appendix C.

EMPRICAL STUDY

In this article, the authors summarized the courses, which will stimulate, develop and enhance imagination capabilities in concept development, product planning, and product design. At first, the authors invited experts to summarize possible courses and criteria by using the modified Delphi method. After deriving the possible courses

Table 2. Background of Experts

No.	Education	Expertise	Title	Experiences
1	Ph.D.	Industrial Design	Professor	15
2	Ph.D.	Curriculum Design	Professor	15
3	Master	Multimedia Design	Teacher	6
4	Master	Advertisement Design	Teacher	16
5	Ph.D.	Product Design	Associate Professor	22
6	Master	Multimedia Design	Teacher	24
7	Ph.D.	Multimedia Design	Professor	20
8	Ph.D.	Creativity Research	Professor	40
9	Master	Product Design	Professor	23
10	Ph.D.	Technology Management	Professor	21
11	Ph.D.	Psychology	Assistant Professor	5

and criteria, the authors used DEMATEL to derive the key criteria, establish the decision problem structure, and then used the DNP to derive the weight associated with every aspect and criterion. Finally, the authors used GRA to derive the most important courses. The courses can be used to stimulate, develop, and enhance the imagination capabilities of engineering, design, technology management, and innovation management major students.

Enhance the product commercialization courses

In order to define the curricula for enhancing the capabilities in technology commercialization, this study defined a decision-making framework based on MCDM methods. All the possible criteria for evaluating the methods for stimulating imagination were derived based on experts' opinions. The experts were selected from the engineering design fields of industrial design, product development, multimedia and graphic arts communication, or fields related to imagination or creativity education and research. The experts selected included eight university professors and three teachers from vocational high schools. All the experts have more than five years of work experience. Please refer [Table 2](#) for the background of the experts.

At first, the possible aspects and criteria (refer to [Table 1](#)) for evaluating the course modules were derived by using the modified Delphi method introduced in Section "The Modified Delphi Method". According to Takahashi (1993), more than 300 idea generation techniques have been invented around the world (Takahashi, 1993). However, a limited number of methods is popular in the related fields of engineering while other methods are not. Therefore, the methods highly related to product commercialization were derived by using the modified Delphi method based on the experts' opinions. The top 13 methods selected as courses include: TRIZ, product portfolio, QFD, scenario analysis, morphological method, weighted objective method, technology roadmapping, bionics, brainstorming, SCAMPER, objective tree, conjoint analysis, and value engineering. The methods are briefly introduced in [Table 4](#).

The Causal Relationships and Weight Derivations by the DNP

After the derivation of aspects, criteria and possible methods, the influence relationships between aspects and criteria as well as the associated weights were derived by using the DNP. The DEMATEL is a powerful approach that can be used to systematically analyze the relationships among the criteria and aspects. After that, the DEMATEL based Network Process (DNP), a weight derivation method which was developed based on the concepts of ANP, can be leveraged to derive the weights versus each criterion and aspect in accordance with reciprocal influence relations.

First, the DEMATEL was introduced to derive the influence relationships between aspects and criteria based on the opinions provided by the 11 experts. The initial direct-relation matrix A , the normalized matrix N , and the total relations matrix T can be derived by using equations (A1), (A2) and (A3), as well as (A4) respectively (the

equations can be found in Appendix A). The influence relationship network derived according to the matrix T is demonstrated in [Figure 1](#).

$$A = \begin{bmatrix} 0 & 4.556 & 3.889 & 2.889 \\ 4.000 & 0 & 4.222 & 4.222 \\ 3.556 & 3.889 & 0 & 4.000 \\ 3.111 & 3.667 & 3.778 & 0 \end{bmatrix}$$

$$N = \begin{bmatrix} 0 & 0.366 & 0.313 & 0.232 \\ 0.321 & 0 & 0.339 & 0.339 \\ 0.286 & 0.313 & 0 & 0.321 \\ 0.250 & 0.295 & 0.304 & 0 \end{bmatrix}$$

$$T = \begin{bmatrix} 2.586 & 3.109 & 3.046 & 2.866 \\ 2.998 & 3.027 & 3.246 & 3.106 \\ 2.808 & 3.078 & 2.808 & 2.920 \\ 2.632 & 2.898 & 2.874 & 2.518 \end{bmatrix}$$

To derive the causal relationships, we use equations (A5) and (A6) to derive r_i and c_i , which represent the summation of row and column versus the corresponding criteria and aspects. Subsequently, $(r_i + c_i)$ and $(r_i - c_i)$ can be depicted in [Tables 5](#) and [6](#).

Regarding the causal relationships derived, an aspect or criterion is recognized as a cause if $(r_i - c_i)$ is positive. If the corresponding $(r_i - c_i)$ value is negative, the aspect or criterion can be recognized as an effect. Further, the $(r_i + c_i)$ value stands for the strength of the influences being dispatched and received. For the influence relations between the aspects, according to [Table 5](#), the initiating imagination (D_1) and conceiving imagination (D_2) have the highest $(r_i - c_i)$ value compared to the rest of the aspects. That is, these two aspects have significant influences on other aspects. By contrast, the transforming imagination (D_3) and design performance (D_4) have negative values of $(r_i - c_i)$, which means these two aspects are mainly influenced by others.

The causal relationship is demonstrated in [Figure 1](#). This illustration demonstrates that the initiating imagination (D_1) affects the design performance (D_4), and has mutual influence relations with the conceiving imagination aspect (D_2). The conceiving imagination (D_2) influences transforming imagination (D_3) and design performance (D_4). Moreover, the conceiving imagination (D_2) influences itself by a feedback relationship.

Table 3. The Modified Delphi Results

No.	Criteria																			
	D ₁	D ₂	D ₃	D ₄	C ₁₁	C ₁₂	C ₁₃	C ₂₁	C ₂₂	C ₂₃	C ₂₄	C ₂₅	C ₃₁	C ₃₂	C ₄₁	C ₄₂	C ₄₃	C ₄₄	C ₄₅	
1	Agree	Agree	Agree	Agree	Agree	Agree	Agree	Agree	Agree	Agree	Agree	Agree	Agree	Agree	Agree	Agree	Agree	Agree	Agree	Agree
2	Agree	Agree	Agree	Agree	Agree	Agree	Agree	Agree	Disagree	Agree	Agree	Agree	Agree	Agree	Agree	Agree	Agree	Agree	Agree	Agree
3	Agree	Agree	Agree	Agree	Agree	Agree	Agree	Agree	Agree	Agree	Agree	Agree	Agree	Agree	Agree	Agree	Agree	Agree	Agree	Agree
4	Agree	Agree	Agree	Agree	Agree	Agree	Agree	Agree	Agree	Agree	Agree	Agree	Agree	Agree	Agree	Agree	Agree	Agree	Agree	Agree
5	Agree	Agree	Agree	Agree	Agree	Agree	Agree	Agree	Agree	Agree	Agree	Agree	Agree	Agree	Agree	Agree	Agree	Agree	Agree	Agree
6	Agree	Disagree	Agree	Disagree	Agree	Agree	Disagree	Agree	Disagree	Agree	Agree	Disagree	Agree	Agree	Agree	Agree	Disagree	Agree	Agree	Agree
7	Disagree	Disagree	Agree	Disagree	Agree	Agree	Disagree	Agree	Disagree	Agree	Agree	Agree	Agree	Agree	Agree	Disagree	Agree	Disagree	Agree	Agree
8	Agree	Agree	Agree	Agree	Agree	Disagree	Disagree	Disagree	Agree	Agree	Agree	Agree	Agree	Agree	Agree	Agree	Agree	Agree	Agree	Agree
9	Agree	Agree	Agree	Agree	Agree	Agree	Agree	Agree	Agree	Agree	Agree	Agree	Agree	Agree	Agree	Agree	Agree	Agree	Agree	Agree
10	Agree	Agree	Agree	Agree	Agree	Agree	Agree	Agree	Agree	Agree	Agree	Agree	Agree	Agree	Agree	Agree	Agree	Agree	Agree	Agree
11	Agree	Agree	Agree	Agree	Agree	Agree	Agree	Agree	Agree	Agree	Agree	Agree	Agree	Agree	Agree	Agree	Agree	Agree	Agree	Agree
Agree	10	9	11	9	11	10	8	10	8	11	11	10	11	11	11	10	10	10	10	11
Disagree	1	2	0	2	0	1	3	1	3	0	0	1	0	0	0	1	1	1	1	0
Agree%	90.91%	81.28%	100.00%	81.28%	100.00%	90.91%	72.73%	90.91%	72.73%	100.00%	100.00%	90.91%	100.00%	100.00%	100.00%	90.91%	90.91%	90.91%	90.91%	100.00%
Disagree%	9.09%	18.18%	0.00%	18.18%	0.00%	9.09%	27.27%	9.09%	27.27%	0.00%	0.00%	9.09%	0.00%	0.00%	0.00%	9.09%	9.09%	9.09%	9.09%	0.00%

Table 4. Course Modules for Stimulating Imagination Capability

Method	Descriptions
TRIZ (s_1)	TRIZ is a Russian acronym, and its English translation is Theory of Incentive Problem Solving (TIPS). TRIZ helps to analyze problems and pinpoint contradictions, which are later divided into two categories, physical and technical. Different solutions will then be sought.
New Product Portfolio (s_2)	Portfolio management treats R&D investments much like a fund manager in the stock market treats financial investments; it deals with issues such as maximizing the value of the portfolio, hence return on R&D spending; an appropriately balanced portfolio; and a portfolio investment strategy that is aligned with the company's overall business strategy (Cooper, Edgett, & Kleinschmidt, 2001).
QFD (s_3)	The QFD is an integrated planning method that can assure and improve the alignment of elements of design processes with the requirements of customers, as well as it is a managerial philosophy that can help enhance the organizational and managing effects (Yang, Wang, Dulaimi, & Low, 2003). Especially, QFD employs a cross-functional team to plan and design new or improved products or services through a structured and well-documented framework (Karsak, Sozer, & Alptekin, 2003).
Scenario Analysis (s_4)	Scenario development can serve as an aid to planning is focused on developing alternative visions of the future. Visioning exercises typically look farther into the future than other futures methods. Scenario planning has proven to be a disciplined method for imagining possible futures in which decisions may be played out (Schoemaker, 1995), and a powerful tool for asking "what if" questions to explore the consequences of uncertainty.
Morphological Method (s_5)	The morphological method in image processing (Kimori, 2013), which is often used to extract image component, can be used as a scale-dependent roughness measure of gridded DEMs. Morphological methods control the ranges of the local spatial regions by the size of a known shape called structuring element (SE).
Weighted Objective Method (s_6)	The weighted objective method compare the utility values of alternative design proposals, on the basis of performance against differential weighted objectives (Sapuan, Maleque, Hameedullah, Suddin, & Ismail, 2005). In this method, the design objectives were listed and ranked. Relative weight was listed to the objectives; an alternative is to assign relative weight at different levels of an objective tree, so that all weight sum to 1.0; performance parameter or utility values for each objective were established (Sapuan et al., 2005).
Technology Roadmapping (s_7)	A technology roadmap is "a technology planning process based on market needs, which identifies the technological alternatives necessary to satisfy the market requirements or the product requirements and facilitates the selection and development of these technologies (Garcia & Bray, 1997). In addition, it expresses the performance target required for the future and the R&D activities or technology alternatives needed to meet these targets on a temporal axis.
Bionics (s_8)	Bionics is the application of biological methods and systems found in nature to the study and design of engineering systems and modern technology (Grzesiak, Becker, & Verl, 2011).
Brain Storming (s_9)	Brainstorming as an effective means of enhancing the quantity and quality of ideas generated in group settings. Typical brainstorming instructions prompt group members to generate as many ideas as possible, to evaluate uncritically their own ideas before expressing them, to evaluate uncritically other people's ideas when they are expressed, and to improve or combine ideas already suggested (Osborn, 1953).
SCAMPER (s_{10})	Eberle (1996) originated the SCAMPER model as a way of remembering major factors and processes involved in any aspect of creativity (Gladding & Henderson, 2000). The changes that SCAMPER stands for are Substitute, Combine, Adapt, Modify, Put to another use, Eliminate and Reverse (Serrat, 2009).
Objective Tree (s_{11})	According to Pahl and Beitz (1988), the objective tree method offers a clear format for the higher-level objective and the sub-objectives, which is offers a clear format for the higher-level objective and the sub-objectives, which is useful in evaluating goal strategies. The principal or most important key construct occupies the top level. The variables or factors of each key construct occupy the second level. Moreover, the measurement of each variable or factor is on the third level. Finally, the fourth level is for comparing different alternatives.
Conjoint Analysis (s_{12})	Conjoint analysis is grounded in both psychology and economics (McFadden, 1986). Conjoint analysis considers all possible combinations of attribute levels. Conjoint analysis belongs to a class of multivariate research techniques that use participants' choices (e.g., rankings for a set of product configurations) to estimate the underlying attribute relationships, enabling researchers to study preferences (Green & Srinivasan, 1978).
Value Engineering (s_{13})	Value engineering is an organized/systematic approach directed at analyzing the function of systems, equipment, facilities, services, and supplies for the purpose of achieving their essential functions at the lowest life-cycle cost consistent with required performance, reliability, quality, and safety (Kelly, Male, & Graham, 2014).

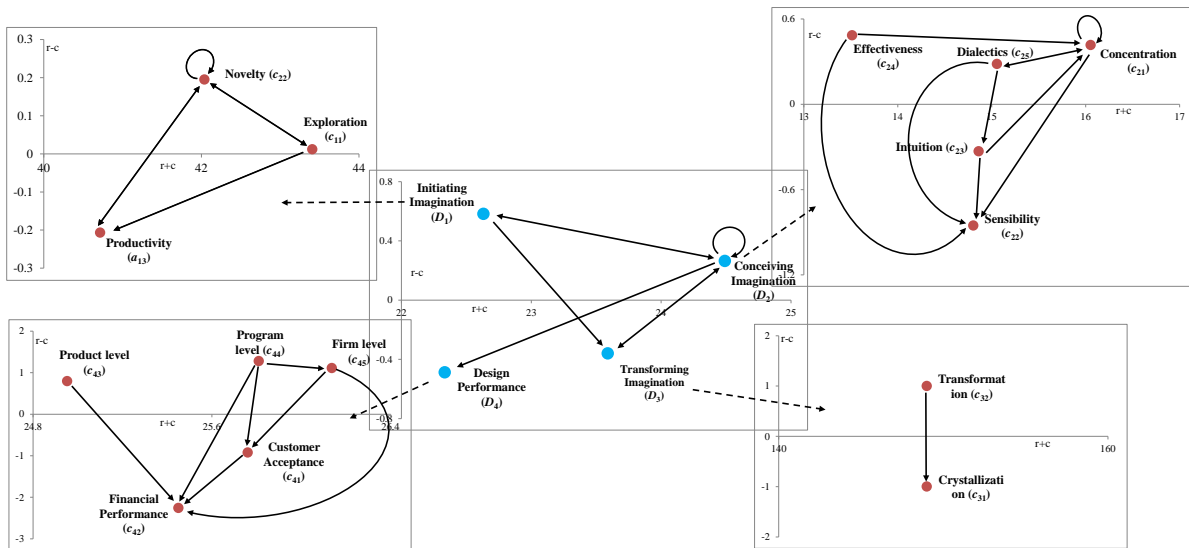

Figure 1. The Influence Relationships Network

Table 6 demonstrates $(r_i + c_i)$ and $(r_i - c_i)$ values versus each criterion. According to Table 6, the $(r_i - c_i)$ value of novelty (c_{12}) is the highest in the initiating imagination (D_1) aspect. In the conceiving imagination (D_2) aspect, effectiveness (c_{24}), concentration (c_{21}), and dialectics (c_{25}) are the criteria with the highest positive $(r_i - c_i)$ values. In the transforming imagination (D_3) aspect, transformation (c_{32}) has the highest $(r_i - c_i)$ value. In the design performance (D_4) aspect, program performance (c_{44}) and firm performance (c_{45}) have the highest $(r_i - c_i)$ values. Specifically, in each aspect, the above-mentioned criteria with positive $(r_i - c_i)$ values generate significant effects on other criteria belonging to that aspect.

Based on the influence relation derived by DEMATEL, we further derived the weights corresponding to the aspects and criteria based on the DNP introduced in Appendix B. The weights can be derived by considering both local weights derived from the influence relations in each aspect, and the corresponding aspect weights derived from the influence relationships between aspects. Therefore, the global weight stands for the real influence weights derived from the local weight. The global weight can be regarded as a priority indicator for ranking these aspects and criteria. The importance versus these aspects and criteria can thus be evaluated and ranked. According to the analytic results derived in Table 7, conceiving imagination (D_2) is the most important aspect versus other aspects. Initiating imagination (D_1) is the least important aspect.

Based on the influence weights versus each aspect and criterion, for the initiating imagination (D_1) aspect, the influential weights versus the criteria can be ranked as exploration (c_{11}) > novelty (c_{12}) > productivity (c_{13}). Likewise, the order of influential weights versus the criteria in the conceiving imagination (D_2) aspect can be ranked as concentration (c_{21}) > sensibility (c_{22}) > intuition (c_{23}) > dialectics (c_{25}) > effectiveness (c_{24}). Subsequently, the order of influential weights versus the criteria in the transforming imagination (D_3) aspect can be ranked as transformation (c_{32}) > crystallization (c_{31}). Finally, the order of influential weights versus the criteria in the design performance (D_4) aspect is financial performance (c_{42}) > customer acceptance (c_{41}) > firm performance (c_{45}) > program performance (c_{44}) > product performance (c_{43}).

Table 5. ($r_i + c_i$) and ($r_i - c_i$) versus each aspect

Aspects	r_i	c_i	$r_i + c_i$	$r_i - c_i$
Initiating Imagination (D_1)	11.607	11.025	22.632	0.583
Conceiving Imagination (D_2)	12.378	12.113	24.491	0.265
Transforming Imagination (D_3)	11.615	11.974	23.589	-0.359
Design Performance (D_4)	10.923	11.411	22.334	-0.488

Table 6. ($r_i + c_i$) and ($r_i - c_i$) versus each criterion

Criteria	r_i	c_i	$r_i + c_i$	$r_i - c_i$
Exploration (C_{11})	21.710	21.698	43.409	0.012
Novelty (C_{12})	21.117	20.922	42.039	0.195
Productivity (C_{13})	20.255	20.462	40.717	-0.207
Concentration (C_{21})	8.235	7.819	16.054	0.416
Sensibility (C_{22})	6.976	7.829	14.805	-0.853
Intuition (C_{23})	7.266	7.596	14.862	-0.331
Effectiveness (C_{24})	7.000	6.515	13.515	0.485
Dialectics (C_{25})	7.670	7.387	15.057	0.283
Crystallization (C_{31})	74.000	75.000	149.000	-1.000
Transformation (C_{32})	75.000	74.000	149.000	1.000
Customer Acceptance (C_{41})	12.419	13.342	25.761	-0.923
Financial Performance (C_{42})	11.596	13.854	25.451	-2.258
Product level (C_{43})	12.874	12.079	24.953	0.796
Program level (C_{44})	13.543	12.267	25.810	1.276
Firm level (C_{45})	13.623	12.514	26.137	1.110

Table 7. The Influence Weights versus Each Aspect and Criterion

Aspect	Weight	Rank	Criteria	Weight	Rank	Global weights
Initiating Imagination (D_1)	0.237	4	Exploration (C_{11})	0.344	1	0.082
			Novelty (C_{12})	0.332	2	0.079
			Productivity (C_{13})	0.324	3	0.077
Conceiving Imagination (D_2)	0.260	1	Concentration (C_{21})	0.211	1	0.055
			Sensibility (C_{22})	0.210	2	0.055
			Intuition (C_{23})	0.204	3	0.053
			Effectiveness (C_{24})	0.176	5	0.046
			Dialectics (C_{25})	0.199	4	0.052
Transforming Imagination (D_3)	0.257	2	Crystallization (C_{31})	0.503	1	0.129
			Transformation (C_{32})	0.497	2	0.128
Design Performance (D_4)	0.245	3	Customer Acceptance (C_{41})	0.208	2	0.051
			Financial Performance (C_{42})	0.216	1	0.053
			Product Performance (C_{43})	0.189	5	0.046
			Program Performance (C_{44})	0.192	4	0.047
			Firm Performance (C_{45})	0.196	3	0.048

Table 8. The Grey Relation Matrix, Grey Grade, and Rank

Methods	Criteria													Grade	Rank			
	Symbol	c ₁₁	c ₁₂	c ₁₃	c ₂₁	c ₂₂	c ₂₃	c ₂₄	c ₂₅	c ₃₁	c ₃₂	c ₄₁	c ₄₂			c ₄₃	c ₄₄	c ₄₅
TRIZ	s ₁	0.080	0.085	0.082	0.027	0.054	0.026	0.015	0.031	0.128	0.126	0.017	0.017	0.015	0.046	0.016	0.767	2
Product Portfolio Theory	s ₂	0.027	0.028	0.027	0.027	0.027	0.035	0.015	0.018	0.128	0.126	0.034	0.052	0.046	0.046	0.047	0.683	4
Quality Function Deployment (QFD)	s ₃	0.080	0.057	0.082	0.054	0.054	0.053	0.045	0.051	0.128	0.126	0.050	0.026	0.046	0.046	0.047	0.946	1
Scenario Analysis	s ₄	0.080	0.043	0.027	0.027	0.036	0.026	0.045	0.031	0.128	0.042	0.050	0.026	0.015	0.046	0.016	0.640	6
Morphological Method	s ₅	0.040	0.043	0.082	0.027	0.054	0.035	0.023	0.018	0.128	0.042	0.025	0.026	0.023	0.023	0.024	0.612	8
The weighted Objective Method	s ₆	0.040	0.043	0.082	0.054	0.027	0.026	0.015	0.018	0.128	0.042	0.025	0.026	0.023	0.031	0.024	0.604	9
Technology Roadmapping	s ₇	0.027	0.028	0.082	0.054	0.054	0.018	0.015	0.018	0.128	0.042	0.050	0.035	0.030	0.046	0.047	0.675	5
Bionics	s ₈	0.080	0.085	0.041	0.018	0.018	0.018	0.045	0.018	0.043	0.042	0.017	0.017	0.015	0.016	0.016	0.488	12
Brain Storming	s ₉	0.080	0.085	0.041	0.027	0.022	0.053	0.023	0.031	0.064	0.042	0.025	0.017	0.023	0.023	0.024	0.580	11
SCAMPER	s ₁₀	0.080	0.043	0.082	0.054	0.054	0.053	0.015	0.018	0.128	0.042	0.050	0.017	0.023	0.023	0.024	0.706	3
Objective Tree	s ₁₁	0.054	0.028	0.027	0.027	0.018	0.026	0.015	0.018	0.043	0.042	0.025	0.017	0.015	0.023	0.016	0.395	13
Conjoint Analysis	s ₁₂	0.054	0.043	0.055	0.036	0.036	0.035	0.015	0.018	0.128	0.042	0.034	0.035	0.030	0.031	0.032	0.622	7
Value Engineering Method	s ₁₃	0.040	0.028	0.041	0.054	0.054	0.026	0.015	0.018	0.128	0.063	0.017	0.035	0.015	0.023	0.024	0.581	10

Determine the Module Courses by Using Grey Relation

Finally, the author introduced the GRA (refer to Appendix C) to derive the module courses which will be most suitable for stimulating, developing and enhancing imagination capabilities in commercialization of technology. First of all, 13 courses and 15 capabilities were filled into the grey relation matrix based on equation (C1). Then, the DNP derived in Section “The Causal Relationships and Weight Derivations by the DNP” was introduced into the GRA based on equation (C4). The grey grades versus each course can be derived accordingly. According to the analytic results, QFD (s_3), TRIZ (s_1), SCAMPER (s_{10}), and the New Product Portfolio Method (s_2) are the courses with the highest grey relationships to the engineering imagination capabilities. The results are demonstrated in [Table 8](#).

DISCUSSION

In the following section, the authors will discuss the rationalities of influence relationships and the derivations of the imagination stimulation courses. Meanwhile, the consistency between the empirical study and past research will be checked and discussed. Further, the differences between the courses selected by considering the new product development success or failure aspect will be discussed to demonstrate the importance of considering the new product development success aspect. Limitations as well as future research possibilities will also be discussed in the final part of this Discussion Section.

The Rationality of the Influence Relationships

In this sub-section, the rationality of the influence relationships will be discussed. For the influence relationships derived by using the DNP, conceiving imagination (D_2) serves as the driver for influencing other aspects. The conceiving imagination (D_2) is influenced by both aspects, which include the initiating imagination (D_1) aspect and the transforming imagination (D_3) aspect. Furthermore, the conceiving imagination (D_2) also served as a mediator between (1) the initiating imagination (D_1) aspect and the design performance (D_4) aspect, as well as (2) the initiating imagination (D_1) aspect and the transforming imagination (D_3) aspect. The influence relationships derived are consistent with the perspectives from Gaut (2003), who argued that the conceiving imagination should be a trigger that would generate positive influences on other aspects of imagination and should be the vehicle of active creativity. Further, the analytic result is also consistent with the research results found by Hsu, Liang, and Chang (2014): both initiating and transforming imagination would generate the mental images formed and shaped by conceiving imagination. As mentioned above, we found that the conceiving imagination (D_2) influences itself through the feedback loop(s). This result demonstrates the self-enforcing effect of the conceiving imagination (D_2) aspect. For instance, if people use more intuitive representations, their conceiving imagination can last longer (Townsend, 2003). This analytic result further demonstrates that the conceiving imagination has significant influences on design performances. Tamer Cavusgil, Calantone, and Zhao (2003) argued that imagination and creativity are the key factors for innovation outcomes and performances. Employees will generate better job performance by using their imagination and creativity. In the research on salespersons, Barker (1999) found that a salesperson would achieve better performance if his/her creativity and imagination were higher. Further, according to the analytic results by Barker, design performance was one of the measurements of creativity and imagination. Thus, the analytic result of this research is consistent with past studies. For above reasons and findings, practitioners can take these research results into account for the imagination cultivation.

Based on the derived influence relationships, there are several possible strategies to enhance imagination. (1) The initiating imagination (D_1) and conceiving imagination (D_2) influence each other. It means that they can enhance each other, the transforming imagination (D_3) will then acquire essential elevation in performance; (2) The design performance (D_4) will be significantly elevated through the improvements of the initiating imagination (D_1) and conceiving imagination (D_2); and (3) all of the imagination enhancement strategies within each aspect are demonstrated as below (see [Table 9](#)) and will also be discussed as below. By these improving strategies, we can understand in the future how to strengthen which imagination capabilities so that the engineering imagination capability in technology commercialization can have a significant elevation.

Table 9. Imagination Enhancement Strategies

Aspect	Strategy
Aspects	$D_1 \rightarrow D_2 \rightarrow D_3$
	$D_1 \rightarrow D_2 \rightarrow D_4$
	$D_2 \rightarrow D_1 \rightarrow D_3$
Initiating Imagination (D_1)	$C_{12} \rightarrow C_{11} \rightarrow C_{13}$
	$C_{11} \rightarrow C_{12} \rightarrow C_{13}$
	$C_{25} \rightarrow C_{21} \rightarrow C_{22}$
Conceiving imagination (D_2)	$C_{24} \rightarrow C_{21} \rightarrow C_{25} \rightarrow C_{23} \rightarrow C_{22}$
	$C_{25} \rightarrow C_{21} \rightarrow C_{22}$
Transforming Imagination (D_3)	$C_{32} \rightarrow C_{31}$
Design Performance (D_4)	$C_{44} \rightarrow C_{45} \rightarrow C_{41} \rightarrow C_{42}$
	$C_{44} \rightarrow C_{41} \rightarrow C_{42}$

We further discuss the influence relationships of criteria within each aspect. For the initiating imagination (D_1) aspect, we found that novelty (c_{12}) directly influences both exploration (c_{11}) and productivity (c_{13}). Exploration (c_{11}) has the direct influences on novelty (c_{12}) and productivity (c_{13}). From the perspective of enhancing initiating imagination, imagination capabilities can be enhanced by following two strategies. In the first strategy, novelty (c_{12}) influences exploration (c_{11}); exploration (c_{11}) further influences productivity (c_{13}). The causal relationships can be expressed as $c_{12} \rightarrow c_{11} \rightarrow c_{13}$. In the second strategy, exploration (c_{11}) influences novelty (c_{12}) while novelty (c_{12}) can further influence productivity (c_{13}). The causal relationships can be expressed as $c_{11} \rightarrow c_{12} \rightarrow c_{13}$.

In the conceiving imagination (D_2) aspect, concentration (c_{21}) influences dialectics (c_{25}), intuition (c_{23}), and sensibility (c_{22}) significantly. Further, based on the results derived by DEMATEL, effectiveness (c_{24}), dialectics (c_{25}), and concentration (c_{21}) will generate significant influence on other criteria. Imagination capabilities can be enhanced by introducing two strategies. In the first strategy, effectiveness (c_{24}) influences concentration (c_{21}); concentration (c_{21}) influences dialectics (c_{25}); dialectic (c_{25}) influences intuition (c_{23}); and then intuition (c_{23}) influences sensibility (c_{22}). The causal relationships can be expressed as $c_{24} \rightarrow c_{21} \rightarrow c_{25} \rightarrow c_{23} \rightarrow c_{22}$. In the second strategy, dialectics (c_{25}) influences concentration (c_{21}); and concentration (c_{21}) influences sensibility (c_{22}). The causal relationships can be expressed as $c_{25} \rightarrow c_{21} \rightarrow c_{22}$. In the transforming imagination (D_3) aspect, crystallization (c_{32}) influences transformation (c_{31}) directly. The imagination enhancement strategy can be expressed as $c_{32} \rightarrow c_{31}$.

Finally, in the design performance (D_4) aspect, according to the analytic results derived by DEMATEL in Section “The Causal Relationships and Weight Derivations by the DNP”, the criteria including program performance (c_{44}), firm performance (c_{45}), and product performance (c_{43}) are categorized as cause criteria that can influence others. The customer acceptance (c_{41}) and financial performance (c_{42}) criteria are categorized as the effect criteria, which are influenced by the cause criteria. Two imagination capability enhancement strategies were derived. In the first strategy, program performance (c_{44}) influences firm performance (c_{45}); firm performance (c_{45}) influences customer acceptance (c_{41}); and then, customer acceptance (c_{41}) influences financial performance (c_{42}). The causal relationships can be expressed as $c_{44} \rightarrow c_{45} \rightarrow c_{41} \rightarrow c_{42}$. Another enhancing strategy in design performance aspects describes program performance (c_{44}) influences customer acceptance (c_{41}) and then, customer acceptance (c_{41}) influences financial performance (c_{42}). The causal relationships can be expressed as $c_{44} \rightarrow c_{41} \rightarrow c_{42}$. The above-mentioned imagination enhancement strategies are clear and easy for real world applications. Based on the above derived results of improving strategies, it will enable students to elevate their imagination in engineering design in the future.

In addition to the causal networks’ derivation and analysis, we derived the influence weights by the DNP method. Concerning the aspect weights, the conceiving imagination (D_2) aspect is the one with the highest influence weight (0.260). The weights associated with the other aspects, transforming imagination (D_3), design performance (D_4), and initiating imagination (D_1), are 0.257, 0.245, and 0.237, respectively. This result demonstrates the dominant role of conceiving imagination on imagination enhancement for technology commercialization. The analytic result

is consistent with the results by previous researchers' works (Hsu et al., 2014; J.-S. Lin, Liang, Chang, & Liang, 2015).

In the initiating imagination (D_1) aspect, exploration (c_{11}) has the highest value (0.344), which implies its relative importance in comparison with other important criteria in the initiating imagination aspect. For product design, the ability to explore and seek the unknown is always indispensable (Colello, 2007). Therefore, enhancing the exploration capability should always be emphasized by courses so that the corresponding capabilities of students can be enhanced. Further, in the conceiving imagination (D_2) aspect, the weights associated with concentration (c_{21}) and sensibility (c_{22}) are 0.211 and 0.210, respectively. These two criteria should be noticeable. Through the causal networks, imagination enhancement strategies have already demonstrated how intuition and sensibility can be enhanced to stimulate, develop and enhance students' imagination capabilities. In the transforming imagination (D_3) aspect, the weight (0.503) associated with crystallization (c_{32}) is higher than that of transformation (c_{31}), which is 0.497. Finally, in the design performance aspect, the influential weights of financial performance, customer acceptance, firm performance, program performance, and product performance are 0.216, 0.208, 0.196, 0.192, and 0.189, respectively. In order to enhance the financial performance (c_{42}) and customer acceptance (c_{41}) from the causal networks, the strategies demonstrated in the form of causal relationships as of $c_{44} \rightarrow c_{45} \rightarrow c_{41} \rightarrow c_{42}$ or $c_{44} \rightarrow c_{41} \rightarrow c_{42}$ can be adopted. The DNP result in design performance corresponding to its causal relationship, the finding implies that customer acceptance (c_{41}) and financial performance (c_{42}) should be crucial than other criteria. In the real world, designing products, financial issues and customer acceptance are often essential concepts (Griffin & Page, 1993). Therefore, these two criteria are recognized as more important in comparison to other criteria in the aspect.

The Rationale for Selecting the Methods for Improving Imagination

Based on the empirical study results, the methods that include QFD (s_3), TRIZ (s_1), SCAMPER (s_{10}), and the New Product Portfolio Method (s_2) are the methods with the highest relationships to the engineering imagination capabilities. In the following section, the rationale for selecting the methods will be discussed. Meanwhile, the consistency between the empirical study results and past research will be discussed.

QFD

For the top-ranking course, the QFD was ranked as the number-one alternative because the QFD method outperforms other methods in almost all aspects, including creative imagination, reproductive imagination and product development success. As the QFD method can fulfill requirements such as customers' satisfaction with products (c_{41}), good responses of product use by customers (c_{43}), tasks execution and development meet with top directors' requests (c_{44}) and product design and development achieve the firms' goal (c_{45}), the method was recognized as the best one to enhance the technology commercialization imagination capability. The analytic results derived based on experts' opinions are consistent with past research.

The QFD outperformed all other methods in all criteria and is related to exploration (c_{11}) and productivity (c_{13}). For exploration (c_1) of the unknown areas of knowledge and experience, the QFD can also facilitate continuous product improvement with emphasis on the impact of organization learning on innovation (Yang et al., 2003). According to Garvin 1993 (Garvin, 1985), this organizational learning is associated with an organization's ability to explore the unknown and to identify and pursue novel solutions (Ahire & Dreyfus, 2000). For novelty (c_{12}), albeit the QFD outperformed most methods, the experts' opinions were that TRIZ, Bionics, and Brainstorming could bring more novel ideas

For productivity, Politis (2005) has verified the positive correlations between each of the QFD constructs (i.e. QFD strategic planning, customer and market focus, QFD information and analysis, human resources focus on QFD, top management commitment to QFD, QFD training to supervisors, and worker-supervisor collaboration in QFD efforts) will be positively related to productivity.

In the reproductive imagination aspect, from the aspect of crystallization (c_{31}), the QFD helps to analyze customer's requirements systematically and transform them properly into the appropriate product features (Büyüközkan, Feyzioglu, & Ruan, 2007). The method outperforms other methods in expressing abstract ideas by using concrete examples. From the aspect of transformation, QFD can transfer ideas to multiple fields of tasks. According to Bossert (1991), QFD is a method to transform user demands into design quality, to deploy the functions forming quality, and to deploy methods for achieving the design quality into subsystems and component parts.

Finally, in the product development success aspect, for fulfilling customers' satisfaction with products (c_{41}), S. Lee and Sai On Ko (2000) argued that the main goal of QFD is to increase customers' satisfaction by improving their own quality and by exciting the customer through innovation. Further, Juan et al. mentioned that the QFD was a quality management method for converting the customer's needs into design (Juan, Perng, Castro-Lacouture, & Lu, 2009). For good responses of product use by customers (c_{43}), Griffin and Hauser (1993) mentioned that the QFD was a total-quality-management process in which the "voice of the customer" was deployed throughout the R&D, engineering, and manufacturing stages of product development. Ermer (1995) argued that the QFD was a better tool to understand customers' needs. Many other scholars have also reached the same conclusion that the QFD could bring customers' voices, no matter good response (c_{43}) or bad mouths into the organization.

TRIZ

TRIZ was recognized as a powerful systematic innovation tool. For some, TRIZ is a powerful design methodology; others use it as creative imagination booster and a few others use it as a tool to overcome deadlock situations faced in technical progress (Kwatra & Salamatov, 2012). In this research, TRIZ was also recognized as a useful tool for stimulating imagination capability for commercializing a technology from the first and the third aspects.

For the first creativity imagination aspect, TRIZ outperformed other methods in all criteria, including exploration (c_{11}), novelty (c_{12}), and productivity (c_{13}). According to Souchkov (2007), the inventive principles of TRIZ can serve as triggers to activate our creative imagination. The entire problem-solving process being guided by TRIZ tools directs the problem solver to explore solutions in directions that have previously been proven successfully (Chai, Zhang, & Tan, 2005). Therefore, TRIZ can serve as a feasible and efficient tool for exploring unknown areas of knowledge and experience, which have already been uncovered and proven successfully in other fields (c_{11}). For the novelty (c_{12}) criterion, the viewpoint is consistent with past research. Okudan, Ogot, and Shirwaiker (2006) reported that the introduction of TRIZ to first-year engineering students helped design teams to generate more feasible design concepts, and more unique designs than students who did not learn TRIZ. TRIZ has been recognized by scholars as a tool in enhancing productivity. The experts' opinions further supported the viewpoint. Ruchti and Livotov (2001) argued that TRIZ-based thinking methods can improve both the efficiency and effectiveness of decision making in organizations. Schweizer (2002) argued that the more one uses TRIZ, the more one will integrate TRIZ methodology with other problem solving methodologies, enhancing their effectiveness. According to Savransky (2000), many Fortune 500 companies have cited a phenomenal increase in productivity, and they credit TRIZ for the breakthrough ideas and quality solutions to tough engineering problems as fueling that increase. Apparently, TRIZ also has been widely recognized by scholars as a tool to enhance effectiveness and further productivity.

For the third aspect, crystallization or expressing abstract ideas by using concrete examples (c_{31}), according to a comparison of TRIZ with other innovation methodologies, including brain storming, 5W1H, bionic association, combination method, reverse innovation, and technology transplant, translating an idea into practice is easy for TRIZ due to its scientific characteristics (Gao, Huang, & Ma, 2005). The summarization by Gao et al. (2005) is consistent with the results of our research. Further, TRIZ outperformed other tools in cross industry innovations (c_{32}). The analytic results are consistent with past research. Chai et al. (2005) observed that through the analysis of more than 2 million patents, a number of innovation patterns and laws of ideality were identified by Altshuller, Shulyak, and Rodman (1997), the inventors of TRIZ. TRIZ reveals the following characteristics: problems and

solutions repeated across industries and sciences; patterns of technical evolution repeated across industries and sciences; and innovations using scientific effects outside the field where they were developed (Chai et al., 2005). According to Tan, Ma, Yang, and Sun (2008), the obstacle for idea generation for designers in fuzzy front end (FFE) is the difficulty in applying knowledge in different fields. TRIZ and computer-aided innovation systems (CAIs) which are TRIZ-based software systems with a knowledge base, provide a framework for knowledge application in different fields. The analytic result is consistent with the work by Enkel and Gassmann (2010): mostly, cross-industry innovation leads to technological breakthroughs; this could be because technological patents or function descriptions are easier to find through patent analysis or problem-solving methods like TRIZ than solutions leading to market breakthroughs. Apparently, TRIZ can serve as an efficient tool to innovate cross industries.

Finally, the reason about why the TRIZ cannot be ranked by experts as the number-one method showed that TRIZ is comparatively weaker in real-world applications. One of the most significant drawbacks of TRIZ is the weak application in achieving design success (D_4) and the corresponding criteria ($c_{41}, c_{42}, \dots, c_{45}$) belonging to this aspect. The experts' opinions were consistent with earlier works criticizing the weakness of TRIZ. According to Zlotin et al. (1999), basic TRIZ concepts such as ideality, contradictions and the systems approach were fully applicable to non-technical problems and situations. Analytical tools and the psychological operators were directly applicable and easily modifiable to accommodate non-technical applications, while knowledge-based tools required some process of abstraction and generalization away from their technology-centric origins (Ilevbare, Probert, & Phaal, 2013). Still it is argued by some that if it were applied appropriately, TRIZ would be capable of providing useful outcomes in practically every field (Rutitsky, 2010).

SCAMPER

SCAMPER has widely been recognized by various scholars (Clarkson, 2003; Eberle & Weber, 1990; Mijares-Colmenares, Masten, & Underwood, 1993) as an efficient method for creative imagination development. According to C.-L. Lin, Hong, Hwang, and Lin (2006), SCAMPER was identified as an applicable technique to processes characterized by knowledge background of participants, high differences among participants, availability of information, democratic process in meeting, constructive dialogues, or need for elaboration of ideas. This is consistent with our analytic result that SCAMPER leads most other methods in the first aspect, creativity (D_1). However, SCAMPER is not without limitations and was ranked only in third place due to the comparatively lower grey coefficients in the second aspect, conceiving imagination, in criteria effectiveness (c_{24}) and dialectics (c_{25}) and in the fourth aspect, achieving design success (D_4) and the corresponding criteria (c_{42}, \dots, c_{45}) belonging to this aspect.

According to the Delft Design Guide by Van Boeijen, Daalhuizen, Van Der Schoor, and Zijlstra (2014), the SCAMPER method might suggest that by applying the seven heuristics (Substitute, Combine, Adapt, Modify, Put to another use, Eliminate and Reverse), creativity is guaranteed. This is not the case, as a lot depends upon the designer use of the heuristics. Therefore, the SCAMPER method is not suitable for untrained designers. The observation is consistent with the analytic results that SCAMPER was ranked lower. Most engineering students or students belonging to other academic fields should be classified as untrained designers. Therefore, unexperienced students lack new ideas, which can lead by intuition (c_{24}), lack of sensibility to help the students imagine by arousing personal feelings (c_{25}). Of course, the students without experience are not flexible in their thinking and can transfer ideas to multiple fields of tasks (c_{32}). Finally, some shortages of SCAMPER, summarized by Gladding and Henderson (2000), include the mechanical usage, shortsighted and uncreative users, as well as the inhibition of the flow of creativity of users because they became dependent on SCAMPER or other shortcuts to fostering change, thereby failing to draw on their own experience, expertise, or intuition. These disadvantages may hinder the users' imagination capability, creativity, the design performance (D_4) and the successful commercialization of technology.

Utilizations of the Finding to Practical Implications

In this sub-Section, substantial suggestions for practitioners based on the findings will be summarized based on both the influence relations and the Grey relationships being derived and discussed in Sections “The Causal Relationships and Weight Derivations by the DNP”, “Determine the Module Courses by Using Grey Relation” and Sections “The Rationality of the Influence Relationships”, “The Rationale for Selecting the Methods for Improving Imagination”.

At first, based on the imagination enhancement strategies being summarized in **Table 9**, for the capabilities belonging to the initiating imagination aspect (D_1), based on the influence relationship $c_{12} \rightarrow c_{11} \rightarrow c_{13}$, we conclude that an enhancement in novelty (c_{12}) can further influence exploration (c_{11}) and then, productivity (c_{13}). Meanwhile, based on $c_{11} \rightarrow c_{12} \rightarrow c_{13}$, an enhancement in exploration (c_{11}) can further influence novelty (c_{12}) and then, productivity (c_{13}). Therefore, students’ initiating imagination can be enhanced base on the influence relationships as well as the highly-correlated methods to the capabilities c_{11} and c_{12} . According to results of the Grey relation analysis being demonstrated in **Table 8**, the methods with the highest Grey coefficients with exploration (c_{11}) and novelty (c_{12}) are TRIZ, Bionics and Brain Storming. That is, imagination capabilities of the engineering students who are insufficient in these two capabilities can be enhanced by such methods.

The capabilities belonging to the conceiving imagination aspect (D_2) can be enhanced by the influence relationships $c_{25} \rightarrow c_{21} \rightarrow c_{22}$ and $c_{24} \rightarrow c_{21} \rightarrow c_{25} \rightarrow c_{23} \rightarrow c_{22}$. Therefore, students’ initiating imagination can be enhanced base on the influence relationships as well as the highly-correlated methods to the capabilities c_{24} and c_{25} . According to results of the Grey relation analysis being demonstrated in **Table 8**, the methods with the highest Grey coefficients with effectiveness (c_{24}) are QFD, scenario analysis, and Bionics while the methods with higher Grey coefficients with dialectics (c_{25}) are QFD, scenario analysis and brain storming. Engineering students who are insufficient in these two capabilities can be enhanced by these methods.

In the transforming imagination aspect (D_3), engineering students’ imagination capabilities can be enhanced by TRIZ, product portfolio theory and the QFD since the three methods have the highest Grey correlation coefficients with the crystallization (c_{32}) capability, which can influence transformation (c_{31}) directly ($c_{32} \rightarrow c_{31}$).

Finally, in the design performance aspect (D_4), the methods which include TRIZ, product portfolio theory, QFD, scenario analysis and technology roadmapping can be used to enhance program Performance (c_{44}), which can further influence other capabilities through the casual relationships, $c_{44} \rightarrow c_{45} \rightarrow c_{41} \rightarrow c_{42}$ and $c_{44} \rightarrow c_{41} \rightarrow c_{42}$.

Hence, in the real-world applications, the engineering students’ imagination capabilities can be evaluated based on designs of technology or new product development plans by using the aspects and criteria being summarized in **Table 9**. Based on the evaluation results, the insufficient imagination capabilities can be enhanced by using the methods which are closely related to the capabilities in each causal relationship being discussed in this sub-Section. For example, if the students are asked to design the shell of a portable device (e.g. a mobile phone), and designs are evaluated by experts as being short of transformation (c_{31}) capability, the students can introduce the TRIZ, product portfolio, and the QFD method to enhance the crystallization (c_{32}) capability, and then influence the transformation (c_{31}) capability.

A Comparison between Inclusion versus Exclusion of the Design Performance Aspect and the Derived Courses

Since the authors aim to evaluate the impact of the product development success and failure aspect as well as the corresponding criteria, the aspect and criteria are removed to demonstrate the differences. To demonstrate the differences by using the aspects which have already been verified as feasible by earlier works, (e.g., W.-S. Lin et al., 2014), the authors removed the product development success aspect, and derived the influence relationship between the aspects and criteria, the weights being associated with the aspects and criteria, as well as the grey grades corresponding to the methods that can stimulate the imagination capabilities.

Table 10. Weights being Associated with the Imagination Capabilities

Criteria	C ₁₁	C ₁₂	C ₁₃	C ₂₁	C ₂₂	C ₂₃	C ₂₄	C ₂₅	C ₃₁	C ₃₂
Weight	0.080	0.085	0.082	0.054	0.054	0.052	0.045	0.051	0.128	0.126

Table 11. The Grey Relation Matrix, Grey Grade, and Rank

Methods	Criteria												Grade	Rank
	Symbol	C ₁₁	C ₁₂	C ₁₃	C ₂₁	C ₂₂	C ₂₃	C ₂₄	C ₂₅	C ₃₁	C ₃₂			
TRIZ	S ₁	0.0804	0.0852	0.0823	0.0271	0.054	0.0262	0.015	0.0314	0.1277	0.126	0.6553	2	
Product Portfolio Theory	S ₂	0.0268	0.0284	0.0274	0.0271	0.027	0.035	0.015	0.0178	0.1277	0.126	0.4581	11	
Quality Function Deployment (QFD)	S ₃	0.0804	0.0568	0.0823	0.0541	0.054	0.0525	0.0451	0.0511	0.1277	0.126	0.7299	1	
Scenario Analysis	S ₄	0.0804	0.0426	0.0274	0.0271	0.036	0.0262	0.0451	0.0314	0.1277	0.042	0.4859	5	
Morphological Method	S ₅	0.0402	0.0426	0.0823	0.0271	0.054	0.035	0.0225	0.0178	0.1277	0.042	0.4911	4	
The weighted Objective Method	S ₆	0.0402	0.0426	0.0823	0.0541	0.027	0.0262	0.015	0.0178	0.1277	0.042	0.4749	6	
Technology Roadmapping	S ₇	0.0268	0.0284	0.0823	0.0541	0.054	0.0175	0.015	0.0178	0.1277	0.042	0.4655	9	
Bionics	S ₈	0.0804	0.0852	0.0411	0.018	0.018	0.0175	0.0451	0.0178	0.0426	0.042	0.4077	12	
Brain Storming	S ₉	0.0804	0.0852	0.0411	0.0271	0.0216	0.0525	0.0225	0.0314	0.0638	0.042	0.4677	7	
SCAMPER	S ₁₀	0.0804	0.0426	0.0823	0.0541	0.054	0.0525	0.015	0.0178	0.1277	0.042	0.5684	3	
Objective Tree	S ₁₁	0.0536	0.0284	0.0274	0.0271	0.018	0.0262	0.015	0.0178	0.0426	0.042	0.2981	13	
Conjoint Analysis	S ₁₂	0.0536	0.0426	0.0548	0.0361	0.036	0.035	0.015	0.0178	0.1277	0.042	0.4606	10	
Value Engineering Method	S ₁₃	0.0402	0.0284	0.0411	0.0541	0.054	0.0262	0.015	0.0178	0.1277	0.063	0.4676	8	

Based on the analytic results, the weights associated with the criteria are shown in the following **Table 10**. According to the grey grades demonstrated in **Table 11**, the courses with the highest grey grades, which include QFD (S₃), TRIZ (S₁), and SCAMPER (S₁₀), are similar. However, the rankings of some methods change significantly (refer **Table 12**). On one hand, the new product portfolio method was downgraded from 4th place to 11th place. The ranking of technology roadmapping was also downgraded significantly from 5th place to 9th place. On the other hand, the Morphological Method and the brain storming method were upgraded to 4th place and 7th place, respectively. That means, by considering the aspects that had been recognized as important by earlier research, the methods that had already been recognized by scholars as efficient in enhancing the imagination capabilities will be ranked higher. However, the methods that are closely related to new product planning and development, e.g. the new product portfolio and the technology roadmapping method, were recognized as less important methods. The analytic result implies that the incorporation of the product development success aspect is essential to define the curricula for enhancing the imagination capability of engineering students.

Limitations and Future Work

In this research, the experts were invited for deriving the aspects and criteria. Albeit some existing researches have provided valuable insights for course selection for developing creativity, to the best of our knowledge, this research is the first attempt to derive courses for enhancing imagination capabilities via an MCDM based systematic approach, which considers the influence relationships between criteria. The experts who are responsible for engineering education can provide valuable insights. However, the total number of available Taiwanese experts is fewer than 30. The statistical analysis based approaches, including exploratory and confirmatory factor analysis, are not suitable, as they require more than 30 experts to fulfill the minimum sample number requirements. Therefore, the expert system based approach is more feasible and reasonable for this specific problem.

Meanwhile, the experts are mainly from the industrial design and engineering/technology management related fields with practical product design and development experience. Therefore, the result may be controversial. From this aspect, future research may include studies based on the opinions from faculties of other engineering fields, e.g. electrical engineering, computer engineering/science, mechanical engineering, etc. The studies may derive different course for stimulating imagination capabilities of students belonging to various academic fields.

Table 12. Comparisons of the Ranking of the Methods

Method	DP	w/o DP	Method	DP	w/o DP
TRIZ	2	2	Bionics	12	12
Product Portfolio Theory	4	11	Brain Storming	11	7
QFD	1	1	SCAMPER	3	3
Scenario Analysis	6	5	Objective Tree	13	13
Morphological Method	8	4	Conjoint Analysis	7	10
The weighted Objective Method	9	6	Value Engineering	10	8
Technology Roadmapping	5	9			

Remark: "DP" means the ranking of alternatives with the consideration of the design performance aspect; w/o DP means the ranking without considering the design performance aspect.

The unavailability of female experts was another limitation. According to a recent survey by Australian Council of Learned Academies, the number of Taiwanese female academic staff was significantly less than the male one; only around 20 percent of STEM faculties were female (Marginson et al., 2013). This phenomenon is especially significant in most engineering domain. In most engineering programs, the percentage of female faculty can be much lower than 20 percent. Therefore, inviting sufficient experts for opinion provisions was not easy. In the future, surveys on female experts' opinions regarding to the criteria and curriculums influencing engineering imagination capabilities can be a very interesting topic. Since countries generally are grappling with the issue of under-representation of women and girls in STEM (Marginson et al., 2013), and pursue a variety of gender equity policies and strategies to address the engineering imagination related issues will be another important topic.

Experiments on teaching the same methods to engineering students from various academic fields may also bring different results. Other possible research might include the study of the factors influencing engineering imagination capabilities based on empirical studies of larger economies by using the exploratory or confirmatory factor analyses. The results derived based on experts' opinions by MCDM methods and the results derived based on the statistical analyses (e.g., the covariance based structure equation model or the partial least squares method) could further be compared and studied. Other possible studies include the application of the analytical framework in other economies or industries.

Finally, how the methods can enhance specific imagination capabilities of engineering students can be experimented. As discussed in Section "Utilizations of the Finding to Practical Implications", specific imagination capabilities can be enhanced based on the strategies being summarized in Table 9 as well as the methods highly correlated to the capabilities (refer to Table 8). The feasibility of such methods in enhancing imagination capabilities should further be verified by teaching experiment.

CONCLUSIONS

Imagination is a basic human instinct. With plenty of imagination as a source of creativity, both innovation and creativity are needed to produce rich and continuous innovations that contribute to the country's economic boom. Without imagination, humanity cannot sustain the current technology and civilization. In engineering design and technology industries, technology commercialization, technology development, new products (or improved products), manufacturing and marketing processes or equipment related to (technology commercialization) activity, refer to the management and idea generation have strong relationships with imagination. Therefore, the imagination enhancement will be pretty important. Albeit important, few works have explored an appropriate curriculum for developing students' imagination for technology commercialization. In this work, an MCDM-based analytic framework was developed. Courses including the QFD, TRIZ, and SCAMPER were ranked as the most important courses. In the future, the curriculum can be applied to enhance engineering students' imagination capabilities in technology commercialization.

ACKNOWLEDGEMENTS

The authors gratefully acknowledge the long-term advice by Distinguished Chair Professor, Dr. Gwo-Hshiung Tzeng on the research methods manipulations and analytic framework development. The authors also appreciate the efforts by Tze-Chern Lin, Bo-Wen Hsiao, Hsiao-Li Huang, Yo-Ning Chang, Jun-Jay Yang, and Wen-Fong Shih for their help in collecting literature and paper formatting. In addition, the support of the Minister of Science and Technology, Taiwan through grant numbers NSC100-2221-E-003-023 and NSC102-2511-S-003 -061-MY3 are greatly appreciated.

REFERENCES

- Ahire, S. L., & Dreyfus, P. (2000). The impact of design management and process management on quality: an empirical investigation. *Journal of Operations Management*, 18(5), 549-575.
- Altshuller, G., Shulyak, L., & Rodman, S. (1997). *40 Principles: TRIZ keys to innovation* (Vol. 1): Technical Innovation Center, Inc.
- Amabile, T. (1996). *Creativity in context*: Westview press.
- Amabile, T. M. (1997). Motivating creativity in organizations: On doing what you love and loving what you do. *California management review*, 40(1), 39-58.
- Andrews, J., & Smith, D. C. (1996). In search of the marketing imagination: Factors affecting the creativity of marketing programs for mature products. *Journal of Marketing Research*, 174-187.
- Büyükközkcan, G., Feyzioğlu, O., & Ruan, D. (2007). Fuzzy group decision-making to multiple preference formats in quality function deployment. *Computers in Industry*, 58(5), 392-402.
- Baer, J., Kaufman, J. C., & Gentile, C. A. (2004). Extension of the consensual assessment technique to nonparallel creative products. *Creativity Research Journal*, 16(1), 113-117.
- Barczak, G., Griffin, A., & Kahn, K. B. (2009). Perspective: trends and drivers of success in NPD practices: results of the 2003 PDMA best practices study*. *Journal of Product Innovation Management*, 26(1), 3-23.
- Barker, A. T. (1999). Benchmarks of successful salesforce performance. *Canadian Journal of Administrative Sciences/Revue Canadienne des Sciences de l'Administration*, 16(2), 95-104.
- Barron, F., & Harrington, D. M. (1981). Creativity, intelligence, and personality. *Annual review of psychology*, 32(1), 439-476.
- Baskinger, M., & Nam, K.-C. (2006). *Visual narratives: the essential role of imagination in the visualization process*. Paper presented at the Proceedings of the 2006 Asia-Pacific Symposium on Information Visualisation-Volume 60.
- Beaney, M. (2005). *Imagination and creativity*: Open University Milton Keynes, UK.
- Berman, S. L., Wicks, A. C., Kotha, S., & Jones, T. M. (1999). Does stakeholder orientation matter? The relationship between stakeholder management models and firm financial performance. *Academy of Management journal*, 42(5), 488-506.
- Betts, G. H. (1916). *The mind and its education*: Appleton.
- Bossert, J. L. (1991). *Quality function deployment: a practitioner's approach*: ASQC Quality Press.
- Brady, E. (1998). Imagination and the aesthetic appreciation of nature. *The Journal of Aesthetics and Art Criticism*, 56(2), 139-147.
- Calantone, R., Di Benedetto, C. A., & Rubera, G. (2012). Launch timing and launch activities proficiency as antecedents to new product performance. *Journal of Global Scholars of Marketing Science*, 22(4), 290-309.
- Cartwright, P., & Noone, L. (2006). Critical Imagination: A Pedagogy for Engaging Pre-Service Teachers in the University Classroom. *College Quarterly*, 9(4), n4.
- Chai, K.-H., Zhang, J., & Tan, K.-C. (2005). A TRIZ-based method for new service design. *Journal of Service Research*, 8(1), 48-66.
- Chen, M.-H., Chang, Y.-Y., & Chang, Y.-C. (2015). Exploring individual-work context fit in affecting employee creativity in technology-based companies. *Technological Forecasting and Social Change*, 98, 1-12.

- Chu, S., & Quek, F. (2013). *Maia: A methodology for assessing imagination in action*. Paper presented at the CHI 2013 Workshop on Evaluation Methods for Creativity Support Environments.
- Clark, K. B., & Fujimoto, T. (1991). *Product Development Performance: Strategy, Organization, and Management in the World Auto Industry*: Harvard Business School Press.
- Clarkson, A. (2003). A curriculum for the creative imagination. *Creativity and music education*, 52-76.
- Colello, S. M. G. (2007). Imagination in children's writing: How high can fiction fly. *Notandum*, 10(14), 5-15.
- Cooper, R. G., Edgett, S. J., & Kleinschmidt, E. J. (2001). *Portfolio management for new products*: Basic Books.
- Craft, A., Chappell, K., & Twining, P. (2008). Learners reconceptualising education: widening participation through creative engagement? *Innovations in Education and Teaching International*, 45(3), 235-245.
- Dalkey, N., & Helmer, O. (1963). An experimental application of the Delphi method to the use of experts. *Management Science*, 9(3), 458-467.
- Deng, J. (1986). Grey prediction and decision. *Huazhong University of Science and Technology, Wuhan, China*.
- DeVries, W. (1988). Hegel's theory of mental activity.
- Dewey, J. (1910). The influence of Darwin on philosophy. *The influence of Darwin on philosophy and other essays*, 1-19.
- Dewey, J. (2005). *Art as experience*: Penguin.
- Doiron, R., & Egan, K. (1993). Imagination in teaching and learning: The middle school years: JSTOR.
- Eberle, B. (1996). *Scamper on: Games for imagination development*: Prufrock Press Inc.
- Eberle, B., & Weber, J. K. (1990). *Scamper on: For Creative Imagination Development*: Hawker Brownlow Education.
- Egan, K. (2005). An imaginative approach to teaching. *San Francisco*.
- El-Murad, J., & West, D. C. (2004). The definition and measurement of creativity: what do we know? *Journal of Advertising Research*, 44(02), 188-201.
- Enkel, E., & Gassmann, O. (2010). Creative imitation: exploring the case of cross-industry innovation. *R&D Management*, 40(3), 256-270.
- Ermer, D. S. (1995). Using QFD becomes an educational experience for students and faculty. *Quality Progress*, 28(5), 131.
- Fettes, M., & Judson, G. (2010). Imagination and the cognitive tools of place-making. *The Journal of Environmental Education*, 42(2), 123-135.
- Finke, R. A. (1996). Imagery, creativity, and emergent structure. *Consciousness and cognition*, 5(3), 381-393.
- Folkmann, M. N. (2010). *Enabling creativity. Imagination in design processes*. Paper presented at the DS 66-2: Proceedings of the 1st International Conference on Design Creativity (ICDC 2010).
- Gabus, A., & Fontela, E. (1972). *World Problems, an Invitation to Further Thought Within the Framework of DEMATEL*. Geneva, Switzerland: Batelle Geneva Research Center.
- Gajdamaschko*, N. (2005). Vygotsky on imagination: Why an understanding of the imagination is an important issue for schoolteachers. *Teaching Education*, 16(1), 13-22.
- Gao, C., Huang, K., & Ma, F. (2005). Comparison of innovation methodologies and TRIZ. *The TRIZ Journal*.
- Garcia, M. L., & Bray, O. H. (1997). *Fundamentals of technology roadmapping*: Citeseer.
- Garvin, D. A. (1985). Building a learning organization. *Org Dev & Trng*, 6E (Iae), 274.
- Gattiker, U. (1984). Managing computer-based office information technology: a process model for management. *Human Factors in Organizational Design, North-Holland, Amsterdam, The Netherlands*, 1, 395-403.
- Gaut, B. (2003). Creativity and imagination. *The creation of art*, 148-173.
- Gladding, S. T., & Henderson, D. A. (2000). Creativity and family counseling: The SCAMPER model as a template for promoting creative processes. *The Family Journal*, 8(3), 245-249.
- Green, P. E., & Srinivasan, V. (1978). Conjoint analysis in consumer research: issues and outlook. *Journal of consumer research*, 103-123.
- Griffin, A., & Hauser, J. R. (1993). The voice of the customer. *Marketing science*, 12(1), 1-27.

- Griffin, A., & Page, A. L. (1993). An interim report on measuring product development success and failure. *Journal of Product Innovation Management*, 10(4), 291-308.
- Grzesiak, A., Becker, R., & Verl, A. (2011). The bionic handling assistant: a success story of additive manufacturing. *Assembly Automation*, 31(4), 329-333.
- Heath, G. (2008). Exploring the imagination to establish frameworks for learning. *Studies in Philosophy and Education*, 27(2-3), 115-123.
- Hoidn, S., & Kärkkäinen, K. (2014). Promoting skills for innovation in higher education: A literature review on the effectiveness of problem-based learning and of teaching behaviours: OECD Publishing.
- Howard, T. J., Culley, S. J., & Dekoninck, E. (2008). Describing the creative design process by the integration of engineering design and cognitive psychology literature. *Design studies*, 29(2), 160-180.
- Hsu, Y., Liang, C., & Chang, C.-C. (2014). The mediating effects of generative cognition on imagination stimulation. *Innovations in Education and Teaching International*, 51(5), 544-555.
- Huang, C.-Y., & Shyu, J. Z. (2006). Developing e-commerce business models for enabling silicon intellectual property transactions. *International Journal of Information Technology and Management*, 5(2/3), 114-133.
- Huang, C.-Y., Shyu, J. Z., & Tzeng, G.-H. (2007). Reconfiguring the innovation policy portfolios for Taiwan's SIP Mall industry. *Technovation*, 27(12), 744-765. doi:10.1016/j.technovation.2007.04.002
- Huang, C.-Y., Shyu, J. Z., & Tzeng, G. H. (2007). Reconfiguring the Innovation Policy Portfolios for Taiwan 's SIP Mall Industry. *Technovation*, 27(12), 744-765.
- Huang, C.-Y., Tzeng, G. H., & Ho, W. R. (2010). System on Chip Design Service e-Business Value Maximization Through a Novel MCDM Framework. *Expert Systems with Applications*, 38(7), 7947-7962.
- Ilevbare, I. M., Probert, D., & Phaal, R. (2013). A review of TRIZ, and its benefits and challenges in practice. *Technovation*, 33(2), 30-37.
- Im, S., & Workman Jr, J. P. (2004). Market orientation, creativity, and new product performance in high-technology firms. *Journal of marketing*, 68(2), 114-132.
- Juan, Y.-K., Perng, Y.-H., Castro-Lacouture, D., & Lu, K.-S. (2009). Housing refurbishment contractors selection based on a hybrid fuzzy-QFD approach. *Automation in Construction*, 18(2), 139-144.
- Julong, D. (1989). Introduction to grey system theory. *The Journal of grey system*, 1(1), 1-24.
- Kangas, M. (2010). Creative and playful learning: Learning through game co-creation and games in a playful learning environment. *Thinking Skills and Creativity*, 5(1), 1-15.
- Karsak, E. E., Sozer, S., & Alptekin, S. E. (2003). Product planning in quality function deployment using a combined analytic network process and goal programming approach. *Computers & industrial engineering*, 44(1), 171-190.
- Kelly, J., Male, S., & Graham, D. (2014). *Value management of construction projects*: John Wiley & Sons.
- Kimori, Y. (2013). Morphological image processing for quantitative shape analysis of biomedical structures: effective contrast enhancement. *Journal of synchrotron radiation*, 20(6), 848-853.
- Klukken, P. G., Parsons, J. R., & Columbus, P. J. (1997). The creative experience in engineering practice: Implications for engineering education. *Journal of Engineering Education*, 86(2), 133-138.
- Kunzendorf, R. G. (1982). Mental images, appreciation of grammatical patterns, and creativity. *Journal of Mental Imagery*.
- Kwatra, S., & Salamatov, Y. (2012). *Trimming, Miniaturization and Ideality Via Convolution Technique of TRIZ: A Guide to Lean and High-level Inventive Design*: Springer Science & Business Media.
- Lee, S., & Sai On Ko, A. (2000). Building balanced scorecard with SWOT analysis, and implementing "Sun Tzu's The Art of Business Management Strategies" on QFD methodology. *Managerial Auditing Journal*, 15(1/2), 68-76.
- Lee, Y. S., Huang, J. C., & Hsu, Y. S. (2008). Using Modified Delphi Method to Explore the Competition Strategy for Software Companies of Taiwan. *Journal of Informatics & Electronics*, 13(1), 39-50.
- Levitt, T. (1986). *Marketing Imagination: New*: Simon and Schuster.

- Liang, C., Chi-Cheng, C., Chang, Y., & Li-Jhong, L. (2012). The exploration of indicators of imagination. *TOJET: The Turkish Online Journal of Educational Technology*, 11(3).
- Liao, S., Wu, M.-J., Huang, C.-Y., Kao, Y.-S., & Lee, T.-H. (2014). Evaluating and Enhancing Three-Dimensional Printing Service Providers for Rapid Prototyping Using the DEMATEL Based Network Process and VIKOR. *Mathematical Problems in Engineering*, 2014.
- Lin, C.-L., Hong, J.-C., Hwang, M.-Y., & Lin, Y.-L. (2006). *A Study of the Applicability of Idea Generation Techniques*. Paper presented at the The XVII ISPIM Conference, Athens, Greece.
- Lin, J.-S., Liang, C.-T., Chang, W.-S., & Liang, C. (2015). Relation between Personality Traits and Imaginative Capability of Engineering Students. *INTERNATIONAL JOURNAL OF ENGINEERING EDUCATION*, 31(1), 23-32.
- Lin, W.-S., Hsu, Y., & Liang, C. (2014). The mediator effects of conceiving imagination on academic performance of design students. *International Journal of Technology and Design Education*, 24(1), 73-89.
- Liu, E., & Noppe-Brandon, S. (2009). *Imagination first: Unlocking the power of possibility*. John Wiley & Sons.
- Lu, M.-T., Lin, S.-W., & Tzeng, G.-H. (2013). Improving RFID adoption in Taiwan's healthcare industry based on a DEMATEL technique with a hybrid MCDM model. *Decision Support Systems*, 56, 259-269.
- Luttrupp, C., & Lagerstedt, J. (2006). EcoDesign and The Ten Golden Rules: generic advice for merging environmental aspects into product development. *Journal of Cleaner Production*, 14(15), 1396-1408.
- March, J. G. (1991). Exploration and exploitation in organizational learning. *Organization science*, 2(1), 71-87.
- Marginson, S., Tytler, R., Freeman, B., & Roberts, K. (2013). *STEM: country comparisons: international comparisons of science, technology, engineering and mathematics (STEM) education. Final report*: Australian Council of Learned Academies.
- McFadden, D. (1986). The choice theory approach to market research. *Marketing science*, 5(4), 275-297.
- McGraw, D. (2004). Expanding the mind. *ASEE Prism*, 13(9), 30.
- Mijares-Colmenares, B. E., Masten, W. G., & Underwood, J. R. (1993). Effects of trait anxiety and the scamper technique on creative thinking of intellectually gifted students. *Psychological reports*, 72(3), 907-912.
- Morosini, P. (2010). *Seven keys to imagination: Creating the future by imagining the unthinkable and delivering it*: Marshall Cavendish International Asia Pte Ltd.
- Mumford, M. D., & Gustafson, S. B. (1988). Creativity syndrome: Integration, application, and innovation. *Psychological bulletin*, 103(1), 27.
- Murry, J. W., & Hammons, J. O. (1995). Delphi: A versatile methodology for conducting qualitative research. *The Review of Higher Education*, 18(4), 423-436.
- Norton, J. L. (1994). Creative Thinking and Locus of Control as Predictors of Reflective Thinking in Preservice Teachers.
- Ogot, M., & Okudan, G. E. (2006). Integrating systematic creativity into first-year engineering design curriculum. *International Journal of Engineering and Education*, 22(1), 109.
- Okudan, G. I. E., Ogot, M., & Shirwaiker, R. (2006). *An investigation on the effectiveness of design ideation using TRIZ*. Paper presented at the ASME 2006 International Design Engineering Technical Conferences and Computers and Information in Engineering Conference.
- Osborn, A. F. (1953). Applied imagination.
- Osteras, T., Murthy, D., & Rausand, M. (2006). Product performance and specification in new product development. *Journal of Engineering Design*, 17(2), 177-192.
- Pahl, G., & Beitz, W. (1988). Engineering design: a systematic approach. *NASA STI/Recon Technical Report A*, 89, 47350.
- Perdue, K. (2003). Imagination. The Chicago school of media theory. Retrieved October, 16, 2011.
- Phillips-Wren, G., Jain, L. C., Nakamatsu, K., & Howlett, R. J. (2010). *Advances in Intelligent Decision Technologies: Proceedings of the Second Kes International Symposium Idt 2010*: Springer.
- Politis, J. D. (2005). QFD, organisational creativity and productivity. *International journal of Quality & Reliability management*, 22(1), 59-71.

- Project Management Institute. (2008). *Project Management Body of Knowledge (PMBOK® GUIDE)*. New Squares, P.A.: Project Management Institute.
- Rangaswamy, A., & Lilien, G. L. (1997). Software tools for new product development. *Journal of Marketing Research*, 34(1), 177-184.
- Reichling, M. J. (1990). Images of imagination. *Journal of Research in Music Education*, 38(4), 282-293.
- Reiner, M., & Gilbert, J. (2000). Epistemological resources for thought experimentation in science learning. *International Journal of Science Education*, 22(5), 489-506.
- Ribot, T. (1906). *Essay on the creative imagination*: Open Court.
- Ruchti, B., & Livotov, P. (2001). TRIZ-based innovation principles and a process for problem solving in business and management. *The TRIZ Journal*, 1, 677-687.
- Rutitsky, D. (2010). Using TRIZ as an entrepreneurship tool. *Journal of management*, 17(1), 39-44.
- Saaty, T. L. (1980). *The analytic hierarchy process: planning, priority setting, resource allocation*: McGraw-Hill International Book Co.
- Sapuan, S., Maleque, M., Hameedullah, M., Suddin, M., & Ismail, N. (2005). A note on the conceptual design of polymeric composite automotive bumper system. *Journal of materials processing technology*, 159(2), 145-151.
- Savransky, S. D. (2000). *Engineering of creativity: Introduction to TRIZ methodology of inventive problem solving*: CRC Press.
- Scheffler, I. (2010). In *Praise of the Cognitive Emotions (Routledge Revivals): And Other Essays in the Philosophy of Education*: Routledge.
- Schoemaker, P. J. (1995). Scenario planning: a tool for strategic thinking. *Sloan management review*, 36(2), 25.
- Schweizer, T. P. (2002). Integrating TRIZ into the Curriculum: An Educational Imperative. *TRIZ Journal*.
- Serrat, O. (2009). The SCAMPER technique.
- Silvia, P. J., Winterstein, B. P., Willse, J. T., Barona, C. M., Cram, J. T., Hess, K. I., . . . Richard, C. A. (2008). Assessing creativity with divergent thinking tasks: Exploring the reliability and validity of new subjective scoring methods. *Psychology of Aesthetics, Creativity, and the Arts*, 2(2), 68.
- Souchkov, V. (2007). Breakthrough thinking with TRIZ for business and management: An overview. *ICG Training & Consulting*, 3-12.
- Stevens, G., Burley, J., & Divine, R. (1999). Creativity business discipline= higher profits faster from new product development. *Journal of Product Innovation Management*, 16(5), 455-468.
- Sung, W. C. (2001). Application of Delphi method, a qualitative and quantitative analysis, to the healthcare management. *Journal of Healthcare Management*, 2(2), 11-19.
- Takahashi, M. (1993). *Dictionary of creativity*: Tokyo: Mo To Publishing.
- Tamer Cavusgil, S., Calantone, R. J., & Zhao, Y. (2003). Tacit knowledge transfer and firm innovation capability. *Journal of business & industrial marketing*, 18(1), 6-21.
- Tamura, M., Nagata, H., & Akazawa, K. (2002). Extraction and systems analysis of factors that prevent safety and security by structural models *Proceedings of the 41st SICE Annual Conference, Volume 3*. (pp. 1752-1759). Osaka, Japan. (Reprinted from: IN FILE).
- Tan, R., Ma, L., Yang, B., & Sun, J. (2008). Systematic method to generate new ideas in fuzzy front end using TRIZ. *Chinese Journal of Mechanical Engineering-English Edition*, 21(2), 114.
- Taylor, M. (2013). *The Oxford handbook of the development of imagination*: Oxford University Press.
- Thomas, N. J. (1999). Are theories of imagery theories of imagination?: An active perception approach to conscious mental content. *Cognitive science*, 23(2), 207-245.
- Thompson, G., & Lordan, M. (1999). A review of creativity principles applied to engineering design. *Proceedings of the Institution of Mechanical Engineers, Part E: Journal of Process Mechanical Engineering*, 213(1), 17-31.
- Townsend, D. (2003). Cohen on Kant's aesthetic judgements. *The British Journal of Aesthetics*, 43(1), 75-79.
- Trotman, D. (2006). Interpreting imaginative lifeworlds: Phenomenological approaches in imagination and the evaluation of educational practice. *Qualitative Research*, 6(2), 245-265.

- Tzeng, G.-H., & Huang, C.-Y. (2012). Combined DEMATEL technique with hybrid MCDM methods for creating the aspired intelligent global manufacturing & logistics systems. *Annals of Operations Research*, 197(1), 159-190.
- Tzeng, G.-H., & Tasur, S. (1994). The multiple criteria evaluation of grey relation model. *The Journal of grey system*, 6(2), 87-108.
- Udwadia, F. E. (1990). Creativity and innovation in organizations: Two models and managerial implications. *Technological Forecasting and Social Change*, 38(1), 65-80.
- Ulrich, K. T. (2003). *Product design and development*: Tata McGraw-Hill Education.
- Valett, R. E. (1983). *Strategies for Developing Creative Imagination & Thinking Skills*.
- Van Boeijen, A., Daalhuizen, J., Van Der Schoor, R., & Zijlstra, J. (2014). *Delft Design Guide: Design Strategies and Methods*: Bis B.V., Uitgeverij (BIS Publishers).
- Vygotsky, L. S. (1980). *Mind in society: The development of higher psychological processes*: Harvard university press.
- Vygotsky, L. S. (2004). Imagination and creativity in childhood. *Journal of Russian & East European Psychology*, 42(1), 7-97.
- Vygotsky, L. S., & Luria, A. (1994). Tool and symbol in child development. *The vygotsky reader*, 99-174.
- Wallace, L., Keil, M., & Rai, A. (2004). Understanding software project risk: a cluster analysis. *Information & Management*, 42(1), 115-125.
- Wyssocki, R. K. (2013). *Effective Project Management: Traditional, Agile, Extreme*: Wiley.
- Yang, Y. Q., Wang, S. Q., Dulaimi, M., & Low, S. P. (2003). A fuzzy quality function deployment system for buildable design decision-makings. *Automation in construction*, 12(4), 381-393.
- Zhang, Q., & Doll, W. J. (2001). The fuzzy front end and success of new product development: a causal model. *European Journal of Innovation Management*, 4(2), 95-112.
- Zittoun, T., & Gillespie, A. (2015). *Imagination in human and cultural development*: Routledge.
- Zivkovic, Z., Nikolic, S. T., Doroslovacki, R., Lalic, B., Stankovic, J., & Zivkovic, T. (2015). Fostering creativity by a specially designed Doris tool. *Thinking Skills and Creativity*, 17, 132-148.
- Zlotin, B., Zusman, A., Kaplan, L., Visnepolschi, S., Proseanic, V., & Malkin, S. (1999). TRIZ beyond technology: The theory and practice of applying TRIZ to nontechnical areas. *Detroit: Ideation*. Retrieved June, 2, 2005.

APPENDICES

Appendix A

DEMATEL

The following are explanations of the DEMATEL calculation steps.

Step 1: Build an initial direct-relation matrix

Experts are asked to indicate the direct influence degree between factor i and factor j , as indicated by a_{ij} , using a pair-wise comparison scale designated with five levels. The initial direct-relation matrix A is obtained by deriving the influence relationships between criteria through Equation (A1).

$$A = \begin{bmatrix} a_{11} & a_{12} & \dots & a_{1n} \\ a_{21} & a_{22} & \dots & a_{2n} \\ \vdots & \vdots & \vdots & \vdots \\ a_{n1} & a_{n2} & \dots & a_{nm} \end{bmatrix} \quad (A1)$$

a_{ij} is denoted as the degree to which the i^{th} objective affects the j^{th} objective.

Step 2: Normalize the direct-relation matrix

The normalized direct-relation matrix N is obtained through Equations (A2) and (A3).

$$N = yA \tag{A2}$$

$$y = \min \left\{ 1 / \max_i \sum_{j=1}^n a_{ij}, 1 / \max_j \sum_{i=1}^n a_{ij} \right\}, i, j \in \{1, 2, \dots, n\}. \tag{A3}$$

Step 3: Build the total relation matrix T

The total-relation matrix T is acquired by Equation (A4):

$$T = N + N^2 + \dots + N^\varepsilon = N(I - N)^{-1} \tag{A4}$$

where $\varepsilon \rightarrow \infty$, I is the identity matrix and $N = [x_{ij}]_{n \times n}$.

Step 4: Compute the influence strength of the factors

Aggregate the values of the rows and columns in matrix to obtain T a value r_i and c_i through the Equations (A5) and (A6) respectively. The r_i represents the level of direct or indirect impact on other factors, and c_i represents the level to which it is affected by other factors:

$$r_i = \left[\sum_{j=1}^n t_{ij} \right]_{n \times 1} = [t_i]_{n \times 1} \tag{A5}$$

$$c_i = \left[\sum_{j=1}^n t_{ij} \right]_{1 \times n} = [t_i]_{n \times 1} \tag{A6}$$

Step 5: Produce a causal diagram

A causal diagram can be acquired by mapping a data set $(r_i + c_i, r_i - c_i)$. The value of $r_i + c_i$ indicates the strength of influence. The higher the value of $r_i + c_i$ a factor has, the more related it is to the other factors. Similarly, the value of $r_i - c_i$ indicates the causal relationship between factors. If $r_i - c_i$ is positive, then the factor is a "cause factor," dispatching influence to the others. If $r_i - c_i$ is negative, the factor is an "effect factor," receiving influence from others. The higher the value of $r_i - c_i$ a factor has, the more influence it has on the other factors, and hence this factor is presumed to have a higher priority than the others. In other words, the lower the value of $r_i - c_i$ a factor has, the greater its received influence from the other factors, and consequently, the lower the priority it is assumed to have.

Appendix B

DNP

The steps of the DNP method can be summarized as follows:

Step 1: Calculate the direct-influence matrix by scores. Based on experts' opinions, evaluations are made of the relationships among elements (or variables/ attributes) of mutual influence using a scale ranging from 0 to 4, with scores representing "no influence" (0), "low influence" (1), "medium influence" (2), "high influence" (3), and "very high influence" (4). They are asked to indicate the direct effect they believe a factor will have on factor, as indicated by d_{ij} . The matrix D of direct relations can be obtained.

Step 2: Normalize the direct-influence matrix based on the direct-influence matrix D , the normalized direct relation matrix N is acquired by using Equation (1) as

$$N = vD; v = \min\{1 / \max_i \sum_{j=1}^n d_{ij}, 1 / \max_j \sum_{i=1}^n d_{ij}\}, i, j \in \{1, 2, \dots, n\} \tag{1}$$

Step 3: Attaining the total-influence matrix T . Once the normalized direct-influence matrix N is obtained, the total-influence matrix T of NRM can be obtained.

$$T = N + N^2 + \dots + N^k = N(I - N)^{-1} \tag{2}$$

where $k \rightarrow \infty$ and T is a total influence-related matrix; N is a direct influence matrix and $N = [x_{ij}]_{n \times n}$; $\lim_{k \rightarrow \infty} (N^2 + \dots + N^k)$ stands for an indirect influence matrix and $0 \leq \sum_{j=1}^n x_{ij} < 1$ or $0 \leq \sum_{i=1}^n x_{ij} < 1$, and only one $\sum_{j=1}^n x_{ij}$ or $\sum_{i=1}^n x_{ij}$ equal to 1 for $\forall i, j$. So $\lim_{k \rightarrow \infty} N^k = [0]_{n \times n}$. The (i, j) element of matrix T denotes the direct and indirect influences of factor i on factor j .

Step 4: Analyze the result. In this stage, the row and column sums are separately denoted as r and c within the total-relation matrix T through Equations (3), (4), and (5).

$$T = [t_{ij}], \quad i, j \in \{1, 2, \dots, n\} \tag{3}$$

$$r = [r_i]_{n \times 1} = \left[\sum_{j=1}^n t_{ij} \right]_{n \times 1} \tag{4}$$

$$c = [c_j]_{1 \times n} = \left[\sum_{i=1}^n t_{ij} \right]_{1 \times n} \tag{5}$$

where the r and c vectors denote the sums of the rows and columns, respectively.

Suppose r_i denotes the row sum of the i^{th} row of matrix T . Then, r_i is the sum of the influences dispatching from factor i to the other factors, both directly and indirectly. Suppose that c_j denotes the column sum of the j^{th} column of matrix. Then, c_j is the sum of the influences that factor i is receiving from the other factors. Furthermore, when $i = j$ (i.e., the sum of the row sum and the column sum) $(r_i + c_j)$ represents the index representing the strength of the influence, both dispatching and receiving), $(r_i + c_j)$ is the degree of the central role that factor i plays in the problem. If $(r_i - c_j)$ is positive, then factor i primarily is dispatching influence upon the strength of other factors; and if $(r_i - c_j)$ is negative, then factor i primarily is receiving influence from other factors (C.-Y. Huang, J. Z. Shyu, & G.-H. Tzeng, 2007; Tamura, Nagata, & Akazawa, 2002). Therefore, a causal graph can be achieved by mapping the dataset of $(r_i + s_i, r_i - s_i)$ providing a valuable approach for decision making (see Phillips-Wren, Jain, Nakamatsu, & Howlett, 2010).

Now we call the total-influence matrix $T_C = [t_{ij}]_{n \times n}$ obtained by criteria and $T_D = [t_{ij}^D]_{n \times n}$ obtained by dimensions (clusters) from T_C . Then we normalize the ANP weights of dimensions (clusters) by using influence matrix T_D .

$$\begin{aligned}
 & \left[\begin{array}{cccc} t_{11}^{D_1} & \dots & t_{1j}^{D_1} & \dots & t_{1m}^{D_1} \\ \vdots & \vdots & \vdots & \vdots & \vdots \\ t_{i1}^{D_i} & \dots & t_{ij}^{D_i} & \dots & t_{im}^{D_i} \\ \vdots & \vdots & \vdots & \vdots & \vdots \\ t_{m1}^{D_m} & \dots & t_{mj}^{D_m} & \dots & t_{mm}^{D_m} \end{array} \right] \begin{aligned} & \longrightarrow d_1 = \sum_{j=1}^m t_{1j}^{D_1} \\ & \longrightarrow d_i = \sum_{j=1}^m t_{ij}^{D_i}, d_i = \sum_{j=1}^m t_{ij}^{D_i}, i = 1, \dots, m \\ & \longrightarrow d_m = \sum_{j=1}^m t_{mj}^{D_m} \end{aligned} \tag{6}
 \end{aligned}$$

Step 5: The original supermatrix of eigenvectors is obtained from the total-influence matrix $T = [t_{ij}]$. For example, D values of the clusters in matrix T_D as Equation (8). Where if $t_{ij} < D$, then $t_{ij}^D = 0$ else, $t_{ij}^D = t_{ij}$, and t_{ij} is in the total-influence matrix T . The total-influence matrix T_D needs to be normalized by dividing by the following formula. There, we could normalize the total-influence matrix and represent it as T_D .

$$T_D = \begin{bmatrix} t_{11}^{D_{11}} / d_1 & \dots & t_{1j}^{D_{1j}} / d_1 & \dots & t_{1m}^{D_{1m}} / d_1 \\ \vdots & \vdots & \vdots & \vdots & \vdots \\ t_{i1}^{D_{i1}} / d_i & \dots & t_{ij}^{D_{ij}} / d_i & \dots & t_{im}^{D_{im}} / d_i \\ \vdots & \vdots & \vdots & \vdots & \vdots \\ t_{m1}^{D_{m1}} / d_m & \dots & t_{mj}^{D_{mj}} / d_m & \dots & t_{mm}^{D_{mm}} / d_m \end{bmatrix} = \begin{bmatrix} \alpha_{11}^{D_{11}} & \dots & \alpha_{1j}^{D_{1j}} & \dots & \alpha_{1m}^{D_{1m}} \\ \vdots & \vdots & \vdots & \vdots & \vdots \\ \alpha_{i1}^{D_{i1}} & \dots & \alpha_{ij}^{D_{ij}} & \dots & \alpha_{im}^{D_{im}} \\ \vdots & \vdots & \vdots & \vdots & \vdots \\ \alpha_{m1}^{D_{m1}} & \dots & \alpha_{mj}^{D_{mj}} & \dots & \alpha_{mm}^{D_{mm}} \end{bmatrix} \quad (7)$$

where $\alpha_{ij}^{D_{ij}} = t_{ij}^{D_{ij}} / d_i$. This research adopts the normalized total-influence matrix T_D (here after abbreviated to “the normalized matrix”) and the unweighted supermatrix W using Equation (9) shows theses influence level values as the basis of the normalization for determining the weighted supermatrix.

$$W^* = \begin{bmatrix} \alpha_{11}^{D_{11}} \times W_{11} & \alpha_{21}^{D_{21}} \times W_{12} & \dots & \dots & \alpha_{m1}^{D_{m1}} \times W_{1m} \\ \alpha_{12}^{D_{12}} \times W_{21} & \alpha_{22}^{D_{22}} \times W_{22} & \dots & \dots & \vdots \\ \vdots & \dots & \alpha_{ji}^{D_{ji}} \times W_{ij} & \dots & \alpha_{mi}^{D_{mi}} \times W_{im} \\ \vdots & \vdots & \vdots & \vdots & \vdots \\ \alpha_{1m}^{D_{1m}} \times W_{m1} & \alpha_{2m}^{D_{2m}} \times W_{m2} & \dots & \dots & \alpha_{mm}^{D_{mm}} \times W_{mm} \end{bmatrix} \quad (8)$$

Step 6: Limit the weighted supermatrix by raising it to a sufficiently large power k , as Equation (9), until the supermatrix has converged and become a long-term stable supermatrix to get the global priority vectors or called ANP weights.

$$\lim_{k \rightarrow \infty} (W^*)^k \quad (9)$$

According to the definition by Lu, Lin, and Tzeng (2013), the significant confidence level can be calculated by

$$\frac{1}{n^2} \sum_{i=1}^n \sum_{j=1}^n \frac{|t_{ij}^p - t_{ij}^{p-1}|}{t_{ij}^p} \times 100\% \quad (10)$$

where n denotes the number of criteria. p denotes to the number of experts. t_{ij}^p is the average influence of criterion i on criterion j .

Appendix C

GRA

Since Deng proposed grey theory in 1982 (Julong, 1989), related models have been developed and applied to MCDM problems. Similar to the fuzzy set theory, the grey theory is a feasible mathematical means used to deal with systems analysis characterized by poor information. Fields covered by the grey theory include systems analysis, data processing, modeling, prediction, decision-making and control. In this section, some relevant

definitions and the calculation process for the grey relation model will be reviewed. This research modified the original definitions and produced the new definitions as indicated below.

The GRA is used to determine the relationship between two sequences of stochastic data in a grey system. The procedure bears some similarity to pattern recognition technology. One sequence of data is called the "reference pattern" or "reference sequence," and the correlation of the other sequence to the reference sequence is identified (Deng, 1986; Tzeng & Tasur, 1994).

Definition 1: The relationship scale may also be designated into eleven levels, where the scores of 0, 1, 2, ..., 10 represent 'no relationship' to 'very high relationship', respectively, between the specified criterion and the alternative, respectively.

Definition 2: The initial relationship matrix G is a $m \times n$ matrix, where there are m alternatives and n criteria, obtained by surveying the relationships where g_{ki} is denoted as the relationship between the k^{th} criterion and the i^{th} alternative.

$$G = \begin{bmatrix} g_{11} & g_{12} & \cdots & g_{1n} \\ g_{21} & g_{22} & \cdots & g_{2n} \\ \vdots & \vdots & g_{ki} & \vdots \\ g_{m1} & g_{m2} & \cdots & g_{mn} \end{bmatrix} \tag{C1}$$

$$G_i = [g_{ki}], k \in \{1, 2, \dots, m\}$$

Definition 3: The normalized relationship matrix X can be obtained through the Equations (C2) and (C3).

$$p_i = 1 / \max_{1 \leq k \leq m} g_{ki} \tag{C2}$$

$$X = \begin{bmatrix} x_{11} & x_{12} & \cdots & x_{1n} \\ x_{21} & x_{22} & \cdots & x_{2n} \\ \vdots & \vdots & x_{ki} & \vdots \\ x_{m1} & x_{m2} & \cdots & x_{mn} \end{bmatrix} \tag{C3}$$

$$X_i = [x_{ki}], k \in \{1, 2, \dots, m\}$$

$$X_i = p_i G_i$$

Definition 4: Let X_0 be the reference pattern with n entries (i.e. dependent variable): $X_0 = (x_0(1), x_0(2), \dots, x_0(n))$ and X_i , the matrix containing the normalized mapping information of each alternative to the criteria, be one of the m patterns with n entries to be compared with the X_0 where X_i is written as: $X_i = (x_i(1), x_i(2), \dots, x_i(n)), 1 \leq i \leq m$. The sequence X_i generally expresses the influencing factor of X_0 .

Definition 5: Let X be a normalized factor set of grey relation, $X_0 \in X$ the referential sequence, and $X_i \in X$ the comparative sequence; with $X_0(k)$ and $X_i(k)$ representing respectively the numerals at point k for X_0 and X_i . If $\gamma(X_0(k), x_i(k))$ and $\gamma(X_0, x_i)$ are real numbers, and satisfy the following four grey axioms, then call $\gamma(X_0(k), x_i(k))$ the grey relation coefficient and the grade of grey relation $\gamma(x_0, x_i)$ is the average value of $\gamma(x_0(k), x_i(k))$.

1. Norm Interval
 $0 < \gamma(x_0(k), x_i(k)) \leq 1, \forall k; \gamma(X_0, X_i) = 1$ iff $X_0 = X_i$;
 $\gamma(X_0, X_i) = 0$ iff $X_0, X_i \in \phi$;

where ϕ is an empty set.

2. Duality Symmetric

$$\mathbf{Y}, \mathbf{Z} \in \mathbf{X} \Rightarrow \gamma(\mathbf{Y}, \mathbf{Z}) = \gamma(\mathbf{Z}, \mathbf{Y}) \text{ iff } \mathbf{X} = \{\mathbf{Y}, \mathbf{Z}\}.$$

3. Wholeness

$$\gamma(\mathbf{X}_i, \mathbf{X}_j) \stackrel{\text{often}}{\neq} \gamma(\mathbf{X}_j, \mathbf{X}_i) \text{ iff } \mathbf{X} = \{\mathbf{X}_i | i = 0, 1, \dots, n\}, \quad n > 2.$$

4. Approachability

$\gamma(x_0(k), x_i(k))$ decreases when $|(x_0(k) - x_i(k))|$ is increasing.

Deng also proposed a mathematical equation for the grey relation coefficient as follows:

$$\gamma(x_0(k), x_i(k)) = \frac{\min_{\forall j, j \in i} \min_{\forall k} |(x_0(k) - x_j(k))| + \zeta \max_{\forall j, j \in i} \max_{\forall k} |(x_0(k) - x_j(k))|}{|(x_0(k) - x_i(k))| + \zeta \max_{\forall j, j \in i} \max_{\forall k} |(x_0(k) - x_j(k))|} \quad (C4)$$

where ζ is the distinguished coefficient ($\zeta \in [0, 1]$). Generally, we pick $\zeta = 0.5$.

Definition 6: If $\gamma(x_0, x_i)$ satisfies the four grey relation axioms, then γ is called the Grey Relational Map.

Definition 7: If Γ is the entirety of the Grey Relational Map, $\gamma \in \Gamma$ satisfies the four axioms of grey relation, and \mathbf{X} is the factor set of grey relation, then (\mathbf{X}, Γ) will be called as the grey relational space, while γ is the specific map for Γ .

Definition 8: Let (\mathbf{X}, Γ) be the grey relational space, and if $\gamma(\mathbf{X}_0, \mathbf{X}_j), \gamma(\mathbf{X}_0, \mathbf{X}_p), \dots, \gamma(\mathbf{X}_0, \mathbf{X}_q)$ satisfy $\gamma(\mathbf{X}_0, \mathbf{X}_j) > \gamma(\mathbf{X}_0, \mathbf{X}_p) > \dots > \gamma(\mathbf{X}_0, \mathbf{X}_q)$ then we have the grey relational order as $\mathbf{X}_j > \mathbf{X}_p > \dots > \mathbf{X}_q$.

When the grey relational coefficient is conducted, we can then derive the grade of grey relation $\gamma(x_0, x_i)$ between the reference and alternative imagination stimulation courses.

$$\gamma(\mathbf{x}_0, \mathbf{x}_i) = \sum_{k=1}^n \omega_k \times \gamma(x_0(k), x_i(k)). \quad (C5)$$

where k is the number of criteria, ω_k expresses the weight of the k^{th} criteria, and $\gamma(x_0, x_i)$ represents the grade of grey relation in x_i (the k^{th} imagination stimulation course) correspondence to x_0 . In this study, we rank the imagination stimulation courses based on the grey grades.

<http://www.ejmste.com>



For print copies of this issue or articles please send an e-mail to:

print@modestum.co.uk



Application of Mediating Effect Test in Social Science Research: an Empirical Analysis of Geographic and Institutional Factors

Qi Yue

South China Normal University, CHINA

Xing Hua

Guangdong Youth Vocational College, CHINA

Luan Jiang

South China Normal University, CHINA

Received 17 March 2017 • Revised 26 July 2017 • Accepted 3 September 2017

ABSTRACT

Test for mediating effect is an important method in social science research. In this paper, we applied mediating effect test in corporate acquisition research. Acquisition is one of the most important ways to expand a company, especially in emerging markets. From the perspective of institutional view, we made an empirical research on the relationship between geographic and institutional factors and the acquisition performance based on a sample of acquisitions in China. We found that acquisition legitimacy based on different region, including external and internal legitimacy, has positive effect on acquisition performance. We conclude that cross-region acquisition has negative influence on external legitimacy of acquisition, while having no significant influence on internal legitimacy of acquisition.

Keywords: corporate acquisition (CA), acquisition performance (AP), acquisition legitimacy (AL), institutional view (IV), geographic factor (GF)

INTRODUCTION

Mediating effect is a common way of interaction among variables in social science research. Therefore, effective testing of mediating effects is crucial for revealing relationships among variables. In this paper, we focus on the mediating effect of geographical and institutional factors in acquisitions and make an empirical analysis based on Chinese acquisitions. With reform and opening-up, and the development of the market economy, Chinese local enterprises have achieved rapid growth, and the market scale has achieved rapid expansion (Cui & Jiang, 2012). Many small companies became no longer satisfied with the local market within its own region, and began to operate in other cities or provinces (Yue, 2017). Cross-region acquisition has become one of the most important ways to make cross-region development. Cross-region acquisition can bring economy of scale and economy of scope for the enterprises, because enterprises can make full use of the resources of different regions to achieve synergies and get new internal advantage (Chakrabarti & Mitchell, 2016). At the same time it can be provide new markets and growth opportunities for the enterprise. The business unit in different areas can share the company's core competence in cross-region business. Cross-region acquisition can also provide more opportunities for learning (Trichterborn et al., 2016). However, the fragmentation of power in different areas in China may bring cross-region acquisitions difficulties. For example, when Baogang Group wanted to acquire the Jilin Steel Company, it was resisted by the

© **Authors.** Terms and conditions of Creative Commons Attribution 4.0 International (CC BY 4.0) apply.

Correspondence: Xing Hua, Lecturer, *Department of Finance and Economics, Guangdong Youth Vocational College, China. Address to No.19, Huajing Rd., Tianhe Dist., Guangzhou City 510630, China. Tel: +86-13826007823.*

✉ 66021639@qq.com

State of the literature

- Mediating effect is a common way of interaction among variables in social science research. Therefore, effective testing of mediating effects is crucial for revealing relationships among variables.
- Cross-region acquisition can bring economy of scale and economy of scope for the enterprises, because enterprises can make full use of the resources of different regions to achieve synergies and get new internal advantage.
- Due to the dispersion and complexity of Chinese markets, the Chinese enterprises will encounter great difficulties and obstacles in coordinating different regions and finally obtaining combined benefits.

Contribution of this paper to the literature

- External legitimacy plays a significant mediating role between regional variables and performance variables. Low external legitimacy of cross-regional acquisitions is an important reason why cross-regional acquisitions have negative impacts on acquisition performance when compared to acquisitions in the same region.
- The regional factors of the acquiring and acquired firms significantly affect the acquisition performance of the acquiring firm.
- Cross-region acquisitions will be subject to multiple institutional pressures from local stakeholder groups, thus resulting in external legitimacy problems.

local government in Shandong, and the acquisition finally failed. Even if cross-region acquisitions can occur smoothly, due to the dispersion and complexity of Chinese markets, the Chinese enterprises will encounter great difficulties and obstacles in coordinating different regions and finally obtaining combined benefits. In reality, we can see a lot of failures in cross-regional acquisitions. For example, the Tonggang incident in 2009 was due to the boycott of the employees and the acquisition finally failed.

Can cross-region acquisitions bring better performance compared to the same-region acquisitions? And what difficulties will these enterprises encounter in the process of cross-regional acquisitions? This is a worthy subject. Unfortunately, from the existing literature, we can find little research on the impacts of regional factors on acquisition performance, especially lacking empirical analysis. Considering the institutional factors, this paper introduces the concept of legitimacy to explore the relationship between regional factors, legitimacy and acquisition performance in China from the perspective of institutional-based view, so to provide a theoretical reference for enterprises' decision making in acquisitions.

LITERATURES REVIEWING

As the largest emerging market country in the world, China is still in the period of economic transition with various imperfect institutions, and the impact of institutional factors will be greater (Hoskisson et al., 2000). Acquisitions will affect the internal and external stakeholder, and the attitude of stakeholders reflects the level of legitimacy of acquisitions (Chan & Makino, 2007). The strategic behavior of an enterprise will affect its level of legitimacy, and different levels of legitimacy will influence the enterprise' performance. According to the theory of institutional-based theory, the legitimacy of enterprise behaviors can be divided into external legitimacy and internal legitimacy (Dacin, Oliver & Roy, 2007). The external legitimacy of acquisitions refers to the degree of recognition and support from the government, the upstream and downstream enterprises, the public, etc., in the regions where the acquiring and acquired enterprises are located especially where the acquired enterprises are located. The internal legitimacy of acquisitions emphasizes the recognition and support received by the shareholders, management and general employees of the acquired enterprises.

Region, External Legitimacy and Acquisitions Performance

The level of external legitimacy obtained from acquisitions has an important impact on enterprises. Firstly, in China, government authority is of great significance for enterprises to conduct their business and maintain their market positions (He & Li, 2000). So in many cases, the support from the government plays a decisive role in the

success of acquisitions and post-acquisition performance. Besides, the local protectionism in each administrative area is serious, and the government officials at various levels will make a lot of demands and restrictions on enterprises, especially foreign enterprises for consideration of their achievements. For firms who want to enter into a new area or market but do not have sufficient external legitimacy, the institutional environment seems expensive and difficult to manage, and it will cost a lot (Bertrand, Betschinger & Settles, 2016). As for enterprises that can meet the expectations of the government, they will acquire policy and resource support. In addition, the relationship between enterprises and their upstream and downstream manufacturers is in a critical position in the enterprise value chain, which is of strategic significance for the development of enterprises (Kim & Finkelstein, 2009). Obtaining more recognition and support from upstream and downstream enterprises is helpful to reduce the relationship costs and search costs after acquisitions, and also conducive to learning among partners. In addition, research shows that the corporate social responsibility and response of the public are closely related to the enterprises' strategy, good social responsibility image is essential to business development (Suchman, 1995). Authoritative social public organizations, such as public interest groups, local associations, professional or expert associations, can closely monitor whether companies comply with social norms and social expectations (DiMaggio & Powell, 1983). To some extent, these social organizations have the power to make rules, standards and principles, whether they can acquire the support from these public organizations will have a significant impact on the success and performance of acquisition. That is to say, the external legitimacy is theoretically helpful to achieve the expected goal of acquisition.

However, compared with same-regional acquisitions, cross-regional acquisitions will bring a negative impact on the external legitimacy of enterprises (Shimizu et al., 2004). From the perspective of local government departments, local taxes may be affected by local enterprises acquired by foreign companies, especially when the acquirers cancel the independent legal personalities of the acquired enterprises. From the perspective of personal interests of relevant officials, senior officials who are familiar with situations may leave because of acquisitions, which will lead to a certain degree of inconvenience after acquisitions and may also affect the potential interest channels. Similarly, for the local upstream and downstream enterprises, cross-regional acquisitions may lead to changes in executives of former firms so as to bring problems in the cooperation. At the same time, cultural differences between foreign and local enterprises may also lead to communication problems and weakening of learning effects. And from the local social institutions and the public, they may worry that outsiders lack local affection. This will lead to absence of social responsibility, therefore they may have certain conflict with outsiders or give more responsibilities and expectations to outsiders. So, compared to the same-region acquisitions, cross-regional acquisitions may be resisted by various external stakeholders. Overall, cross-regional acquisitions will lead to the challenges of acquirers' external legitimacy, which will directly affect the acquisition performance. Therefore, this paper proposes the following hypothesis:

- H1:** The external legitimacy of acquisition plays a mediating role between regional factors and acquisition performance.

Region, Internal Legitimacy and Acquisition Performance

Enterprises need to obtain legitimacy not only from the external institutional environment but also internally (Yue, Li & Jiang, 2016). Internal legitimacy is especially important for acquirers, because getting enough identification and support from the acquiring enterprises will directly affect the operation of the acquirers in post-acquisition (Cording, Christmann & King, 2008). If it is not a whole acquisition, obtaining more recognition from the original shareholders and board members of the acquiring enterprise will make decision-making more unified and efficient after the acquisition, and make the subsequent resource support more likely. Long-term and stable resource support can benefit the market expansion after acquisition and provide more powerful guarantee for the acquisition performance (Li & Zhou, 2007). From the perspective of the management, lower internal legitimacy means that the support from the management of the acquiring enterprises is not high, which will lead to conflicts and operational inefficiencies in internal decision-making after acquisitions. Whether the purpose of acquisitions is to enter a new market or develop new business or expand existing business and market status, the recognition and support of the original manager from the acquired enterprises directly affects the progress of the acquisitions

or the operation after acquisitions (Inkpen, Sundaram & Rockwood, 2000). If the managers from the acquired enterprises have a high degree of acceptance for the acquisition, they will use their experience and social relations to maintain and develop business after the acquisition, which will help reduce the coordination costs and promote information exchange between the acquiring and acquired sides. The smooth information transfer mechanism will make the acquirers' strategic intention transfer more efficient, the managers from the acquired enterprises can more easily understand the main purpose and strategy of the acquirers so to form more consistent strategic interests, and also reduce the agency costs and opportunism risks after the acquisition to a certain extent, which is beneficial to the acquirers to achieve their acquisition goals. From the perspective of the staff, if the employee of the acquired firm supports the acquisition, this will affect the reorganization and integration of the acquirers, and even directly affect the success of the acquisitions. The higher acceptance and recognition of the former employees of the acquired enterprise has, the better coordination and cooperation between the two sides of the acquisition will be, and employees from the acquired enterprise will be willing to make efforts to continue learning and communication, and can thus achieve consensus on corporate culture and values more easily and quickly so that the acquired side has an easier understanding of the enterprise's overall strategic targets. Employees from both sides will also face the challenges from the external environment of enterprises on the basis of consensus. Moreover, in the long run, the unified organizational culture formed on the basis of the high degree of consensus after acquisition will remain steady for a longer period of time, which will play a key role in the future development of the acquiring enterprise. Additionally, according to the view of organizational behavior, the higher recognition of corporate behaviors the employees have, the stronger informal communication and knowledge sharing among employees will be. These can promote the effects of organizational learning, therefore help achieve a whole strategic interest for the acquirers.

However, compared to same-regional acquisitions, cross-regional acquisitions will have some challenges for the internal legitimacy of acquirers. First of all, cross-regional acquisitions are more likely to cause job changes and interest loss, because the acquirers may replace some of the original executives since they would want to implement a stronger control to achieve better integration and operation, or they worry that original managers may produce conflicts or potential opportunistic behaviors. Secondly, from the perspective of the acquired enterprise's employees, there will be a conflict between different cultures. Besides, the degree of personnel changes may be higher and cause greater impact (Bruton, Oviatt & White, 1994). To sum up, the internal legitimacy of acquisitions has an impact on the acquisition performance, and cross-regional acquisitions will bring challenges to internal legitimacy of the acquirers. Thus, this paper proposes the following hypothesis:

H2: The internal legitimacy of acquisition plays a mediating role between regional factors and acquisition performance.

RESEARCH DESIGN

Sample

This study uses questionnaire survey to obtain first-hand data for empirical analysis. The samples of the survey are enterprises that have carried out acquisitions, and an acquisition forms a sample. Based on the design of this study, acquisitions refer to the acquisition of assets or equity by the acquiring enterprise, thus becoming the largest shareholder of the acquired company. The respondents are executives or persons directly responsible for acquisitions. A total of 282 questionnaires were issued and 133 were recovered, of which 123 were valid, and the effective rate was 43.62%. Nearly 80% of the 123 respondents are senior and middle managers (mainly including the chairman, general manager or deputy general manager and department head), so the quality of the questionnaire was well guaranteed. The proportion of acquisitions in the sample occurring within the last five years is close to 80%, which can be regarded as a good memory for acquisitions and further enhance the reliability of the questionnaire.

Variables

- (a) Region. The regional factor (REG) was a 0-1 dummy variable in the study. As China's most basic administrative unit is province, this study defines cross-region as cross-province. If the acquiring and acquired sides are located in different provinces, the value is 1, otherwise the value is 0.
- (b) Acquisition legitimacy. This study refers to Chan and Makino (2007) and Dacin et al. (2007) to design the measurement of acquisition legitimacy. External validity (EX_LEG) consists of five items, respectively measuring the extent to which the government, suppliers, customers, important social organizations and the public of the acquired enterprise are in support of the acquisition. Internal legitimacy (IN_LEG) consists of three items, respectively measuring the extent to which the original management, general staff, and shareholders of the acquired enterprise are in support of the acquisition. Both external and internal legitimacy are measured using Likert five points method, with the highest support value of 5 and the minimum value of 1. As there is no empirical research on the measurement of legitimacy in China at present, we tested the reliability and validity of the variable measurement after the questionnaires were collected. The results showed that both the external and internal legitimacy of the Cronbach's Alpha values were greater than 0.9, and the coefficients of internal consistency of each project were greater than 0.8, the values of Cronbach's Alpha if Item Deleted were less than the values of Cronbach's Alpha, so the variables were proved to be of good reliability. The factor analysis showed that the factor loadings of each item were greater than 0.7, and the cumulative variation explained more than 70%, indicating that the variables have good validity.
- (c) Acquisition performance. This study refers to Hunt (1990), Datta (1995), and Capron and Hulland (2009) to measure the acquisition performance (PERF) of the acquirers from the market share, sales revenue, profits, profitability, and cash flow. By setting up related questions in the questionnaire, the respondents determine the extent to which the acquirers achieve their desired goals in all respects compared to the expected target, Likert five points method is used to measure the performance of acquisition.
- (d) Control variables. Combined with previous research on factors affecting acquisitions, this study sets up controlling variables such as shareholding ratio of state-owned shares of the acquirer, acquisition experience, acquisition performance of the acquired enterprise, relative scale in the regression model. Specific measures are as follows: 1) State-owned shares of the acquirers (STAT): proportion of state-owned shares of acquirers. 2) Acquisition experience (EXP): the richness of acquisition experience with acquirers before this acquisition, measured by Likert five points. 3) Shareholding ratio (SHARE): the equity ratio of the acquired enterprise that the acquirers obtain through this acquisition. 4) Performance of the target relative to the industry average (POT): the performance of the acquired firms, measured by Likert five points. 5) Relative size (SIZE): relative to the acquiring enterprise, the size of the acquired enterprise. The relation model of the variables is shown in [Figure 1](#).

ANALYSIS OF THE RESULTS

[Table 1](#) shows the mean, standard deviation and Pearson-correlation coefficient matrix of each variable. It is worth to point out that the average value of regional factors was 0.34, which means that 34% of the samples are cross-regional acquisitions, that is, 42 of the 123 acquisition samples are cross-province. From the correlation coefficient of variables, we can see that the acquisition performance has positive correlation with external legitimacy and internal legitimacy, but has no significant correlation with regional factors. And regional factor has a significant positive correlation with external legitimacy, but has no significant correlation with internal legitimacy. The results of the correlation analysis are a preliminary description of the relationship between variables, and further regression analysis is necessary to more precisely examine the relationships between variables in the hypothesis. This study sets the following models to examine the mediating effect of legitimacy on the structure and acquisition performance, and the regression results of this model are shown in [Table 2](#).

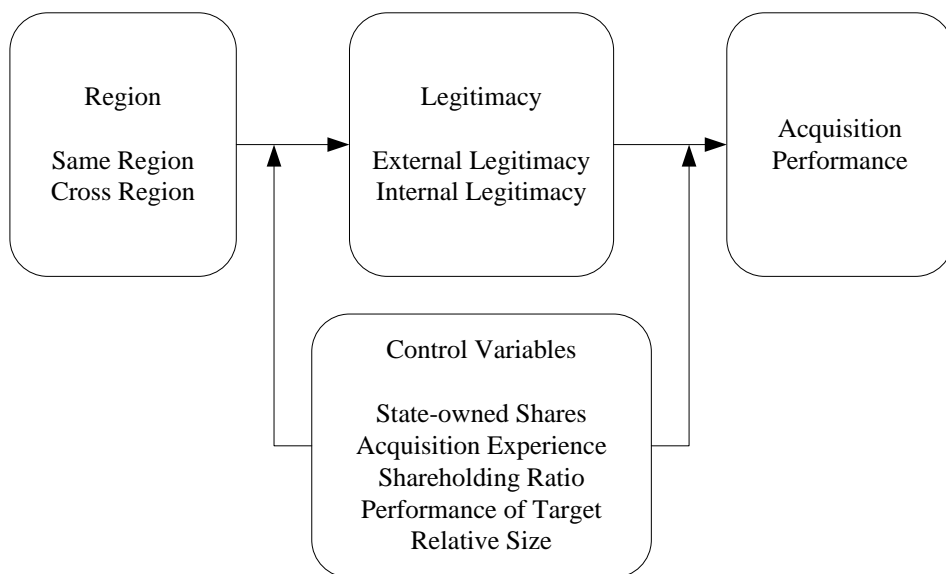

Figure 1. The relation model of the variables

Table 1. The correlation coefficient matrix of all variables in the study

Variable	Mean	St.D.	PERF	EX_LEG	IN_LEG	REG	SHARE	NAT	EXP	POT
PERF	3.78	0.96								
EX_LEG	3.89	0.89	0.24**							
IN_LEG	4.17	0.65	0.42***	0.668***						
REG	0.34	0.48	0.01	-0.243**	-0.01					
SHARE	0.63	0.34	-0.28**	0.05	-0.18**	0.13				
NAT	0.58	0.46	0.04	0.295**	0.19*	-0.52***	-0.26**			
EXP	2.89	1.14	0.54***	0.26**	0.29**	0.25**	-0.23*	0.02		
POT	2.93	1.37	0.51***	0.11	0.33***	0.31***	-0.17*	0.07	0.39***	
SIZE	2.31	1.2	-0.12	0.04	0.11	0.19*	-0.16*	-0.31***	0.01	0.14

*p<0.1, **p<0.01, ***p<0.001

Table 2. The regression results of the models in the study

Variable	Model 1		Model 2		Model 3		Model 4		Model 5	
	PERF	PERF	EX_LEG	EX_LEG	PERF	PERF	IN_LEG	IN_LEG	PERF	PERF
	Coefficient	t-value	Coefficient	t-value	Coefficient	t-value	Coefficient	t-value	Coefficient	t-value
REG	-0.66***	-3.93	-0.54**	-2.75	-0.58**	-3.36	-0.08	-0.54	-0.63***	-3.93
EX_LEG					0.16*	1.97				
IN_LEG									0.34**	3.47
STATE	-0.61***	-3.55	0.51*	2.56	-0.69***	-3.95	0.24	1.56	-0.70***	-4.17
EXP	0.34***	5.63	0.28***	3.98	0.30***	4.67	0.11*	2.04	0.30***	5.15
SHARE	-0.50*	-2.5	0.74**	3.19	-0.61**	-2.99	-0.04	-0.21	-0.49*	-2.55
POT	0.34***	6.49	0.04	0.68	0.33***	6.43	0.12*	2.47	0.30***	5.85
SIZE	-0.20**	-3.54	0.15*	2.34	-0.22***	-3.92	0.07	1.42	-0.22***	-4.13
Adj_R ²	0.5		0.23		0.52		0.14		0.55	
F-value	21.74***		7.09***		19.66***		4.40***		22.12***	

*p<0.1, **p<0.01, ***p<0.001

As seen from **Table 2**, in model 1, the regression coefficient of regional factors was -0.66 ($p < 0.001$), which shows that regional factors can significantly explain variation in the acquisition performance, and the coefficient is negative indicating that cross-regional acquisitions will have a negative impact on acquisition performance. Model 2 and model 3 play a mediating role in testing external legitimacy, model 4 and model 5 play a mediating role in testing internal legitimacy. The results of model 2 show regression coefficient of regional factors and external legitimacy is significantly negative, that is to say regional factors can significantly explain the changes of external legitimacy. Model 3 is the addition of mediation variable (external legitimacy) on the basis of model 1. The results show that the correlation between regional factors and acquisition performance is weakened after controlling the variable of external legitimacy ($\beta = -0.58$, the absolute value is less than -0.66 in model 1). Based on the above results, we can see that the three conditions for verifying the mediating role are satisfied. That is to say, the external legitimacy has a significant mediating effect on the regional factors and the acquisition performance, thus hypothesis H1 is supported. Although the results of model 5 show that the correlation between regional factors and acquisition performance is weakened ($\beta = -0.63$, the absolute value is less than -0.66 in model 1) after controlling the variable of internal legitimacy. However, the results of model 4 show the regression coefficients of regional factors and internal legitimacy do not pass the significance test. Therefore, internal legitimacy has no significant mediating effect on regional factors and acquisition performance, thus hypothesis H2 is not supported.

Additionally, we can see from the regression coefficients of the control variables and the acquisition performance that there is a significant negative correlation between state-owned shares of the acquirer, shareholding ratio and relative scale. So we can reach the following conclusions: the higher the proportion of state-owned shares are, the more unfavorable the acquisition performance is. After the acquisition, the higher shareholding ratio the acquirer has, the more unfavorable the acquisition performance is. Before acquisition, the bigger relative scale the acquired enterprise has, the more unfavorable the acquisition performance is. Besides, the regression coefficient of the acquisition experience and acquired enterprise's performance is significantly positive, which shows that the more acquisition experience the acquirer has, the better relative performance the acquired enterprise has and the more favorable the acquisition performance is.

CONCLUSIONS

With the development of our market economy and the increasing competition from multinational enterprises in China, the local cross-regional acquisitions are increasingly more common, which are considered to be an important way of development for enterprises. Its potential theoretical logic is that it can gain economies of scale, economies of scope, complementary effects and learning effects through the expansion of multi-region and multi-market, so as to achieve greater benefits. However, this study found that compared to the acquisitions in the same region, cross-region acquisitions in China did not show significant positive effects on acquisition performance. Through further examination of the intermediary role of legitimacy, we found that external legitimacy plays a significant mediating role between regional variables and performance variables. So to some extent, the low external legitimacy of cross-regional acquisitions is an important reason why cross-regional acquisitions have negative impacts on acquisition performance compared to acquisitions in the same region.

The results of this study confirm that the regional factor of the acquiring and acquired firms significantly affect the acquisition performance of the acquiring firm. In China, there are considerable differences in the institutional environment and regional culture in different regions, so enterprises need to pay considerable costs to overcome obstacles caused by these differences. For example, in a developed region of market economy, the corresponding market system is more perfect, so the development of enterprises relies more on their own competitiveness and management level, but in the underdeveloped regions where the market system is not perfect, the establishment and consolidation of market position may need to be supported by local government or other social relations, and the acquisition of this relationship may need long-term investment and accumulation, therefore, compared to the local enterprises, the foreign enterprises who enter into the market through acquisitions may have a greater disadvantage, which may lead the acquirers to being able to promote the business and expand the market effectively after acquisition. Additionally, because the management from the acquiring enterprise may be unfamiliar with the local market or business, they can't make effective decisions or supervision, and cross-

regional acquisitions will have a certain impact on the control after acquisitions, leading to increased costs of potential opportunism.

This study supports the view of institutional theory, indicating that cross-region acquisitions will be subject to multiple institutional pressures from local stakeholder groups, thus resulting in external legitimacy problems. That is to say, compared to the acquisitions in the same region, acquiring enterprises in cross-regional acquisitions will face a foreign responsibility, they will be given greater expectations to behave well, and the potential costs and risks will be greater if they behave badly. Correspondingly, taking on the foreign responsibility will lead enterprises to invest more resources. Although the empirical results of this study show that cross-regional acquisitions have statistical negative effects on the external legitimacy and acquisition performance, we need to point out that there exist a certain number of successful cross-regional acquisitions. Therefore, in cross-regional acquisitions, enterprise managers should develop a reasonable strategy to obtain as higher external and internal legitimacy as they can, so to offset the lack of legitimacy caused by cross-regional acquisitions, and finally realize the goal of acquisitions.

ACKNOWLEDGEMENT

This research is supported by National Humanities and Social Science in China under Grant No 17BJR01063, Guangdong Natural Science Foundation under Grant No 2014A030313442, Guangzhou Philosophy and Social Science under Grant No 2017GZYB43, and Key Projects of Philosophy and Social Sciences Research of Ministry of Education in China under Grant No 15JZD020.

REFERENCES

- Bertrand, O., Betschinger, M.-A., & Settles, A. (2016). The relevance of political affinity for the initial acquisition premium in cross-border acquisitions. *Strategic Management Journal*, 37(4), 2071-2091.
- Bruton, G., Oviatt, M., & White, A. (1994). Performance of acquisitions of distressed firms. *Academy of Management Journal*, 37(4), 972-989.
- Capron, L., & Guillen, M. (2009). National corporate governance institutions and post-acquisition target reorganization. *Strategic Management Journal*, 30(8), 803-833.
- Chakrabarti, A., & Mitchell, W. (2016). The role of geographic distance in completing related acquisitions: Evidence from U.S. chemical manufacturers. *Strategic Management Journal*, 37(2), 673-694.
- Chan, C.-M., & Makino, S. (2007). Legitimacy and multi-level institutional environments: implications for foreign subsidiary ownership structure. *Journal of International Business Studies*, 38(2), 621-638.
- Cording, M., Christmann, P., & King, D. (2008). Reducing causal ambiguity in acquisition integration: intermediate goals as mediators of integration decisions and acquisition performance. *Academy of Management Journal*, 51(4), 744-767.
- Cui, L., & Jiang, F. (2012). State ownership effect on firms' FDI ownership decisions under institutional pressure: A study of Chinese outward-investing firms. *Journal of International Business Studies*, 43(1), 264-284.
- Dacin, M., Oliver, C., & Roy, J. (2007). The legitimacy of strategic alliances: an institutional perspective. *Strategic Management Journal*, 28(1), 169-187.
- Datta, D., & Puia, G. (1995). Cross-border acquisitions: an examination of the influence of relatedness and cultural fit on shareholder value creation in U.S. acquiring firms. *Management International Review*, 35(2), 337-359.
- DiMaggio, P., & Powell, W. (1983). The iron cage revisited: Institutional isomorphism and collective rationality in organizational fields. *American Sociological Review*, 48(1), 147-160.
- He, Y., & Li, X.-C. (2000). A preliminary study on the strategy of trans-regional expansion of enterprises. *Management World*, 16(6), 106-114. (in Chinese)
- Hoskisson, R., Eden, L., Lau, C.-M., & Wright, M. (2000). Strategy in emerging economies. *Academy of Management Journal*, 43(2), 249-267.
- Hunt, J. (1990). Changing pattern of acquisition behavior in takeovers and consequences for acquisition processes. *Strategic Management Journal*, 11(1), 69-77.

- Inkpen, A., Sundaram, A., & Rockwood, K. (2000). Cross-border acquisitions of U.S. technology assets. *California Management Review*, 42 (Spring), 50-70.
- Kim, J., & Finkelstein, S. (2009). The effects of strategic and market complementarity on acquisition performance: evidence from the U.S. commercial banking industry. *Strategic Management Journal*, 30(2), 617-646.
- Li, S.-M., & Zhou, X.-C. (2007). An empirical research of corporate characteristics, industry characteristics and acquisition strategy types. *Management World*, 23(3), 130-137. (in Chinese)
- Shimizu, K., Hitt, M., Vaidyanath, D., & Pisano, V. (2004). Theoretical foundations of cross-border mergers and acquisitions: A review of current research and recommendations for the future. *Journal of International Management*, 10(2), 307-353.
- Suchman, M. (1995). Managing legitimacy: Strategic and institutional approaches. *Academy of Management Review*, 20(3), 571-610.
- Trichterborn, A., zu Knyphausen-Aufseß, D., & Schweizer, L. (2016). How to improve acquisition performance the role of a dedicated M&A function, M&A learning process, and M&A capability. *Strategic Management Journal*, 37(2), 763-773.
- Yue, Q. (2017). Contract or Relationship in Cross-region Alliance: Alliance Control, Institutional Distance and Alliance Performance of the Chinese Cross-region Alliances. *Journal of Business Economics*, 27(5), 42-51. (in Chinese)
- Yue, Q., Li, J.-Y., & Jiang, L. (2016). Relational governance, alliance type and alliance performance in Chinese strategic alliances. *Soft Science*, 30(8), 85-88. (in Chinese)

<http://www.ejmste.com>



<http://www.ejmste.com>



<https://twitter.com/ejmste>



<https://www.facebook.com/ejmste>



<http://modestum.co.uk/>



publications@modestum.co.uk



OPEN ACCESS

EURASIA Journal of Mathematics Science and Technology Education
ISSN: 1305-8223 (online) 1305-8215 (print)
2017 13(9):6295-6301
DOI: 10.12973/eurasia.2017.01064a



A Study of the Performance Evaluation on E-Learning in Public Sectors

Hong-Cheng Liu

Department of Public Policy and Management, I-Shou University, Kaohsiung City, TAIWAN, ROC

Received 22 April 2017 • Revised 13 July 2017 • Accepted 24 August 2017

ABSTRACT

In the 21st century, the major competitiveness of a country lies in the talents whose power generated from knowledge would become the most powerful tool, especially the knowledge and competitiveness resulted from e-learning. Aiming at the departments in Kaohsiung City Government, Data Envelopment Analysis (DEA) is applied to the efficiency assessment of e-learning, in which Delphi Method is utilized for selecting inputs, including number of employees, invested costs, management expenses, and output of yearly performance assessment. Sensitivity Analysis is further applied to acquiring the departments with the best efficiency, and individual departments with management efficiency are also analyzed. The research outcomes show that 1.ten departments in Kaohsiung City Government with constant returns to scale achieve the optimization in e-learning efficiency, 2.two departments appear decreasing returns to scale that decreasing the scale might be able to enhance the marginal returns and improve the e-learning efficiency, and 3.eleven departments present increasing returns to scale, showing that the scale could be enlarged to enhance the marginal returns and further promote the efficiency.

Keywords: data envelopment analysis, e-learning, public sectors, city government, employee

RESEARCH BACKGROUND AND PURPOSE

The development of information technology and the popularity of Internet have resulted in the emphasis on e-learning in various countries and fields of education. The services from the government, such as information, knowledge, skills, policies, and regulation propaganda, present brand-new methods through e-learning. In terms of industrial applications, the introduction of e-learning could reduce the training period of employees, break through the restriction on space, and enhance the learning performance. In regard to educational and technological trainings, well-known instructors could be everywhere through e-learning.

National Science Council started promoting Taiwan e-Learning Program in 2002, and Industrial Development Bureau, Ministry of Economic Affairs, also proposed e-Learning Industry Promotion and Development Program and indicated in the investigation that manufacturers in Tree Trillion Industry of semiconductor, flat panel display, and communication intended to introduce e-learning, reflecting the boom of e-learning. Moreover, the investigation of Institute for Information Industry indicated that enterprises in Three Trillion Industry, which had already introduced e-learning, appeared the major effect of Reducing Training Costs and Enlarging Training Areas. As a result, the introduction of e-learning could effectively reduce costs and enhance competitive strengths. With the actively promotion of the government, e-learning is increased the development

© **Authors.** Terms and conditions of Creative Commons Attribution 4.0 International (CC BY 4.0) apply.

Correspondence: Hong-Cheng Liu, *Department of Public Policy and Management, I-Shou University, No.1, Sec. 1, Syuecheng Rd., Dashu District, Kaohsiung City 84001, Taiwan, ROC.*

✉ hcliu@isu.edu.tw

State of the literature

- The services from the government, such as information, knowledge, skills, policies, and regulation propaganda, present brand-new methods through e-learning.
- The introduction of e-learning could effectively reduce costs and enhance competitive strengths. With the actively promotion of the government, e-learning is increased the development space and enhanced the overall development.
- This study therefore analyzes the e-learning efficiency in public sectors, tending to understand the e-learning efficiency and the improvement directions.

Contribution of this paper to the literature

- From the analyses with DEA, the proportion of the departments in Kaohsiung City Government not achieving Scale efficiency is rather high that the inputs for e-learning should be re-considered and adjusted so as to promote the competitiveness.
- It is suggested that the relatively inefficient sectors should pay attention to the number of recruitment, the equipment for e-learning, and the inputs of management expenses in order to reduce the over-waste of resources.

space and enhanced the overall development. E-learning of governmental departments is actively developing under the guidance of Directorate-General Personnel Administration, Executive Yuan, Ministry of Education, and Ministry of Culture. Apparently, e-learning presents specific effects on public sectors and industries under the promotion of the government and the active development of the civil. Nonetheless, the development of e-learning in public sectors is lack of strategic planning and horizontal integration for overall development that the organizations establish e-learning by themselves and merely consider the internal demands. Such development causes repeated development of common curriculum on various websites and abundant hardware equipment which indirectly result in the repeated input and waste of resources. Curriculum with uneven quality not only could not promote the learning performance, but also could cause persecution. This study therefore analyzes the e-learning efficiency in public sectors, tending to understand the e-learning efficiency and the improvement directions. The research outcomes not only could provide direct suggestions for public sectors, but could also be the reference to e-learning for enterprises.

LITERATURE REVIEW

e-Learning

Tsou (2011) considered that the numerous resources of e-learning could be the learning items for individuals and allow people instantaneously receiving the message when necessary and learning from others. Rosenberg (2001) proposed that e-learning was the solutions delivered through Internet technology that three requirements should be presented for enhancing knowledge and promoting performance, namely 1.being networked, as it allowed real-time updating, storing, accessing, transmitting, and sharing instructions or information, 2.applying Internet technology, with which the learning curriculum could be delivered to the end-users of e-learning, and 3.focusing on the broadest view of learning solutions to go beyond the traditional paradigms of training.

In the research report of WR Hambrecht +Co. (2000), e-learning was classified into

1. Computer-based Learning (CBL), in which the learning contents were stored in disks so that people could independently learn with computers, without interacting with others, and the computers did not need to be connected;
2. Web-based Learning (WBL), learning through Internet, including Computer-based Learning;
3. e-Learning, learning through electronic media, including Internet, computers, satellite broadcast, tapes, and interactive disks; and,

4. Distance Learning, in which instructions could be proceeded through e-learning and teaching by correspondence that it covered broader range.

Learning Circuits, a network magazine in the USA, defined e-learning as learners learn by transmitting learning contents through electronic media, such as computers, Internet, recorders, tapes, interactive disks, and satellite broadcast. Banc of America Securities further defined e-learning as the integration of learning and Internet. Cisco defined e-learning as a learning method through Internet, containing the elements of diverse content delivery, managers' experiences, and network communities for enhancing exchange among learners (Huang, 2010). E-learning features to break through the restrictions of space and time in traditional instructions so that learners could learn without being restricted by time and space. E-learning also presents the following characteristics and advantages (Lee, 2009), 1.No problem in learning, as the learning is not restricted by time and space; 2.Searving more people, as it allows infinite people to learn, with highly repeated usability; 3.Highly reusable materials, which could effectively reduce instructional costs; 4.Rich learning resources, as online resources could be utilized as the learning index for enhancing learning effects; 5.Tailored learning contents and process that learners could select curriculum and materials based on personal level and preference, without being instructed with identical teaching plans as in traditional instructions, to achieve the learning effects; 6.Complete record of learning process, which allows learners to understand and inspect the learning process and instructors to master the learning conditions of learners; and, 7.Effective accumulation of knowledge, as for learners, individual knowledge could be effectively and gradually accumulated through complete learning process and systematic learning records, and for enterprises, knowledge could be effectively organized and accumulated and rapidly delivered to employees for practical knowledge management.

Selection of Input and Output Factors

Efficiency is composed of inputs and outputs, meaning the degree of transforming inputs into outputs, i.e. the input-output ratio. Activities of an organization refer to transforming various input resources into outputs, where inputs are the resources contributing to outputs, while outputs are the specific measuring items for achieving the organizational objective. Management efficiency is related to the capability and stability of managers' decision-making that it is the organizational efficiency set by managers' actions and decisions. Management efficiency measured by Data Envelopment Analysis requires the selection of input and output factors so as to effectively evaluate the management efficiency of various Decision-Making Units.

Generally speaking, the selection of input and output factors is considered subjective, which refers to literature review or applies Delphi Method and Adhoc Methods to confirming the input and output factors of an organization. Liu et al. (2010) selected various input and output variables with literature review and further measured the management performance of Credit Department of Fishermen's Associations. In the measurement of efficiency assessment of Credit Department of Farmers' Associations, the measurement of organizational performance of environmental institutes, and the quality of public security in Taiwan, Chang (2009), Huang (2009), and Chang (2010) utilized relevant literatures to select the input and output variables.

In the research on the performance appraisal of social welfare foundations in Taiwan and the relative efficiency assessment of national senior high schools, Chang et al. (2009) and Su et al. (2011) confirmed the input and output factors with expert interviews. Chang et al. (2011) applied Delphi Method to selecting the input and output factors and further measured the efficiency. Nevertheless, the process of Delphi Method is regarded complex and requirrs large amount of time, energy, and costs, the retrieval rate of questionnaires is rather low and likely to distort the experts' opinions, and the questionnaires and the expert opinions are fuzzy that the selection of input and output factors should combine the expert opinions, reduce invested costs, and avoid fuzziness in interviews. In this case, Fuzzy Delphi Method (FDM) is therefore utilized for selecting input and output factors in this study.

RESEARCH DESIGN

When applying Data Envelopment Analysis to process efficiency assessment, each input/output would reduce the discrimination of Data Envelopment Analysis. In this case, 4 inputs and 5 outputs could induce 20 output/input ratios that at least more than two DMUs are required for the discrimination of the model. With DEA to measure e-learning efficiency, appropriate input and output factors should be selected for effectively evaluating the learning performance of DMUs. To combine the selection of input and output factors with expert opinions, reduce invested costs, and avoid fuzziness in the process, Fuzzy Delphi Method is applied to selecting the input and output factors. Total 20 questionnaires are distributed, and 16 copies are retrieved, with the retrieval rate 80%. Fremont et al. (1970) indicated that the public opinions from more than five participants could become the basis for analyses. The interviewed experts in this study cover industries, officials, and academia, who reveal frequent interactions on e-learning that they should present certain representative.

After the computation of Fuzzy Delphi Method, the geometric mean is considered as the common sense for experts evaluating the input and output factors. Besides, the median of the evaluation scores is regarded as the standard to select the input and output factors for measuring the e-learning of Kaohsiung City Government. There are three input/output variables in this study, and, with strict selection, total 23 DMUs are practicable that it corresponds to the rules of experience in Data Envelopment Analysis supported by Golany & Roll (1989).

The data of all variables are acquired from public prospectuses and annual reports. The definitions are shown as below.

I. Input variables

1. Number of employees, the sum of employees.
2. E-learning invested costs, the input expenses (equipment and materials) for e-learning of Kaohsiung City Government.
3. Management expenses.

II. Output variables

1. Yearly performance assessment, the yearly performance assessment of personnel in various departments of Kaohsiung City Government.

EMPIRICAL ANALYSIS OF E-LEARNING EFFICIENCY

Analysis of e-Learning Efficiency of the Departments in Kaohsiung City Government

With DEA to evaluate the efficiency, the results could assist in understanding the relative efficiency to e-learning between the departments in Kaohsiung City. When the efficiency=1, the DMU achieves the relative efficiency. When the efficiency<1, the DMU is regarded relatively inefficient. The empirical results, **Table 1**, show that ten departments present relative efficiency on management, including 1. Civil Affairs Bureau, 2. Finance Bureau, 3. Education Bureau, 4. Economic Development Bureau, 5. Marine Bureau, 6. Tourism Bureau, 7. Urban Development Bureau, 8. Labor Affairs Bureau, 9. Department of Health, 10. Information Bureau, and the efficiency achieves 1, showing that the e-learning efficiency of the ten departments reach the ideal state. The rest 13 departments appear worse e-learning efficiency.

Table 1. Relative efficiency of the departments in Kaohsiung City

Sectors in Kaohsiung City	Overall efficiency	Pure technical efficiency	Scale efficiency
Civil Affairs Bureau	1.00	1.00	1.00
Finance Bureau	1.00	1.00	1.00
Education Bureau	1.00	1.00	1.00
Economic Development Bureau	1.00	1.00	1.00
Marine Bureau	1.00	1.00	1.00
Agriculture Bureau	0.83	0.79	0.86
Tourism Bureau	1.00	1.00	1.00
Urban Development Bureau	1.00	1.00	1.00
Public Works Bureau	0.90	0.81	0.85
Water Resources Bureau	0.96	0.95	0.86
Social Affairs Bureau	0.83	0.80	0.88
Labor Affairs Bureau	1.00	1.00	1.00
Police Department	0.70	0.62	0.90
Fire Bureau	0.87	0.82	0.87
Department of Health	1.00	1.00	1.00
Environmental Protection Bureau	0.92	0.90	0.91
Mass Rapid Transit Bureau	0.97	0.95	0.98
Cultural Affairs Bureau	0.99	0.91	1.00
Transportation Bureau	0.83	0.80	0.87
Legal Affairs Bureau	0.97	0.94	0.99
Military Service Bureau	0.99	0.99	0.94
Land Administration Bureau	0.91	0.88	0.92
Information Bureau	1.00	1.00	1.00

Slack Variable Analysis

Regarding the analysis of returns to scale, **Table 2**, ten departments in Kaohsiung City Government reveal constant returns to scale and the e-learning efficiency achieves the optimization. Two departments in Kaohsiung City Government appear decreasing state that the scale should be reduced in order to enhance the marginal returns and improve the e-learning efficiency. The rest eleven departments in Kaohsiung City Government present increasing returns to scale, showing that the scale could be enlarged to enhance the marginal returns and further promote the efficiency.

In regard to Slack Variable Analysis, the improvements for abundant inputs in the departments in Kaohsiung City Government are shown in **Table 2**. Aiming at such departments with abundant inputs, the inputs should be reduced so that the management could achieve the efficiency. Moreover, the ten departments with e-learning efficiency in Kaohsiung City Government have presented the optimal input resources.

Table 2. Improvements for the sectors in Kaohsiung City

Decision-Making Unit (DMU)	Improvement of inputs			Improvement of outputs	Returns to scale
	Number of employees	Costs	Management expenses	Yearly performance	
Civil Affairs Bureau	0	0	0	0	CRS
Finance Bureau	0	0	0	0	CRS
Education Bureau	0	0	0	0	CRS
Economic Development Bureau	0	0	0	0	CRS
Marine Bureau	0	0	0	0	CRS
Agriculture Bureau	-5	-6	-3	-7	DRS
Tourism Bureau	0	0	0	0	CRS
Urban Development Bureau	0	0	0	0	CRS
Public Works Bureau	-3	-3	-1	-2	IRS
Water Resources Bureau	-1	0	0	-1	IRS
Social Affairs Bureau	0	-2	-2	-5	IRS
Labor Affairs Bureau	0	0	0	0	CRS
Police Department	0	-9	-8	-10	IRS
Fire Bureau	0	-3	-1	-2	IRS
Department of Health	0	0	0	0	CRS
Environmental Protection Bureau	0	-1	0	-4	IRS
Mass Rapid Transit Bureau	-1	-1	-2	-3	IRS
Cultural Affairs Bureau	-3	0	0	-3	IRS
Transportation Bureau	-2	0	0	-2	IRS
Legal Affairs Bureau	-4	0	0	-2	DRS
Military Service Bureau	0	-2	-1	0	IRS
Land Administration Bureau	0	-2	-2	-1	IRS
Information Bureau	0	0	0	0	CRS

Data source: Organized in this study

CONCLUSION AND SUGGESTION

According to Kung (2009) and Ma (2010), DMUs are further classified into strong efficiency, marginal efficiency, marginal inefficiency, and distinct efficiency. Strong efficiency shows the efficiency=1 and the slack variable=0, and the DMUs present large strength on exceeding inefficiency. Unless the major change of input and output factors, such sectors could remain the efficiency. Marginal efficiency reveals the efficiency=1 and at least one slack variable≠0. Such sectors could reduce the efficiency below 1 simply by increasing input factors or decreasing output factors. Marginal inefficiency presents the efficiency<1 but >0.9 that the efficiency could easily be enhanced up to 1. When the efficiency<0.9, it is regarded distinctly inefficient. Such sectors might be difficult to become efficient in a short period of time, in which the sectors with the efficiency<0.75 would remain inefficient unless there are major changes in input and output factors.

The efficiencies acquired by DEA and the message received from the variables are classified as in [Table 1](#). The management efficiency of ten DMUs reveals strong efficiency, with the efficiency=1, about 13% of all DMUs,

showing the favorably relative efficiency to e-learning. The management efficiency of eight DMUs appears between 0.9 and 1, regarded as marginal inefficiency, about 2% of all DMUs, presenting the relative efficiency to e-learning being easily enhanced. The e-learning efficiency of five DMUs is lower than 0.9, as distinct efficiency, about 88% of all DMUs, where the e-learning efficiency of Police Department appears the lowest 0.70. From the analyses with DEA, the proportion of the departments in Kaohsiung City Government not achieving Scale efficiency is rather high that the inputs for e-learning should be re-considered and adjusted so as to promote the competitiveness. It is therefore suggested that the relatively inefficient sectors should pay attention to the number of recruitment, the equipment for e-learning, and the inputs of management expenses in order to reduce the over-waste of resources.

REFERENCES

- Bachman, K. (2000). *Corporate e-Learning: Exploring a New Frontier*. WR Hambrecht +Co.
- Chang, C.-C., & Lai, Y.-C. (2009). Efficiency assessment and risk control of Credit Department of Farmers' Associations. *Agricultural Finance Forum*, 42, 33-58.
- Chang, D.-S., & Tseng, K.-C. (2010). Incorporating Value Judgements into Data Envelopment Analysis to Measure the Quality of Public Safety in Taiwan. *Journal of Management & Systems*, 7(3), 283-304.
- Chang, P.-L., Huang, S.-N., & Shen, P.-D. (2009). Measuring the Performance of Social Welfare Agency in Taiwan. *Journal of Management & Systems*, 4(1), 145-160.
- Chang, R.-Y., & Hou, Y.-H. (2011). Best Practice Models of Provincial Hospitals: Evaluating Technical, Allocative, and Overall Efficiency. *Management Review*, 20(4), 1-27.
- Golany, B., & Roll, Y. (1989). An Application Procedure for DEA, *Omega*, 17(3), 237-250.
- Huang, B.-L. (2010). Viewing business online trainings from the development of online learning. *eBusiness Executive Report*, 19, 12-23.
- Huang, X.-N. (2009). On the methods and applications of data envelopment analysis for measuring the efficiency of non-profit organizations. *Cooperation and Development*, 222, 27-35.
- Kung, L.-C. (2009). Performance Evaluation of Taipower's Distribution Technical Sectors with Data Envelopment Analysis. *Chiao Da Management Review*, 3(2), 109-117.
- Lee, C.-H. (2009). The Analysis of Learning Portfolio and Effectiveness Based on Hybrid E-Learning. *Journal of Information management*, 7(2), 81-102.
- Liu, H.-C., Chuang, C.-D., & Lin, J.-C. (2010). An Analysis of the Performance on credit Department with Fishermen Association in Taiwan-Application on Data Envelopment Analysis. *Basic Finance*, 35, 107-134.
- Ma, C.-H. (2010). The Relative Efficiency Evaluation of Military Supply Units. *Taiwan Economic Research*, 251, 1-14.
- Rosenberg, M. A. (2001). *e-Learning: Strategies for Delivering knowledge in the Digital Age*. Columbus, OH: The McGraw Hill Companies, Inc.
- Shull, F. A., Delbecq, A. L., & Curmings, L. L. (1970). *Organizational Decision Making*. McGraw-Hill.
- Su, C.-L., & Yen, H.-M. (2011). A study on relative efficiency assessment of national senior high schools in Taiwan: The application of Data Envelopment Analysis. *Journal of Taiwan Bank*, 51(4), 279-317.
- Tsou, C.-P. (2011). Booming of global e-learning. *Management Magazine*, 312, 87-89.



For print copies of this issue or articles please send an e-mail to:

print@modestum.co.uk



Corporate Governance, Professional Education, and Employee Bonus in High-Tech Industry- Evidence from Taiwan

Lin Wen Hsiang

Department of Tourism / Accounting, I-Shou University, Kaohsiung City, TAIWAN, R.O.C.

Received 24 April 2017 • Revised 3 July 2017 • Accepted 22 August 2017

ABSTRACT

High-tech industry plays the role of motivator in the economic development in Taiwan, revealing that high-tech industry is not simply the most important breadwinner in Taiwan, but also the powerful backing of national competitive advantage under the globally competitive system. High-tech industry requires the engagement of excellent talents, but the staff turnover rate is commonly high. A lot of businesses therefore apply employee bonus and the high development of high-tech industry as the incentives to recruit and retain talents. In this case, it is important for high-tech industry understanding the factor in employee bonus and further discussing the relationship among current corporate governance mechanism, professional education, and employee bonus for the sustainable development. Taking domestic listed high-tech companies as the research objects, the database of Taiwan Economic Journal and Taiwan Patent Gazette are the data sources to collect the companies' financial statement, patent, and stock price data for the empirical research. The research results conclude the significantly positive correlations between 1) corporate governance and employee bonus, 2) professional education and corporate governance, and 3) professional education and employee bonus. Finally, conclusion and suggestions are proposed, expecting to assist high-tech businesses in promoting the employee bonus system.

Keywords: high-tech industry, corporate governance, professional education, employee bonus

INTRODUCTION

In order to reinforce national competitiveness to facilitate the industrial transformation in Taiwan, electronics industry is positively developed as the major niche of national competitiveness. Nevertheless, the development of high technologies requires abundant capitals and high-level manpower. Stock bonus, under the limited capital, is therefore applied to attract oversea talents returning for development. With the support of excellent talents and the government, electronics industry becomes the major power of national development. In the rapid advance of technology, internationalization is the objective pursued by domestic enterprises, and products should be diverse, individualized, and cheap to satisfy customer needs.

In face of the fiercely competitive environment, an enterprise has to constantly think of the coping method to maintain the competitive advantage. Without exceptions, domestic enterprises actively apply various management methods in past years to improve and enhance the business management and expect to adapt to the change of business environment and overcome the fierce competition in the international market for the

© **Authors.** Terms and conditions of Creative Commons Attribution 4.0 International (CC BY 4.0) apply.

Correspondence: Lin Wen Hsiang, *Department of Tourism and Accounting, I-Shou University, No.1, Sec. 1, Syuecheng Rd., Dashu District, Kaohsiung City 84001, Taiwan, R.O.C.*

✉ warren@isu.edu.tw

State of the literature

- Corporate governance as the mechanism which could supervise an enterprise implementing internal and external auditing to ensure the enterprise conforming to the social norms, proceeding relevant businesses & activities, and paying attention to interested parties' benefits.
- All famous high-tech companies have regarded "profit sharing & stock ownership" as a part of employees' salary and consider that employee profit sharing & stock ownership could result in competitive advantage for the enterprise.
- To understand the factors in employee bonus and further discuss the correlations among current corporate governance mechanism, professional education, and employee bonus therefore become the key research motivation and objective in this study.

Contribution of this paper to the literature

- A high-tech could provide the work environment, which allows the employees develop what they learn in the professional education to enhance the professional capability being effectively applied.
- To enhance the competitiveness of a high-tech business, the corporate culture and value good for innovation should be formed and good communication channels and cooperation with members should be established in the organization to create the teamwork environment and facilitate the engagement of employees in various levels.
- A high-tech business should apply corporate governance to combine the business activities which require long-term investment for results, e.g. R&D and innovation.

development and sustainable management. The rapid development of high-tech industry in Taiwan presents critical status in global economic system. High-tech industry also plays the role of motivator in the economic development of Taiwan, showing that high-tech industry is the important breadwinner of Taiwan as well as the powerful backing of national competitive advantage in the globally competitive system. High-tech industry requires the engagement of excellent talents, while the turnover rate is commonly high. Under the shortage of novice and the continuous loss of internal staff, the businesses have tried to attract and retain the best talents in order to maintain the competitiveness. For this reason, a lot of businesses use employee bonus and the high development of high-tech industry as the incentives to recruit and retain talents. Nowadays, about all famous high-tech companies have regarded "profit sharing & stock ownership" as a part of employees' salary and consider that employee profit sharing & stock ownership could result in competitive advantage for the enterprise. To understand the factors in employee bonus and further discuss the correlations among current corporate governance mechanism, professional education, and employee bonus therefore become the key research motivation and objective in this study.

LITERATURE AND HYPOTHESIS

Corporate Governance

Demirtas & Rodgers Cornaggia (2013) defined corporate governance as the mechanism which could supervise an enterprise implementing internal and external auditing to ensure the enterprise conforming to the social norms, proceeding relevant businesses & activities, and paying attention to interested parties' benefits. Madorran & Garcia (2016) divided the measuring variable of corporate governance into national level and corporate level. Hsieh & Wu (2012) indicated that national-level corporate governance involved in the protection of investors (minority shareholders and creditors) in Company Act and security-related regulations as well as the practice effectiveness of such regulations. Corporate-level corporate governance mainly concerned about the major shareholder's cash-flow right, the independence of the board of directors, and the transparency of information. Badolato et al. (2013) inferred corporate governance mechanism as the design and practice through systems, expecting to promote strategic management efficacy and supervision managers' behaviors to ensure the deserved remuneration of external investors (minority shareholders and creditors) and pay attention to other interested parties' (stakeholders) benefits. More specifically, corporate governance was to prevent agencies from damaging

corporate value and reinforce corporate competitiveness and management efficacy in order to guarantee the rights and interests of capital providers and other interested parties. Qian & Yeung (2015) explained the thinking direction of corporate governance mechanism as “how to ensure the investment of capital providers being able to acquire deserved remuneration”. In this case, corporate governance aimed to prevent managers from damaging corporate value and reinforce corporate competitiveness and management efficacy to guarantee the rights and interests of capital providers and other interested parties. There are some common rules for corporate governance; for instance, the corporate governance of Organization for Economic Co-operation and Development (OECD) contains shareholders’ rights, equal treatment to all shareholders, rights and interests of interested parties, information disclosure and transparency, and the responsibilities of the board of directors. Adams & Mehran (2012) considered that a company was composed of interested parties (stakeholders), such as shareholders, employees, creditors, managers, consumers, suppliers, government institutions, and financial institutions, and there were contracts based on the common benefits of all among such interested parties to correct and restrain the behaviors. In short, agency theory mainly discussed the occurrence of agent relationship and the management mechanism.

Referring to Chan et al. (2015), corporate governance in this study contains the following dimensions.

- (1) Manager holding: Van der Colff (2015) indicated that the more shareholding concentrating on the managers in a company, the more the managers’ decisions tended to the maximization of shareholders’ wealth.
- (2) Outside shareholder: Charles et al. (2016) showed two different opinions. “Efficient monitoring hypothesis” indicated that institution investors presented more professional knowledge and techniques to supervise managers than minority shareholders did, and the supervision cost was lower. The increase of institution investors therefore could effectively reduce agent problems, enhance business performance, and present positive intention on the acquisition beneficial to the enterprise.
- (3) Board of director size: Zagorchev & Gao (2015) regarded smaller board of director size could better effectively supervise CEO’s action.

Professional Education

Naiker et al. (2013) stated that professional education was the education proceeded in professional schools to cultivate professional talents. Professional education contained both pre-service education and in-service education. Erkens et al. (2012) mentioned that learners acquired professional theoretical knowledge and rational practical skills through formal and long-term professional education to cultivate the professional ethics stressing on service philosophy and customer benefits. Jizi et al. (2014) indicated that professional education, based on the practice and research, emphasized cultivating student capabilities of specialized knowledge application and sustainable development and the innovative awareness and critical awareness in the practical research. Professional education referred to all activities of an enterprise or an industry to enhance the employees’ knowledge, skills, and attitudes required for specific duties or to cultivate the problem-solving capability (Wang et al., 2012). Beaudoin et al. (2015) pointed out professional education as an organization assisting the employees in enhancing the work abilities through planned and organized measures. Simply speaking, professional education was the skills provided for novices or employees executing the work (Rao & Tilt, 2016). Professional education especially aimed at organizational needs to reinforce the match of needs, strategies, philosophy, and culture between employees and organizations to further promote the employees’ work performance and focus on personal objectives. Education allowed people preparing for various roles played in the future or individual development (Wankeun Oh & Seungho Park, 2015).

Referring to Cho et al. (2013), employees’ professional education generally contains the following dimensions.

- (1) Workplace education: also named employee education, aiming to reinforce employees’ competency and skills and cultivate the excellent occupational attitude and professional knowledge.

- (2) Continuing management education: The middle-level supervisors selected from various departments would take turns for the education so as to deeply know the department businesses and accumulate the management experience to become high-level supervisors in the future.

Employee Bonus

Blaylock (2012) explained bonus as an enterprise allocating certain percentage of profit distribution as the remuneration to the employees; such remuneration was set the allocation ratio in advance according to free agreement; once the ratio was decided, it could not be randomly changed by the employer. Cohen et al. (2014) defined bonus plan that bonus was a part of profits beyond the normal salary of employees (Tan, 2012). Khan et al. (2013) stated that an enterprise shared the profit, according to certain percentage, with employees participating in and operating management, aiming to have the business organization and the employees commonly share the gradual economic interests of the company, i.e. sharing parts of organizational profits with the employees. Aebi et al. (2012) proposed that the premise to practice bonus plans lied in a company being able to objectively measure the organizational output and allocating profits according to the enhanced productivity or reduced costs of employees; the basic concept assumed that the overall business efficiency of the company was related to the common efforts of all employees in the enterprise.

Referring to Lee et al. (2015), employee bonus in this study is measured by the following dimensions.

- (1) Bonus plan: also named profit sharing (or bonus), i.e. sharing profits.
- (2) Ownership plan: also named stock ownership or employee stock ownership plans (ESOPs). Oikonomou et al. (2014) stated that such a system having employees become the shareholders of an enterprise would have the employees undertake more responsibilities of enterprise profit and loss after employee stock ownership plans were practiced for few years. In other words, the employees undertook more risks of the business success and the employees could acquire dividends for the efforts.
- (3) Profit sharing & stock ownership: Filbeck et al. (2013) indicated that profit sharing & stock ownership was the system with bonus and share, connecting bonus plans with ownership plans. The meaning was to divide employee bonus into cash directly given to employees and the distribution of shares (or rights and interests). Profit sharing & stock ownership presents the meaning of bonus and share, allowing employees sharing the profits of the enterprise and acquiring the shareholding to commonly undertake the success of the business that it presents the dual meanings of bonus plan and ownership plan.

Research Hypothesis

Liang et al. (2012) pointed out the higher employees' bonus and allotment, the more directors' remuneration. Chan et al. (2015) indicated the commonness in Taiwan that directors in electronics industry held a concurrent post of manager. Since the directors could simultaneously receive director remuneration and employee bonus, it was considered that a director's remuneration should be positively correlated with employees' surplus bonus. Agrawal & Knoeber (2012) mentioned that a lot of electronics companies regarded employee bonus as the weapon of an enterprise competing with others for talents; some enterprises even set the employee bonus up to 15% of surplus. It therefore appeared the worry of "beneficial for employees, but difficult for shareholders". Qian & Yeung (2015) discussed the positive correlation between employee bonus and corporate governance and discovered that the higher employee bonus would have a company tend to giving more stock dividends and therefore reduce the percentage of cash dividends. For this reason, the following hypothesis is proposed in this study.

H1: Corporate governance shows significantly positive correlations with employee bonus.

Rao & Tilt (2016) regarded professional education as the education based on research, in which professional knowledge was constantly expanded and theories were transformed into practice to enhance the

continuous development of profession. Habib et al. (2013) stated that professional education had the cultivation of management talents not simply stress on the unification of knowing and doing or the unification of theory and practice, but emphasize the cultivation of professional ethics, broad knowledge, and critical thinking and capability to comprehensively enhance the application of talents in the corporate governance. Cho et al. (2013) argued that professional education with stronger professionalism of the professional post required the cultivation with longer time and higher level to complete the compound management talents with production, management, operation, and service. Apparently, professional education was the cultivation of corporate governance aiming at management talents in an enterprise (Wang et al., 2012). The following hypothesis is then proposed in this study.

H2: Professional education presents remarkably positive correlations with corporate governance.

Lee et al. (2015) indicated that an enterprise providing professional education could enhance the employees' coherence and organizational commitment. Harjoto et al. (2015) further proposed that an employee would enhance the productivity and professional capability after receiving professional education. Since professional education presents much assistance in employees that employees receiving more diversified professional education and training hours would show better effectiveness of professional education and work performance, and the received employee bonus was more satisfactory. Zagorchev & Gao (2015) indicated that an employee would present better responsibility and devote more to the work performance after receiving professional education and having better understanding of work contents. In this case, an employee participating in professional education could help the work performance and employee bonus. The following hypothesis is then proposed.

H3: Professional education reveals notably positive correlations with employee bonus.

RESEARCH METHOD

Method Model

The test of goodness-of-fit in LISREL is generally measured with overall model fit (i.e. external quality of model) and internal quality of model. Regarding the test of overall model fit, the evaluation indicators contain (1) "χ² ratio" (Chi-Square ratio), standing for the difference between actual theoretical model and expectation value, which is better less than 3, (2) goodness of fit index (GFI) and adjusted goodness of fit index (AGFI), showing the better goodness-of-fit when closer to 1, (3) root mean square residual (RMR) reflecting "variance of fit residual/covariance mean", which is better less than 0.05, and (4) incremental fit index (IFI), revealing good model fit when being larger than 0.9.

The common evaluation indicators for the internal quality of model in LISREL contain (1) SMC (square multiple correlation) of individual manifest variables, as R² of manifest variables and latent variables, which should be larger than 0.5, (2) component reliability (ρ) of latent variables, as the Cronbach's α of observation indicator of latent variables, which is better larger than 0.6, (3) average variance extracted of latent variable, calculated by the sum of manifest variables R² of a latent variable divided by the number of manifest variables, revealing the percentage of the latent variable being measured with manifest variables, which is better larger than 0.5.

Research Sample and Object

Domestic listed high-tech companies are selected as the research objects, and the database of Taiwan Economic Journal and Taiwan Patent Gazette are the data sources to collect the financial statement, patent, and stock price data for the empirical research. Manufacturers with the major businesses in semiconductor manufacturing, passive component manufacturing, and other electronic part and component manufacturing are covered, such as Taiwan Semiconductor Manufacturing Company, United Microelectronics Corporation, and Lite-On Technology Corporation.

Table 1. Analysis of model

	Evaluation indicator	Criteria	Result
Overall fit	<i>p</i> -value	<i>p</i> -value > 0.05	0.000
	χ^2 /d.f.	< 3	1.183
	GFI	> 0.9	0.976
	AGFI	> 0.9	0.923
	CFI	> 0.9	0.931
	RMR	< 0.05 and lower than 0.025 Excellent	0.011
	RMSEA	0.05~0.08 Good < 0.05 Excellent	0.034
	NFI	> 0.9	0.942
	IFI	> 0.9	0.907

Table 2. SMC between variable and dimension

Corporate governance		
manager holding	outside shareholder	board of director size
0.71	0.73	0.77

Table 3. SMC between variable and dimension

Professional education		Employee bonus		
workplace education	continuing management education	bonus plan	ownership plan	profit sharing & stock ownership
0.75	0.81	0.82	0.84	0.87

Test of Reliability and Validity

Validity refers to the scale of measure which could actually measure the degree of something which a researcher intends to measure. The common types of validity include “content validity” which tends to qualitative test, “criterion validity” which uses the considered external criterion and the correlation coefficient in this test, and “construct validity” which is used for evaluating the consistency of a measurement with other observable variables. The questionnaire in this study is designed based on the past theories and referred to the actual conditions of research objects to ensure the content validity by truly expressing the essence of things and the complete representativeness. Besides, the final communality estimation of Factor Analysis is applied to test the construct validity of questions, where the validity appears in 0.8~0.9, revealing the favorable validity test of the questionnaire.

EMPIRICAL RESULT ANALYSIS

Test of Model Fit

“Maximum Likelihood” (ML) is utilized in this study for the estimation, and the analysis results achieves the convergence. Overall speaking, the indicators of overall model fit pass the test, **Table 1**, thoroughly reflecting the favorable external quality of model.

Test of Path Relationship

In terms of the test of internal model quality, the square multiple correlation (SMC) of manifest variables is higher than 0.5 (**Table 2, 3**), revealing the good measures of latent variables. Furthermore, the component reliability of latent variables, i.e. corporate governance, professional education, and employee bonus, is higher than 0.6, and the average variance extracted of dimensions is higher than 0.5 (**Table 4**). It apparently shows the good internal quality of model.

Table 4. Component reliability and average variance extracted of variable

Item	Corporate governance	Professional education	Employee bonus
component reliability	0.853	0.844	0.868
average variance extracted	0.85	0.82	0.89

Table 5. Analysis of Linear Structural Relations Model

Evaluation item	Parameter/evaluation standard	Result	t
intrinsic fit	corporate governance→employee bonus	0.862	17.51**
	professional education→corporate governance	0.848	10.63**
	professional education→employee bonus	0.853	12.44**

Table 6. Hypothesis test

Research hypothesis	Correlation	Empirical result	P	Result
H1	+	0.862	0.00	Supported
H2	+	0.848	0.00	Supported
H3	+	0.853	0.00	Supported

From the model analysis in **Table 5**, corporate governance presents positive and significant correlations with employee bonus (0.862), professional education shows positive and remarkable correlations with corporate governance (0.848), and professional education appears positive and notable correlations with employee bonus (0.853) that H1, 2, and 3 are supported. The test results of hypotheses are shown in **Table 6**.

CONCLUSION AND SUGGESTION

The research results reveal that corporate governance could affect and further enhance corporate performance, and the proportion of employee bonus issued is affected by business performance of the company. Consequently, it is considered in this study that a company with better corporate governance would increase the proportion of employee bonus. Professional education is the easiest and time-saving way to make changes; besides, promoting professional capability through professional education could enhance employee bonus. Accordingly, employees could actively participate in professional education offered in high-tech businesses and make what they learn become the professional skills so as to effectively enhance the employee bonus.

By organizing the results and findings, practical suggestions are proposed as below.

1. When proceeding professional education, a high-tech business should provide the employees with multiple choices and opportunities to participate in pluralistic education. Furthermore, a high-tech could provide the work environment, which allows the employees develop what they learn in the professional education to enhance the professional capability being effectively applied. In this case, the employees could effectively promote the capability, enhance the satisfaction with the professional education system, and assist the high-tech business in enhancing profits and increasing employee bonus.
2. In the knowledge economy era, the importance of innovation is increasing. To enhance the competitiveness of a high-tech business, the corporate culture and value good for innovation should be formed and good communication channels and cooperation with members should be established in the organization to create the teamwork environment and facilitate the engagement of employees in various levels. To enhance the communication and cooperation in a high-tech organization to promote individual and overall innovation capability, it is suggested in this study that a high-tech business

should cope with the required innovation characteristics, provide diverse professional education, enhance the basis of corporate governance, and establish effective employee bonus mechanisms to induce employees' creativity to further reflect on the performance.

3. A high-tech business should apply corporate governance to combine the business activities which require long-term investment for results, e.g. R&D and innovation, with the long-term incentive system, e.g. employee bonus, to ensure the employees being willing to permanently and continuously devote to the business performance, rather than sacrificing long-term benefits for short-term interests. Particularly, well applying the long-term incentive characteristics of bonus plans would have a high-tech business, which requires R&D, innovative, and high knowledge talents, create better innovative performance.

REFERENCES

- Adams, R. B., & Mehran, H. (2012). Bank board structure and performance: Evidence for large bank holding companies. *Journal of financial Intermediation*, 21(2), 243-267.
- Aebi, V., Sabato, G., & Schmid, M. (2012). Risk management, corporate governance, and bank performance in the financial crisis. *Journal of Banking & Finance*, 36(12), 3213-3226.
- Agrawal, A., & Knoeber, C. R. (2012). Corporate governance and firm performance. In C. R. Thomas & W. F. Shughart II (Eds.), *Oxford Handbook in Managerial Economics*. New York, NY: Oxford University Press.
- Badolato, P. G., Donelson, D. C., & Ege, M. (2013). Audit committee financial expertise and earnings management: The role of status. *Journal of Accounting and Economics*, 58(2-3), 208-230.
- Beaudoin, C. A., Cianci, A. M., & Tsakumis, G. T. (2015). The impact of CFOs' incentives and earnings management ethics on their financial reporting decisions: The mediating role of moral disengagement. *Journal of Business Ethics*, 128(3), 505-518.
- Blaylock, B. S. (2012). Do managers extract economically significant rents through tax aggressive transactions? Working paper, Oklahoma State University.
- Chan, K., Chen, H.-K., Hong, L.-H., & Wang, Y. (2015). Stock market valuation of R&D expenditures – the role of corporate governance. *Pacific-Basin Finance Journal*, 31, 78-93.
- Charles, K., Frank G., & Rajdeep, G. (2016). Washing Away Your Sins? Corporate Social Responsibility, Corporate Social Irresponsibility, and Firm Performance. *Journal of Marketing*, 80(2), 59-79.
- Cho, S. Y., Lee, C., & Pfeiffer, R. J. (2013). Corporate social responsibility performance and information asymmetry. *Journal of Accounting and Public Policy*, 32(1), 71-83.
- Cohen, J. R., Hoitash, U., Krishnamoorthy, G., & Wright, A. M. (2014). The effect of audit committee industry expertise on monitoring the financial reporting process. *The Accounting Review*, 89(1), 243-273.
- Demirtas, K. O., & Cornaggia, K. G. (2013). Initial credit ratings and earnings management. *Review of Financial Economics*, 22(4), 135-145.
- Erkens, D. H., Hung, M., & Matos, P. (2012). Corporate governance in the 2007-2008 financial crisis: Evidence from financial institutions worldwide. *Journal of Corporate Finance*, 18(2), 389-411.
- Filbeck, G., Gorman, R., & Zhao, X. (2013). Barron's most respected companies. *Accounting and Finance*, 53, 623-641.
- Habib, A., Uddin Bhuiyan, B., & Islam, A. (2013). Financial distress, earnings management and market pricing of accruals during the global financial crisis. *Managerial Finance*, 39(2), 155-180.
- Harjoto, M., Laksmana, I., & Lee, R. (2015). Board Diversity and Corporate Social Responsibility. *Journal of Business Ethics*, 132(4), 641-660.
- Hsieh, C. C., & Wu, S. J. (2012). Monitoring the monitors: The effect of banking industry reform on earnings management behavior in an emerging market. *Corporate Governance: An International Review*, 20(5), 451-473.
- Jizi, M. I., Salama, A., Dixon, R., & Stratling, R. (2014). Corporate governance and corporate social responsibility disclosure: Evidence from the US banking sector. *Journal of Business Ethics*, 125(4), 601-615.

- Khan, A., Muttakin, M. B., & Siddiqui, J. (2013). Corporate governance and corporate social responsibility disclosures: Evidence from an emerging economy. *Journal of business ethics*, 114(2), 207-223.
- Lee, K.-H., Min, B., & Yook, K.-H. (2015). The impacts of carbon (CO₂) emissions and environmental research and development (R&D) investment on firm performance. *International Journal of Production Economics*, 167, 1-11.
- Liang, J., Farh, C. I. C., & Farh, J.-L. (2012). Psychological Antecedents of Promotive and Prohibitive Voice: A Two-Wave Examination. *Academy of Management Journal*, 55(1), 71-92.
- Madorran, C., & Garcia, T. (2016). Corporate social responsibility and financial performance: The spanish case. *Responsabilidad social corporativa y desempeño financiero: El caso español*, 56(1), 20-28.
- Naiker, V., Sharma, D. S., & Sharma, V. D. (2013). Do former audit firm partners on audit committees procure greater nonaudit services from the auditor? *The Accounting Review*, 88(1), 297-326.
- Oh, W., & Park, S. (2015). The Relationship between Corporate Social Responsibility and Corporate Financial Performance in Korea. *Emerging Markets Finance & Trade*, 51, 85-94.
- Oikonomou, I., Brooks, C., & Pavelin, S. (2014). The effects of corporate social performance on the cost of corporate debt and credit ratings. *Financial Review*, 49(1), 49-75.
- Qian, M., & Yeung, B. Y. (2015). Bank financing and corporate governance. *Journal of Corporate Finance*, 32, 258-270.
- Rao, K., & Tilt, C. (2016). Board Composition and Corporate Social Responsibility: The Role of Diversity, Gender, Strategy and Decision Making. *Journal of Business Ethics*, 138(2), 327-347.
- Tan, T. K. (2012). Financial distress and firm performance: Evidence from the Asian financial crisis. *Journal of Finance and Accountancy*, 11(1).
- Van der Colff, F. (2015). Predicting financial distress using financial and non-financial variables. *Journal of Economic and Financial Sciences*, 8(1), 243-260.
- Wang, Y. J., Hou, H., & Khan, W. (2012). Foreign institutional ownership and firm dividend payout: the case of Taiwan. *Journal of Emerging Market*, 11, 72-80.
- Zagorchev, A., & Gao, L. (2015). Corporate governance and performance of financial institutions. *Journal of Economics and Business*, 82, 17-41.

<http://www.ejmste.com>



<http://www.ejmste.com>



<https://twitter.com/ejmste>



<https://www.facebook.com/ejmste>



<http://modestum.co.uk/>



publications@modestum.co.uk



OPEN ACCESS

EURASIA Journal of Mathematics Science and Technology Education
ISSN: 1305-8223 (online) 1305-8215 (print)
2017 13(9):6313-6323
DOI: 10.12973/eurasia.2017.01066a



How to Promote Knowledge Sharing among EVC Members? — Based on Interactive Perspective of Modified TAM Model

Shi-Jian Wu

College of Economics and Management, Shandong University of Science and Technology, CHINA

Guo-Xin Liu

College of Economics and Management, Shandong University of Science and Technology, CHINA

Xin-Min Liu

College of Economics and Management, Shandong University of Science and Technology, CHINA

Zhong-Bao Zhou

School of Business Administration, Hunan University, CHINA

Received 30 April 2017 • Revised 26 July 2017 • Accepted 2 September 2017

ABSTRACT

Compared with traditional learning methods, Educational virtual community has the incomparable advantage of knowledge diffusion with high efficiency and wide range. It is conducive to the knowledge acquisition and innovation of learners, and it provides a platform for learners to change their roles from the passive recipient of information to the main participant of knowledge acquisition. Based on the interactions between users' personal, technical and organizational characteristics, a modified technology acceptance model was presented in this paper to explain the willingness and behavior of knowledge sharing in EVC in order to propose and validate the effects of perceived usefulness, perceived ease of use, and psychological ownership on the willingness and behavior of knowledge sharing. In this research, the methods of interviewing and questionnaires with 40 questions included have adopted and 334 members from 32 educational virtual communities were surveyed. Based on the 326 valid samples, the hypothesis of research be tested with software SPSS 22.0 by structural equation model. Empirical research found that: Perceived usefulness and perceived ease of use has remarkable positive impact on knowledge sharing willingness, and perceived usefulness with greater function can significantly promote perceived ease of use; psychological ownership can affect not only the knowledge sharing behavior through the knowledge sharing willingness, but also the behavior directly; the knowledge sharing willingness plays a fully mediating role between perceived usefulness and knowledge sharing behavior, while there exist the significant mediating effects between perceived ease of use and knowledge sharing behavior, and between psychological ownership and knowledge sharing behavior. Based on the conclusion of this research, the interactions between different factors should be taken into account in order to advance the willingness and behavior of knowledge sharing among EVC members and the perceived usefulness, perceived ease of use and psychological ownership level of community members should be proactively promoted.

Keywords: educational virtual community (EVC), knowledge sharing, psychological ownership, perceived usefulness; perceived ease of use

© **Authors.** Terms and conditions of Creative Commons Attribution 4.0 International (CC BY 4.0) apply.

Correspondence: Shi-Jian Wu, Associate Professor, *College of Economics and Management, Shandong University of Science and Technology, Qingdao, China. Address to No.579 Qianwangang Road, Huangdao District, Qingdao city 266590, P.R. China. Tel: +86-532-8605-7027.*

✉ everwsj@163.com

State of the literature

- As a comprehensive, multi-functional teaching and learning environment based on E-learning, EVC is of great significance in the enhancement of learners' interest and the promotion of knowledge exchange and innovation, which is the important direction of educational development in the future.
- The high-quality knowledge information actively shared by community members is the key to the existence of EVC; but in reality, the circumstances of insufficient contribution by members and the shortage of knowledge supply affect the development of EVC.
- There are a lot of factors affecting knowledge sharing of EVC members, so in order to promote the willingness and behavior of knowledge sharing of EVC members, not only should the functions of various factors be improved, but also the interactions between community users, community systems, and organizational relationships should also be considered.

Contribution of this paper to the literature

- Based on the interactions between users' personal characteristics, technical characteristics and organizational characteristics, a modified technology acceptance model was proposed in this paper to provide a new perspective for the explanation of the willingness and behavior of EVC members' knowledge sharing.
- Perceived usefulness and perceived ease of use can positively affect knowledge sharing willingness, and perceived usefulness with greater function can significantly promote perceived ease of use; psychological ownership can affect not only the knowledge sharing behavior through knowledge sharing willingness, but can also affect the behavior directly.
- Based on the constructed theoretical model and empirical conclusions, the suggestions to improve knowledge sharing in EVC were offered from the enhancement of EVC members' perceived usefulness, perceived ease of use, psychological ownership level, etc.

INTRODUCTION

Jerome Bruner pointed out: "the acquisition of knowledge is an active process, so learners should be the active participant in the process of knowledge acquisition rather than the passive recipients of information". With the advent of knowledge economy and the Internet era, the emergence of education virtual community (EVC) provides a platform for learners to change their roles from passive recipients of information to the main participant of knowledge acquisition, resulting in the profound transformation of the content and form of "knowledge". Unlike general learning community, the educational virtual community is a comprehensive, multi-functional teaching and learning environment based on E-learning. In educational virtual community, the network technology across time and space provides a free and open teaching environment for learners, and for the common education goal, the community members (mainly including teachers and students) compose the various types of learning communities to obtain knowledge through special subject research and study, interactive collaboration and resource sharing so as to complete the task of learning together and form an interactive relationship in the process.

As a virtual community of interest, EVC is incomparable to traditional learning methods, and has the advantages of knowledge diffusion with high efficiency and wide range. Under the guidance of common education goal, common learning concept and common learning needs, learners communicate with each other, establish a trust relationship with each other, and actively carry out the collaborative sharing of knowledge to achieve the continuous improvement of self-cognitive ability and practical ability. Efficient knowledge sharing is the foundation of the survival and development of educational virtual communities. On the one hand, all the resources within EVC come from the knowledge shared by users, so the personal abilities of learners are improved through effective knowledge sharing, thus promoting the development of organization; on the other hand, the main purpose of learners to carry out community communication is to obtain various learning resources, and realize the transformation, absorption and integration of knowledge through cooperative and autonomous learning to improve knowledge and skills. Therefore, enhancing the willingness and behavior of learners to share knowledge,

Table 1. Basic Theory of EVC Knowledge Sharing

Theoretical perspective	Main points	Representative literature
Social cognitive theory	Knowledge sharing behavior is affected by personal motivation and self-efficiency. The better the expectations of the results are, the more the user's knowledge sharing willingness can be stimulated; the higher the self-efficiency of user is, the better the knowledge sharing behavior is.	Hsu et al. (2007); Chou et al. (2009); Chen & Hung (2010); Tseng & Kuo (2014); Shang (2012)
Social capital theory	EVC is a network of social relationship, and the main purpose of users to share knowledge is to obtain the relational, structural and cognitive capitals from the community. Knowledge sharing is affected by the intensity of social relationship, reciprocity and identification between members.	Nahapiet & Ghoshal (1998); Wasko & Faraj (2005); Chang & Chuang (2011); Zhao et al. (2012); Tseng & Kuo (2014)
Social exchange theory	Knowledge sharing is a social exchange behavior for benefit or repay, which can be promoted by reciprocity and equity.	Paxton (1999); Seers (2014); Blaud (2004); Kankanhalli (2005); Li (2013)
Social behavior theory	Knowledge sharing is an altruistic behavior, and psychological capital, trust, organizational commitment, etc., are the main factors affecting sharing willingness.	Chou & Chang (2008); Chao et al. (2010); Yu (2014)
Knowledge governance theory	Knowledge characteristics, organizational structure, formal and informal knowledge governance arrangements can affect the willingness and effect of knowledge sharing in the organization.	Nonaka (1994); Zander & Kogut (1995); Grandori (2001); Foss (2008, 2012)
Planned behavior theory	The generation of behavior directly depends on the intention of a person to perform a particular action. Subjective norms and perceived behavioral control are positively related to users' willingness to share knowledge.	Ajzen (1988,1991); Chou & Chang (2008); Chao et al. (2010); Xia (2015)
Technology acceptance model	The characteristics of the network system will influence user's cognition and behavior. Perceived usefulness and perceived ease of use of virtual communities are the key factors for users to accept this new type of tool for information exchange.	Davis (1989,1993); Adams (1993); Zhang (2003); Yang (2011); Chiu (2011)

promoting the dissemination and transformation of knowledge within the community, and ultimately creating new knowledge are the foundation of sustainable development of EVC.

However, the actual research shows that most contribution of EVC users exist within the "90-9-1" phenomenon; that is to say, 90% of the users basically do not contribute, 9% of the users contribute occasionally, and only 1% of the users contribute often. The low contribution rate and the decline of participation willingness have become the key to restrict the development of EVC, so webmasters and educational organizers need to figure out the factors that affect users' knowledge sharing behavior so as to take effective measures to enhance users' participation and knowledge sharing willingness, thus ultimately enhancing the community value and realizing the goal of education. Unlike the existing researches that focus on the interaction between user and characteristics of knowledge, a modified technology acceptance model was proposed in this paper based on the interactions between users' personal characteristics, technical characteristics and organizational characteristics, and the model was carried out with empirical test to explain the factors that affect the willingness and behavior of EVC knowledge sharing, and some suggestions to enhance the level of knowledge sharing in EVC were also offered.

THEORETICAL BASIS AND MODEL CONSTRUCTION

Knowledge sharing is a process of knowledge exchange, which includes four factors; namely, knowledge, medium, recipient of knowledge, and knowledge-owner. In this process, the owner of knowledge expresses tacit and explicit knowledge in some form, which were shared to the recipients through medium, in order to realize the dissemination and transformation of knowledge between different subjects, and then ultimately create new knowledge and improve the knowledge level of the organization. Based on the existing researches, the theories related to knowledge sharing of EVC user and influencing factors mainly involve social cognitive theory, social capital theory, planned behavior theory, knowledge governance theory, etc., as shown in [Table 1](#).

According to the above literatures, it is found that there are four main factors affecting user knowledge sharing: knowledge characteristics, organizational characteristics, individual characteristics, and technical

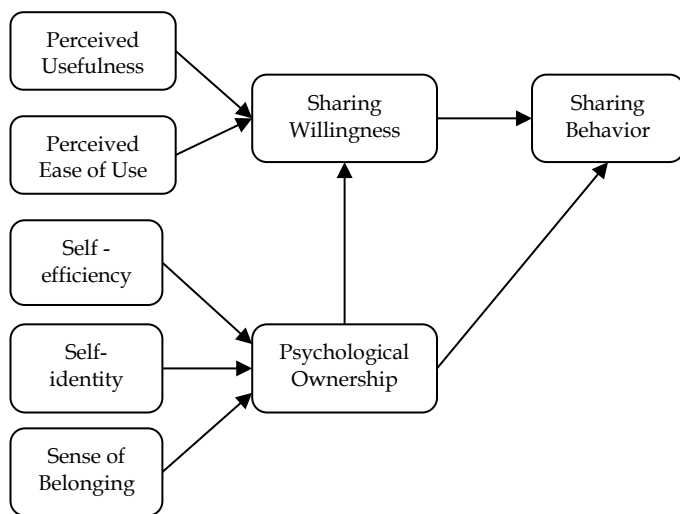

Figure 1. Modified TAM and Influencing Factors of EVC Knowledge Sharing

characteristics. Among them, the knowledge characteristics reflect the influence of complexity, fuzziness, embedability, codability, viscosity and distribution of knowledge on sharing; organizational characteristics discuss the influence of organizational structure, organizational culture, organizational climate, organizational system, trust relationship, leadership style on sharing willingness; individual characteristics reflect the influence of individual competence, individual motivation, self-efficiency and interactive relationship of knowledge transmitters and recipients of knowledge in EVC; technical characteristics as the physical basis of community and the transmission medium of knowledge reflect the space and means of knowledge sharing, which determine the convenience of knowledge diffusion, and the availability as well as usefulness of knowledge acquisition in community.

Unlike general virtual learning community, EVC with teachers and students as main users has definite learning purpose and cultural commonality, and the codability of shared knowledge is also relatively strong. Knowledge sharing behavior in EVC is a process in which two or more users in the community involve knowledge supply and reception, while in this process, users need to exchange information and knowledge with other users by means of electronic equipment, and perceived usefulness and perceived ease of use of the network technology have an important impact on their willingness to participate. Therefore, the influences of knowledge characteristics, individual characteristics, organizational characteristics and technical characteristics on knowledge sharing behavior in EVC are not at the same level. The success of knowledge sharing depends on the quantity and quality of interaction between users, and the willingness and ability of users to apply knowledge. Among them, the user's psychology, attitude and ability play a direct role, and the influences of knowledge characteristics and organizational characteristics are not critical, which are reacted by affecting user's personal characteristics. Attention is fixed on the interactions of users' individual characteristics, technical characteristics and organizational characteristics due to this characteristic of EVC knowledge sharing, thus a modified technology acceptance model was proposed in this study to explain the influencing factors of EVC knowledge sharing (as referred to in **Figure 1**).

In the above model, the knowledge sharing behavior of EVC user firstly depends on his intention of knowledge sharing; that is to say, knowledge can be communicated and transformed in EVC only when the user is willing to share his knowledge. The knowledge sharing willingness of user is mainly affected by the technical characteristics of EVC system, user's personal characteristics and organizational characteristics. Based on the classic technology acceptance model (TAM), the interaction between personal characteristics of user and technical characteristics of system can be described in two aspects including the perceived usefulness that reflects the extent to which the user considers the use of EVC to improve his effectiveness of knowledge exchange and the perceived ease of use that refers to the extent to which users think it is easy to share knowledge by using EVC. The interaction

between user's personal characteristics and organizational characteristics mainly reflects the social interaction characteristics of EVC knowledge sharing and acquisition, which can be explained by the theory of psychological ownership. In the process of EVC knowledge sharing, the users complete the acquisition, absorption and construction of knowledge through the communication and cooperation with each other, which not only helps to improve learner's cognitive level and self-efficacy, but also effectively improves user's willingness to participate and sharing motivation with the improvement of personal cognitive level and the enhancement of social presence, and then the community has become a place for members to engage in emotional communication and collaborative learning, thus resulting in the friendly and cooperative atmosphere with good senses of belonging and identity. Self-efficacy, sense of belonging and self-identity as the important factors affecting users' knowledge sharing are the concentrated reflection of psychological ownership in EVC knowledge sharing. Self-efficacy refers to user's degree of confidence in being able to engage in knowledge sharing behavior; sense of belonging refers to the emotional attachment of users to EVC, namely, the psychological state that put yourself in the virtual community of EVC; self-identity means that the user can psychologically identify with community value that will be connected with self-identity so as to find their own position in EVC and set up personal label.

RESEARCH HYPOTHESIS

Influence of Perceived Usefulness and Perceived Ease of Use on EVC Users' Willingness of Knowledge Sharing

Perceived usefulness is the degree to which users consider academic virtual communities to improve their learning performance, and perceived ease of use is the ease of users using academic virtual communities. The technical characteristics of EVC affecting user's perception of community usefulness and ease of use, can determine user's willingness to share knowledge, thus indirectly affecting user's knowledge sharing behavior. The success of knowledge sharing with user as main body is affected by the technical operation level of knowledge contributor (Wask & Faraj, 2005), and the ease of use and the ease of learning of technology should be paid attention to because of the difference in information capacities of virtual community members (Cheung, 2004). Ease of use can increase the speed of knowledge exchange among members and save time for knowledge exchange, so users' willingness of knowledge sharing could be greatly improved when they think EVC is easy to use; and the usefulness of this system perceived by user will have an impact on the intention of continued use through the satisfaction with information technology. Perceived usefulness and ease of use are the important reasons for promoting the generation of users' willingness (Zhao, 2010), and the knowledge sharing of actual users and potential users is affected by perceived usefulness and ease of use. At the same time, the TAM model proposed by Davis (1989), the TAM2 model proposed by Venkatesh (2000) and the UTAUT model have verified that perceived ease of use has a positive effect on perceived usefulness. The proposed research hypotheses H1, H2 and H3 are as follows:

- H1:** Perceived ease of use has a positive effect on perceived usefulness;
- H2:** Perceived usefulness has a positive effect on knowledge sharing willingness;
- H3:** Perceived ease of use has a positive effect on knowledge sharing willingness.

Influence of Psychological Ownership on EVC Users' Willingness of Knowledge Sharing

The concept of psychological ownership proposed by Pierce et al. (2004) originates from the study of organizational behavior about employee stock ownership plan, which is defined as an experience of possession; namely, "the state that an individual feels the object (of psychological ownership) seems to be owned by him or her". Furby (1991) pointed out that this psychological level of ownership is an experiential sense of possession, which enables people to regard possession as an extension of self, and then affects attitudes, motivations, and behaviors of people. Wilpert et al. (1991) found that employee's psychological ownership of an organization arouses the altruism spirit of the employee, and the employee may initiatively help others, care for the organization, share knowledge to benefit the organization. Furby (1978) pointed out in the research that psychological ownership

would make individuals generate the willingness and behavior to improve organizational performance, such as knowledge sharing, by stimulating the individual's sense of responsibility towards the organization. Han (2010) and others believed that the individual will be more willing to invest time and effort to participate in the virtual community to share knowledge and make contribution under the influence of psychological ownership that can directly or indirectly affect the individual's knowledge sharing behavior. The proposed research hypotheses H4 and H5 are as follows:

H4: Psychological ownership has a positive effect on EVC user's willingness of knowledge sharing;

H5: Psychological ownership has a positive effect on user's behavior of knowledge sharing.

Knowledge Sharing Willingness Determines Sharing Behavior

The willingness to share knowledge is a behavioral intention of EVC users to share knowledge, which does not necessarily lead to knowledge sharing. Willingness and behavior are likely to deviate from each other under different external conditions. Based on the TAM model and the extended TAM2 model proposed by Venkalesh & Davis (2000), it can still be assumed that the knowledge sharing behavior of EVC users is determined by their sharing willingness, and the following hypothesis H6 can be obtained:

H6: EVC user's willingness of knowledge sharing has a positive effect on knowledge sharing behavior.

RESEARCH METHODS AND VARIABLE MEASUREMENTS

The method of questionnaire investigation was adopted in this study and all the variables adopted validated scales to ensure the reliability and validity of the questionnaire. Among them, the scales including 8 items of perceived usefulness and perceived ease of use referred to the scales of Davis (1989) and Dabholkar & Bagozzi (2002); the scale including 5 items of sharing intention referred to the scales designed by Cho (2010); the scale including 6 items of sharing behavior referred to the scale designed by Shi (2010), Liu (2010) and others. Psychological ownership was measured mainly from three dimensions including self-efficacy, self-identity and sense of belonging, among which, the scale including 5 items of self-efficacy referred to the scale designed by Kankanhalli et al. (2005); the scale including 4 items of self-identity referred to the scale designed by Han (2010); the sense of belonging including 4 items referred to the scale designed by Avey et al. (2009). All scales were measured by using five-point numerical value of Likert, 1-5, respectively, "very disagree", "relatively disagree", "general", "relatively agree", and "quite agree"; that is to say, the higher the score is, the more the description of this item is agreed.

The respondents were registered users who were and are using EVC, including students, teachers and parents. A total of 334 questionnaires were recovered and 326 valid questionnaires were obtained with the effective recovery rate of 97.6% after eliminating the unqualified questionnaires with obvious tendency. The statistical information about respondents is shown in **Table 2**.

As shown in **Table 2**, the proportion of men and women who participated in the survey was relatively average with the concentrated age of under 25 years old, accounting for 83.74%; in terms of registered identity, the students in high school and university as the main part of registered users accounted for 88.83%, and there were also some teachers and parents; 82.39% of the respondents visited EVC 1-3 times a week, indicating the user's frequency of use is lower with low activity.

Table 2. Basic Information about Respondents

Demographic variables		Number of people	Percentage (%)
Gender	Male	154	46.31
	Female	172	53.69
Age	< 18 years old	216	66.26
	18-25 years old	57	17.48
	26-35 years old	24	7.36
	36-45 years old	18	5.52
	> 45 years old	11	3.37
Registered identity	Middle school student	8	2.45
	High school student	205	62.88
	College students and above	52	15.95
	Teachers	37	11.35
	Parents and others	24	7.36
Number of weekly access	≤1 times	52	15.95
	2-3 times	184	56.44
	4-6 times	48	14.72
	7-9 times	25	7.67
	≥10 times	17	5.21
Time to join the community	less than 1 month	95	29.14
	1-6 months	59	18.10
	6-12 months	51	15.64
	1-3 years	89	27.30
	over 3 years	32	9.82

ANALYSIS OF RESEARCH RESULT

Reliability and Validity Test

The reliability of each scale was tested by using SPSS 22.0 software, while the internal consistency reliabilities of perceived usefulness, perceived ease of use, self-efficacy, self-identity, sense of belonging, sharing willingness and sharing behavior are all greater than 0.7, and the Cronbach's α values of sub variables and overall scale were between 0.777-0.955, indicating that the internal consistency of the scale is higher with better reliability, which is suitable for the next step of research. The validity was measured from two aspects including factor load value (loading), which was between 0.625-0.867, and average extraction variance (AVE), which was between 0.533-0.678, and both of them were greater than 0.5 with better convergent validity. The discriminant validity was tested by comparing the square root of AVE and the correlation coefficient between variables. If the square root of AVE of a variable is greater than all the correlation coefficients associated with the variable, the discriminant validity of the variable is proved to be good. The correlation coefficients between variables are shown in [Table 3](#). The square roots of AVE of all variables are greater than the correlation coefficients between related variables, and the discriminant validity of the model is better.

Table 3. Mean Value, Standard Deviation and Correlation Coefficient of Variable

Mean Value	M	SD	1	2	3	4	5	6	7
Perceived usefulness	3.801	0.644	0.801						
Perceived ease of use	3.873	0.629	0.408**	0.736					
Self-efficacy	3.532	0.611	0.548**	0.587**	0.804				
Self-identity	3.351	0.691	0.408**	0.411**	0.589**	0.778			
Sense of belonging	3.361	0.679	0.496**	0.413**	0.378**	0.423**	0.755		
Sharing willingness	3.911	0.611	0.538**	0.362**	0.361**	0.407**	0.410**	0.782	
Sharing behavior	3.490	0.627	0.545**	0.553**	0.384**	0.344**	0.567**	0.329**	0.730

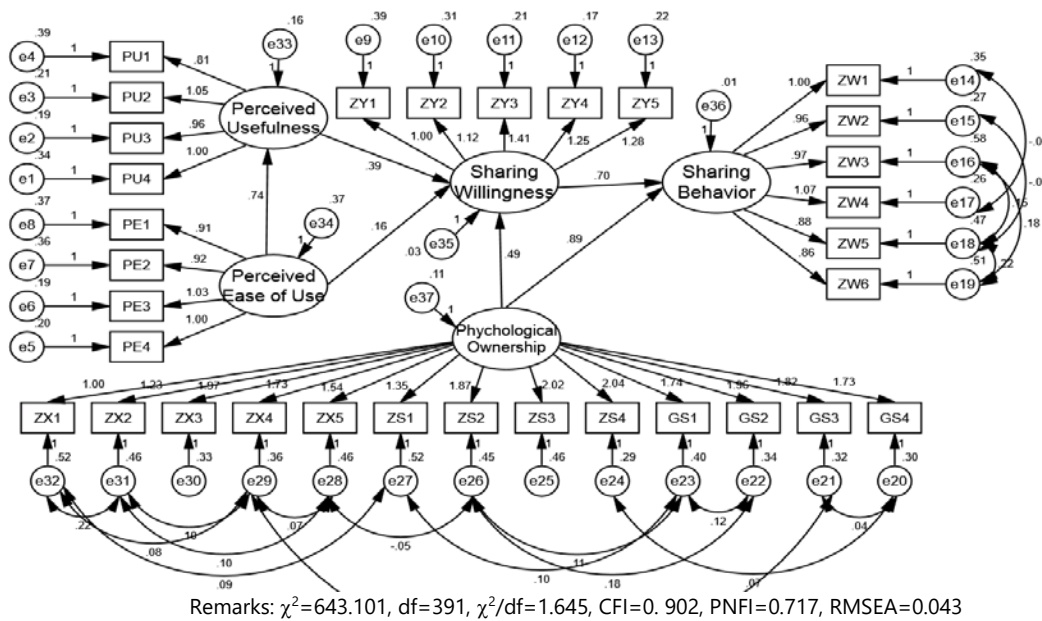

Figure 2. Modified Model Diagram

Multiple linear problems may exist due to the higher correlation coefficient between individual variables, so it is necessary to test whether there is a serious interdependence between the model variables. SPSS 22.0 was used to test the variables, and the results showed that VIF (variance inflation factor) is between 1.845-3.356 and less than 10; the tolerance is between 0.256-0.573 and more than 0.1 without multiple linear relationships. According to the test by the Harman single factor, it was found that the first principal component obtained without rotation was within the acceptable limits, and there was no common variance problem.

Descriptive Statistical Analysis and Correlation Analysis

The mean values, standard deviations, and Pearson correlation coefficients between variables are shown in Table 3, and it can be concluded from Table 3 that there are the significant correlations between the variables in this study, so the hypotheses can be preliminarily supported.

Structural Equation Modeling

Based on the reliability and validity tests with the technology acceptance factor constructed between them, the relationship model between psychological ownership and sharing behavior, and the research hypotheses, AMOS 20.0 was used to establish and modify the initial model. The ideal fitting effect of the model is achieved after modification, as shown in Figure 2 and Table 4.

Table 4. Estimation Results of Path Coefficient and Factor Loading in Modified Model

	Estimate	S.E.	C.R.	P	Corresponding hypothesis	Test result
Perceived usefulness ← Perceived ease of use	0.725	0.070	10.301	***	H1	Getting support
Sharing willingness ← Perceived usefulness	0.392	0.067	5.878	***	H2	Getting support
Sharing willingness ← Perceived ease of use	0.162	0.050	3.248	***	H3	Getting support
Sharing willingness ← Psychological ownership	0.480	0.099	4.876	***	H4	Getting support
Sharing behavior ← Psychological ownership	0.701	0.095	7.410	***	H5	Getting support
Sharing willingness ← Sharing behavior	0.882	0.155	5.694	***	H6	Getting support

Table 5. Result of Mediating Effect Test

Path	$Y = cX + e_1$	$M = aX + e_2$	$Y = c'X + bM + e_3$	
	c	a	c'	b
Perceived usefulness → sharing willingness → sharing behavior	0.536***	0.630***	0.135	0.636***
Perceived ease of use → sharing willingness → sharing behavior	0.641***	0.754***	0.225***	0.552***
Psychological ownership → sharing willingness → sharing behavior	0.837***	0.685***	0.647***	0.278***

Mediating Effect Test

The SPSS 22.0 was adopted to test the mediating effect of knowledge sharing willingness with reference to the testing idea of Wen et al. (2014), as shown in **Table 5**. It can be seen that knowledge sharing willingness plays a complete mediating role between perceived usefulness and knowledge sharing behavior, and plays a significant mediating role between perceived ease of use and knowledge sharing behavior, and between psychological ownership and knowledge sharing behavior.

DISCUSSION

As a comprehensive, multi-functional teaching and learning environment based on E-learning, EVC is of great significance in the enhancement of learners’ interest and the promotion of knowledge exchange and innovation, which is the important direction of educational development in the future. There are a lot of factors affecting knowledge sharing of EVC members, so in order to promote the willingness and behavior of knowledge sharing of EVC members, not only should the functions of various factors be improved, but also the interactions between community users, community systems, and organizational relationships should be considered. Based on the interactions between users’ personal characteristics, technical characteristics and organizational characteristics, a modified technology acceptance model was proposed in this paper to explain the willingness and behavior of knowledge sharing in EVC, in order to propose and validate the effects of perceived usefulness, perceived ease of use, and psychological ownership on the willingness and behavior of knowledge sharing.

In order to increase the willingness and behavior of knowledge sharing of EVC members, and promote the sustainable healthy development of EVC, the following measures can be taken: The first is to enhance the ease of use of EVC websites. The user’s willingness to share knowledge is affected by the friendliness of the EVC operating interface and the convenience of the conditions for sharing. Managers should be user centric, improve the ease of operation and the friendliness of interface, and regularly maintain community websites to enhance user

access and knowledge sharing experience. The second is to strengthen the user's perception of usefulness. The usefulness of EVC embodies in the quality and the level of provided knowledge, and the learners are more willing to share knowledge when they feel that the educational virtual community can effectively meet the content requirements of their learning. EVC administrators can increase the attraction and improve the level and quality of knowledge by inviting well-known educational scholars, outstanding students and others to enter the site; regularly conduct the activities of thematic exchange, learning and discussion or knowledge contest to enhance user's interest of participation and attract more learners to join; strengthen the classification management of knowledge in EVC, improve the capability and search ability of knowledge through the electronic whiteboard, mind map and other software, and enhance the perceived usefulness of EVC knowledge. Finally, improve the psychological ownership of EVC users. The empirical test of the three dimensions of psychological ownership shows that users are more willing to share knowledge with more confidence in their abilities, stronger emotional attachment to EVC and more sense of personal existence. EVC managers can enhance learners' willingness and behavior by improving their sense of community belonging, sense of community attachment, identification of community identity and self-efficacy, for example, optimize community hierarchy and provide higher privilege level for the members who can share the knowledge with high quality so as to strengthen their self-identity; set up reward points and evaluation system, and the member who is willing to help others and actively share knowledge is rewarded with points; strengthen emotional connection and trust relationship of community, create a good learning atmosphere and fair mechanism and enhance the member's psychological sense of "ownership".

CONCLUSION

Based on the interactions between users' personal characteristics, technical characteristics and organizational characteristics, according to the educational community characteristics of EVC, a modified technology acceptance model was proposed in this study to explain the influencing factors of EVC knowledge sharing, which has validated the positive effect of the interactions between individual characteristics and technical characteristics, and between individual characteristics and organizational knowledge sharing behavior, as well as the mediating role of knowledge sharing willingness in technology acceptance factor and psychological ownership. Empirical research found that: Perceived usefulness and perceived ease of use can positively affect knowledge sharing willingness, and perceived usefulness with greater function can significantly promote perceived ease of use; psychological ownership can affect not only the knowledge sharing behavior through the knowledge sharing willingness, but also affect the behavior directly; the knowledge sharing willingness plays a fully mediating role between perceived usefulness and the knowledge sharing behavior, while there exists significant mediating effects between perceived ease of use and knowledge sharing behavior, and between psychological ownership and knowledge sharing behavior. In order to promote the willingness and behavior of knowledge sharing among EVC members, the interactions between different factors should be taken into account, and the perceived usefulness, perceived ease of use and psychological ownership level of community members should be positively promoted.

ACKNOWLEDGEMENTS

This paper was supported by Young and Middle-Aged Scientists Research Awards Fund of Shandong Province (Grant No. BS2013SF019), Postdoctoral Science Foundation of China (Grant No. 2014M551937), MOE (Ministry of Education in China) Project of Humanities and Social Scienceson Youth Fund Project (Grant No. 12YJC790155), Graduate education innovation program of Shandong University of Science and Technology.

REFERENCES

- Avey, J. B., Avolio, B. J., Crossley, C. D., & Luthans, F. (2010). Psychological ownership: theoretical extensions, measurement and relation to work outcomes. *Journal of Organizational Behavior*, 30(2), 173-191. doi:10.1002/job.583
- Bhattacharjee, A. (2001). An empirical analysis of the antecedents of electronic commerce service continuance. *Decision Support Systems*, 32(2), 201-214.

- Chen, C. J., & Hung, S. W. (2010). To give or to receive? Factors influencing members' knowledge sharing and community promotion in professional virtual communities. *Information & Management*, 47(4), 226-236. doi:10.1016/j.im.2010.03.001
- Chen, M. H. (2015). Research on the Willingness of Students' Sustainable Knowledge Sharing in Academic Virtual Community. *Information and Documentation Services*, 36(1), 41-47.
- Cheung, C. M. Y., Shek, S. P. W., & Sia, C. L. (2004). Virtual Community of Consumers: Why People Are Willing to Contribute. *Proceedings of the 8th Pacific Asia Conference on Information Systems*, 2100-2107.
- Chou, C. H., Wang, Y. S., & Tang, T. I. (2015). Exploring the determinants of knowledge adoption in virtual communities: a social influence perspective. *International Journal of Information Management*, 35(3), 364-376. doi:10.1016/j.ijinfomgt.2015.02.001
- Davis, Fred D. (1989). Perceived usefulness, perceived ease of use, and user acceptance of information technology. *Society for Information Management and the Management Information Systems Research Center*. doi:10.2307/249008
- Furby, L. (1978). Possession in humans: exploratory study of its meaning and motivation. *Social Behavior & Personality an International Journal*, 6(1), 49-65. doi:10.2224/sbp.1978.6.1.49
- Gang, K. W., & Ravichandran, T. (2015). Exploring the determinants of knowledge exchange in virtual communities. *IEEE Transactions on Engineering Management*, 62(1), 89-99. doi:10.1109/TEM.2014.2376521
- Huang, W., & Zhang, P. (2016). Research on the influencing factors of knowledge sharing behavior of virtual community users. *Information Science*, 34(4), 68-73.
- Jin, H. (2015). Research on the mechanism of knowledge sharing of college teacher education blog based on DTPB - an empirical study from real users and potential users. *Journal of Intelligence* (10), 175-182.
- Nielsen, J. (2006a). Participation inequality: encouraging more users to contribute. *Quaderns De Filologia Estudis Literaris*, 2688(3), 11-25.
- Nielsen, J. (2006b). The 90-9-1 Rule for Participation Inequality in Social Media and Online Communities. Retrieved from <http://www.nngroup.com/articles/participation-inequality>.
- Pierce, J. L., Kostova, T., & Dirks, K. T. (2001). Toward a theory of psychological ownership in organizations. *Academy of Management Review*, 26(2), 298. doi:10.5465/AMR.2001.4378028
- Han, T. S., Chiang, H. H., & Chang, A. (2010). Employee participation in decision making, psychological ownership and knowledge sharing: mediating role of organizational commitment in Taiwanese high-tech organizations. *International Journal of Human Resource Management*, 21(12), 2218-2233. doi:10.1080/09585192.2010.509625
- Venkatesh, V., & Davis, F. D. (2000). A theoretical extension of the technology acceptance model: four longitudinal field studies. *Management Science*, 46(2), 186-204. doi:10.1287/mnsc.46.2.186.11926
- Wasko, M. L., & Faraj, S. (2005). Why should I share? Examining social capital and knowledge contribution in electronic networks of practice. *MIS Quarterly*, 29(1), 35-57.
- Yang, S. C., & Farn, C. K. (2009). Social capital, behavioral control, and tacit knowledge sharing – a multi-informant design. *International Journal of Information Management*, 29(3), 210-218. doi:10.1016/j.ijinfomgt.2008.09.002
- Yao, C. Y., & Fang, Y. C. (2015). Understanding social capital, team learning, members' e-loyalty and knowledge sharing in virtual communities. *Total Quality Management & Business Excellence*, 26(5-6), 619-631. doi:10.1080/14783363.2013.865918
- Yilmaz, R. (2016). Knowledge sharing behaviors in e-learning community: exploring the role of academic self-efficacy and sense of community. *Computers in Human Behavior*, 63, 373-382. doi:10.1016/j.chb.2016.05.055
- Zhang, Y., Fang, Y., Wei, K. K., & Chen, H. (2010). Exploring the role of psychological safety in promoting the intention to continue sharing knowledge in virtual communities. *International Journal of Information Management*, 30(5), 425-436. doi:10.1016/j.ijinfomgt.2010.02.003



For print copies of this issue or articles please send an e-mail to:

print@modestum.co.uk



OPEN ACCESS

EURASIA Journal of Mathematics Science and Technology Education
ISSN: 1305-8223 (online) 1305-8215 (print)
2017 13(9):6325-6335
DOI: 10.12973/eurasia.2017.01067a



A Study of the Hand Operating Thresholds during the Usage of an Electric Steam Iron by College Students

Ya-Chuan Ko

Department of Creative Product Design, Asia University, Taichung, TAIWAN, ROC
Department of Medical Research, China Medical University Hospital, China Medical University, Taichung, TAIWAN, ROC

Received 16 February 2017 • Revised 25 May 2017 • Accepted 23 July 2017

ABSTRACT

Among various types of home appliances, an electric steam iron has a higher risk since it needs to operate under a condition with a higher range of temperature. In this study, a group of college students were invited to operate an electric iron during the experiment in order to investigate the correlation between an operator's hand and the possible contact with the iron soleplate during usage. The purpose of this study was to determine the hand portions which could easily get burned and the portions of the iron soleplate which tend to cause injuries. The results of this study indicated that the hand portions which could easily touch the soleplate are the right-hand side of the thumb and the forefinger. On the other hand, the portions on the soleplate which tend to cause burns are on the left-hand side of the iron, especially the sharper and upper half. The results serve as a good reference for follow-up designers on an iron design based on the safety consideration.

Keywords: ergonomics, operating threshold, product security, usability engineering

INTRODUCTION

During the activities and tasks of daily living, it seems to be unavoidable for people to carelessly get hurt due to their negligence. The purpose of ergonomics is to investigate the capability, behavior, limitation, and demands of humans so that these types of information could be utilized to create designs that are suitable for human usage. It can further reduce the probability of incidents and enhance the work efficiency at the same time. Among various types of home appliances, some of them usually operate at a higher range of temperature and these include a water boiler, oven, electric heater, steam iron, etc. Among them, an iron needs to operate at higher temperature and it has a higher risk level. When a person is operating an iron, his/her hands are in direct contact with it and therefore the injuries during iron operation typically occur on hands. Due to different functional requirements, different portions of hand skin have different degrees of pain tolerance such as the difference between the palm and the back of hand. The portion of an iron that could easily cause injuries is on its soleplate. Due to this consideration, the main objective of this study is to investigate the conditions of the contact between hand and iron soleplate during iron usage. It is expected to verify the hand portions that could easily get burned and the soleplate portions that could easily cause injuries. The results serve as a good reference for designers in the future when carrying out iron designs based on the safety consideration.

© **Authors.** Terms and conditions of Creative Commons Attribution 4.0 International (CC BY 4.0) apply.

Correspondence: Ya-Chuan Ko. Address 1: Assistant Professor, Department of Creative Product Design, Asia University, Taichung, TAIWAN, ROC. Address 2: Department of Medical Research, China Medical University Hospital, China Medical University, Taichung, TAIWAN, ROC.

✉ kyc.chris@msa.hinet.net & chrisko@asia.edu.tw

State of the literature

- Via the configuration of a typical task, the discount usability engineering approach can be used to determine the problems of individual usability. This approach can satisfy professional user for their problems and demonstrate a user's real tasks from the effectiveness in ecology by recommending functional developments and the description of characteristics.
- A simple approach was proposed for carrying out the usability evaluation model. It was used to determine the range of evaluating the interface of home appliances and to measure the usability.
- The theories of space allocation were applied to the measurement of human hands so that the optimal layout for operation can be obtained.

Contribution of this paper to the literature

- An approach for assessing the operating efficiency of an interface is proposed.
- The comfortable and accessible areas of an interface can be obtained by this approach based on palm dimensions.

LITERATURE REVIEW

Ergonomics

The term *ergonomics* came from the western world and it was usually called *human engineering* in the past. This term was often confused by people as a subject that studies humans or human bodies and thus was not favored by professionals and had been gradually declined. There was subsequently another term *human factors engineering* or simply *human factors*, which was generally called ergonomics. Its implication is to investigate the physical and psychological human factors that should be considered during an engineering design.

The definition of ergonomics by Sanders & McCormick (1993) is as follows. The objective of ergonomics is to discover and apply various types of knowledge in relation to human behaviors, capability, limitations, and other characteristics to the design of a tool, machine, system, operation, or working environment. The ultimate purpose is to make human usage more productive, safe, comfortable, and effective. More specifically, ergonomics is to pursue two main goals as follows. The first goal is to carry out ergonomic designs for human usage. The second goal is to apply ergonomics in pursuit of the optimization of working and living conditions.

Ergonomics is a subject that integrates several other subjects. Its fundamental research scope generally includes several topics as follows.

1. Human body measurement data: The measurement data of various features of a human body. This includes dimensions of various portions of a human body, range of movements, and other measures that are relevant to physical and psychological capabilities.
2. Human characteristics: This topic includes feelings such as vision, hearing, smell, etc., information input/output, human fitness activities such as physical functions, workload, biomechanics, muscular strength, endurance, etc.
3. Human-machine interface design problems: This topic include display devices, control device design, hand tool design, working space and layout, and manual material handling.
4. Environmental factors: This topic includes the description and investigation of physical factors such as workplace lighting, daylighting, noise, temperature and humidity conditions, and vibration.

The emphases of the discussions in this study include the movement range of hands during operation, product component layout, and injuries during usage.

USABILITY ENGINEERING

Since the usability engineering concept was first proposed in 1990s, it has been widely discussed and applied to various aspects such as interface, product, and system designs. Nielsen (1993) proposed that usability

testing is a technique used to evaluate a product by testing it with representative users. In the test, the users will try to complete typical tasks while observers watch, listen and takes notes. Heuristic-based design and evaluation are rules of thumb based on design principles. They can be used to guide the design of a usable GI product or to help assess or evaluate a working prototype.

According to the definition in the DIS 9241-11 standard by International Standards Organization (ISO), usability deals with the goal, efficiency, and degree of satisfaction that a user can achieve under a specific environment. It states that to determine usability, user performance and satisfaction must be measured. Usability measures are important, considering the complexity of interactions among the user, the task characteristics, and other elements within the context of use. A product can have significantly different levels of usability when used in different contexts. The standard also states that measures of user performance and satisfaction can provide a basis for comparing the relative usability of products having different technical characteristics used in the same context (ISO 9241, part 11, 1998).

Bevan et al. (1991) proposed that usability exists within the interactions between a user and products and systems. Moreover, usability can be measured by the performance, degree of satisfaction, and degree of acceptance. For a product, usability is a user's point of view toward the product's quality. Therefore, when there is any change in a product, system, user, work, or environment, the usability is affected. From the design point of view, the features of usability engineering are related to efficiency, performance, safety, comfort, and degree of satisfaction. The factors to be considered include "Who the user is?", "What the task is?", and "Under what environment is it used?" These factors frame the entire usability engineering. Nielsen (1993) proposed that usability is to describe the quality of a product or a system and it is more objective and equitable. He also proposed that usability evaluation of a system or a user interface is not of single dimension but is composed of five indices as follows.

1. Learn ability: The degree of easiness for a user to learn and use an interface or system.
2. Efficiency of use: The effectiveness for a user to use an interface or system effectively so as to ensure the usage efficiency of an interface or system can be enhanced.
3. Memorability: The degree of easiness for a user to memorize the way of using an interface or a system without forgetting how to use it after a while without using it.
4. Few and no catastrophic errors: The lower error rate for an interface or system so that the usage of an interface or system won't be affected by a user's wrong way of using it.
5. Subjective satisfaction: The higher degree of subjective satisfaction when a user is using an interface or system so that a product's degree of usage is enhanced.

Meanwhile, Nielsen also proposed four stages for the procedure of implementing the discount usability engineering into product design processes. These four stages for the evaluation procedure are as follows.

1. Develop appropriate scenarios,
2. Select appropriate tasks,
3. Perform user/work observations,
4. Conduct a heuristic evaluation.

The contents include the observation of a user's subjective responses, objective responses, and the way of using a product so as to find any problem and propose recommendations. The discount usability engineering approach can be used to determine the individual usage problems via the configuration of typical tasks. It can satisfy professional user problems and effectively present a user's real task from the ecological point of view so as to recommend functional developments and characteristic descriptions.

Besides, usability tests represent an important and widely used tool in product development (Jordan, 1998). Their aim is to identify design shortcomings throughout the product development process by evaluating the product or a prototype of it with prospective or real users and realistic tasks (Gould and Lewis, 1985). Typical measures collected in usability tests are effectiveness (extent to which typical user tasks are successfully completed) and efficiency of task completion (amount of resources that have to be spent to reach a task goal) as well as the

satisfaction a user experiences by using the product. Newer approaches in usability evaluation have enlarged the concept of usability and consider the whole user experience in product evaluation (Marcus, 2003; Norman, 2004). Sonderegger and Sauer (2013) proposed five typical user tasks in the context of coffee machine usage, measuring performance, perceived usability, and emotion.

The studies by Kwahk & Han (2002), Lee et al. (2006), Lee et al. (2006), Heo et al. (2009), Jin & Ji (2010) also proposed quantitative approaches for carrying out the principles of usability evaluation respectively. They also recommended introducing the usability risk level evaluation during the earlier stage of conceptual designs since a design at the earlier stage will affect the usability interface. From the aspect of product designs, Chou (2016), Hsiao et al. (2017), and Ko et al. (2017) proposed decomposing and analyzing a product by perceptions and practical operations in order to determine the optimal solution.

Hand Structure

The external form of a hand can be classified into four portions which include wrist, palm, back of hand, and fingers. Each hand has five fingers, which are respectively the thumb, forefinger, middle finger, ring finger, and pinky finger. A finger is consisted of portions such as the finger pulp, fingertip, and the nail. The thumb side where the upper arm radius is located is called the radial side or the outer side. The pinky finger side where the upper arm ulna is located is called the ulnar side or the inner side. The wrist connects the forearm to the wrist. The inner side of the portion where the wrist connects to fingers is called palm and the outer side is called the back of hand. The central recess of the palm is called the center of the palm. The muscles on the radial side and the ulnar side are more developed and they present a bulge in the shape of a fish belly. These muscles are called thenar muscle and hypothenar muscle respectively.

Due to different functional requirements on the hand skin, there are differences between the skin on the palm and that on the back of hand. The skins on the palm and the finger sides are rougher with a thicker stratum corneum. There is a thicker fat pad within the subcutaneous so that the skin is not damaged when in touch with any rough items. There are vertical fiber intervals under the hand skin so that the skin connects to deeper tissues such as finger bones and epitenon. This structure avoids much sliding of the skin and therefore the elasticity of the palm-side skin is lower. On the contrary, the skins on the back of hand and finger back are thin, soft, and elastic. The hypoderm is loose with a larger degree of sliding.

The emphasis of this study is on the contact area between hands and an iron along with the corresponding risks of getting burned when operating an iron.

Average Skin Temperature and Feeling Hot or Cold

According to the *Development of Workplace Hazard Evaluation in Extreme Temperature* published by Institute of Labor, Occupational Safety and Health, Ministry of Labor, Ministry of Labor, Executive Yuan, Taiwan, in 2008, when the skin is exposed to a temperature that is higher than 45°C, the tissues get damaged quickly. Since an iron remains at a temperature higher than 45°C during the ironing process, the user can get injured easily if he/she touch the iron soleplate carelessly. The average temperature and the corresponding feeling of hot or cold can be summarized into **Table 1** according to the study by Gagge & Nishi (1977).

EXPERIMENTAL APPROACH

College students were selected as the research subjects in this study. This is due to the fact that there are currently about 100,000 college students in Taiwan and approximately 50,000 of them are renting private accommodations outside the school. Therefore, there is a great chance for them to use personal home appliances and college students were selected for the investigation. Among various types of home appliances, irons are among the most frequently used home appliances for college students. Therefore, the case study was carried out on irons for further investigation.

Table 1. Average skin temperature and the corresponding feeling of hot or cold

Average skin temperature (°C)	Skin feeling
45	Fast injury of tissues
41~43	Threshold of burning pain
39~41	Threshold of instant pain
35~39	Feeling hot on the skin
35~37	Beginning of warm or hot feeling
33~34	Feeling of moderate temperature and comfortable during rest
32~33	Feeling of moderate temperature when the metabolism rate is 2~4 MET
30~32	Feeling of moderate temperature when the metabolism rate is 3~6 MET
30~36	Skin temperature is roughly equal to the operating temperature ($t_{sk} \approx t_o$) and is not related to metabolic heat
29~31	Feeling uncomfortable and cold without any activity
25 (Local)	Feeling numb on the skin
20 (Hand)	Uncomfortable and cold
15 (Hand)	Very uncomfortable and cold
5 (Hand)	Cold and cannot bear the pain anymore (may lose skin sensation)

Table 2. Fundamental process of operating an iron

Step #	Operating behavior	Relevant component
Step 1	Shut off the steam	Thermostat
Step 2	Fill water in	Fill opening
Step 3	Set temperature/ material	Status button
Step 4	Lift the iron up	Handle/Lift support
Step 5	Plug in	Power plug
Step 6	Wait while temperature is increasing	Status indicator
Step 7	Ironing	Handle/ steam soleplate /steam button
Step 8	Wait while the iron cools	Status indicator
Step 9	Release water	Water outlet port

Table 3. Descriptions of ironing steps

Step Number	Operation action
Step 1	Ironing collars Put the iron down and lift it up
Step 2	Ironing sleeves Put the iron down and lift it up
Step 3	Ironing around buttons

The experiments in this study were carried out in three portions as follows.

1. Analysis of the procedures of operating an iron
2. Measurement of subjects' palm sizes for a group of college students
3. Practical operations of experiments by a group of college student

Analysis of The Procedures of Operating an Iron

The first step is to analyze the procedures of operating an iron. The complete process of the typical way of operating an iron is summarized in **Table 2** as follows. Among these steps, the ironing process in Step 7 is most likely to cause injuries since the user might easily and accidentally touch the soleplate. Based on this, we focused on this ironing process and further classified this process into ironing different portions of clothes including ironing the collars, ironing the sleeves, and ironing around the buttons. During each of the steps, we asked the subjects to put the iron down and lift it up again as described in **Table 3**.

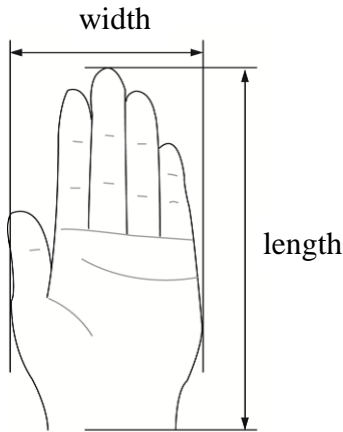

Figure 1. Dimensions of a left palm for measurement

Table 4. Summary of the data of all subjects

Subject #	Gender	Age	Frequency-of-use (Month/once)	Palm length (cm)	Palm width (cm)
1	Female	24	6	9	16.5
2	Female	25	12	9	17
3	Male	25	1	10.5	18.5
4	Male	24	12	11.5	19
5	Female	32	6	8.5	17.1
6	Female	23	1	8.8	17.9
7	Female	25	12	8.3	17.2
8	Female	23	3	9.4	19.5

Data of Subjects and Measurements of Their Palm Sizes

There are total of 8 subjects in this experiment. Among them, there are 2 males and 8 females and they are in the age of 23~32 years old. All of them have the experience of using an iron. During the process of using an iron, a user usually grasps the iron by his/her right hand which is less likely to touch the iron’s soleplate. Therefore, the experiment in this study stressed at the investigation on their left hands. At the beginning of the experiment, we measured the size of each subject’s left palm in the way as shown in **Figure 1**. A summary of the detailed data of the subjects are as shown in **Table 4**.

Practical Operations of Experiments by The Subjects

The main purpose of this experiment is to understand the condition of the contact between a user’s hand and the iron soleplate when he/she is using an iron. Via this experiment, we can understand which portion on the hand can easily get burned and the portion which tends to be in contact with the iron soleplate. The iron model for experiment is an elongated steam iron EUPA TSK-711LC. This model was selected for experiments since it is easy-to-use, inexpensive, and practical for a college student to use in his/her renting accommodation when studying in a place other than his/her home. In order to reduce the number of research variables during the experiments, the same test specimen was used in this study.

The experiment was carried out in a way that each of the subjects was asked to go through the ironing steps including ironing collars, ironing sleeves, and ironing around buttons as shown in **Table 3**. We also observed the subjects’ operating behaviors so as to analyze and conclude the condition of the contact between a subject’s



Figure 2. The first camcorder to record the experiment from the front



Figure 3. The first camcorder to record the experiment from the left



Figure 4. The first camcorder to record the experiment from the right

hand and the iron soleplate when he/she was performing the steps with the iron. To prevent the subjects from really getting burned, they carried out the experiment by keeping the iron unplugged. However, to ensure no loss during the observation of this experiment, we used three camcorders to record the experiment from the front, left, and right of each subject as shown in **Figures 2~4**. This allows us to repeatedly observe and analyze the operation conditions of each subject.

EXPERIMENTAL RESULTS AND ANALYSIS

We observed the ironing operation process of each subject and carried out analysis and investigation on the portion of each subject's left hand in contact with the iron soleplate and the relevant distances. The observation results of these eight subjects are summarized into figures, in which different colors indicate different contact distances and risk levels. Risk Level 1 is in red and it indicates the distance between hand and soleplate is in the range of 0~1 cm. Risk Level 2 is in orange and it indicates the distance between hand and soleplate is in the range of 1~2 cm. Risk Level 3 is in yellow and it indicates the distance between hand and soleplate is in the range of 2~3 cm. Risk Level 4 is in green and it indicates the distance between hand and soleplate is in the range of 3~4 cm. These risk levels are summarized in **Table 5**. After all of experiments finished, the contact condition between each subject's hand and iron soleplate is summarized in **Figures 5~12**.

Table 5. Assessment table of the contact between a subject's hand and the iron soleplate

Range of distance (in cm)	0-1	1-2	2-3	3-4
Risk level	1	2	3	4
Level color				

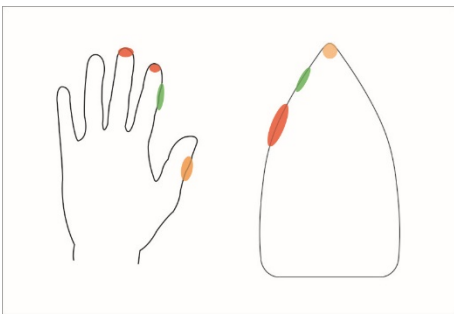

Figure 5. Portions of contact between Subject #1's hand and the iron soleplate

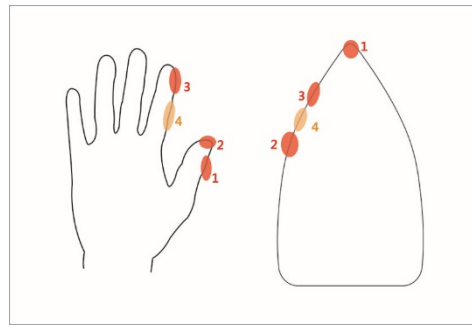

Figure 6. Portions of contact between Subject #2's hand and the iron soleplate

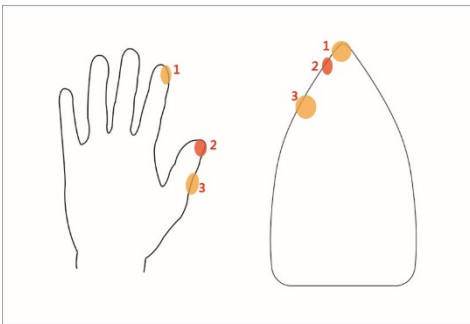

Figure 7. Portions of contact between Subject #3's hand and the iron soleplate

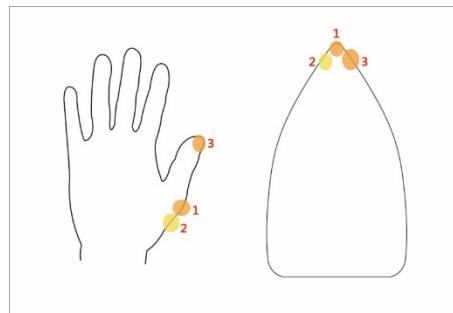

Figure 8. Portions of contact between Subject #4's hand and the iron soleplate

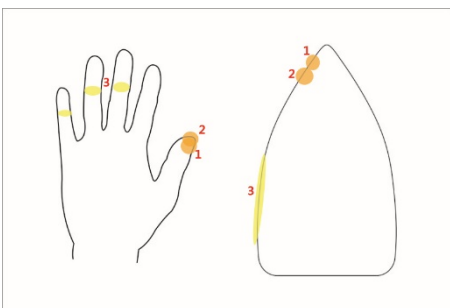

Figure 9. Portions of contact between Subject #5's hand and the iron soleplate

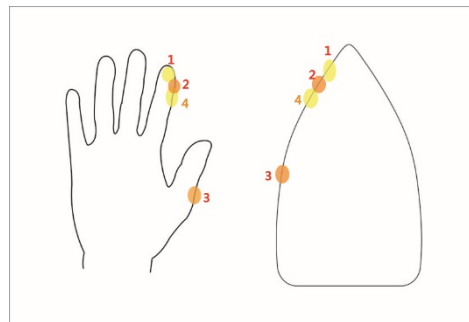

Figure 10. Portions of contact between Subject #6's hand and the iron soleplate

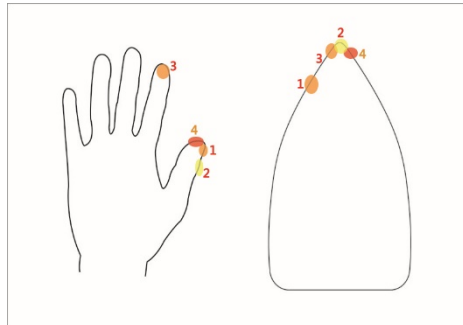

Figure 11. Portions of contact between Subject #7's hand and the iron soleplate

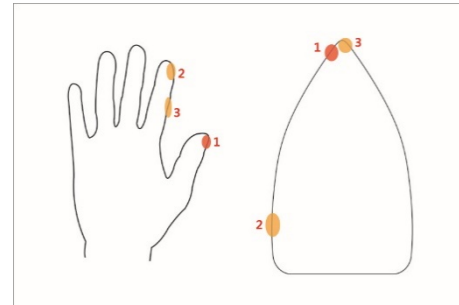

Figure 12. Portions of contact between Subject #8's hand and the iron soleplate

The conditions of the contact between the hands and the iron soleplate for each research subject were recorded and reviewed. The hand portions that tend to touch the iron soleplate during the ironing process for all of the subjects are summarized in **Figure 13**, in which a darker color indicates a higher frequency of contact with the iron soleplate. On the other hand, the portions of the iron soleplate that can easily get in touch with the iron soleplate are shown in **Figure 14**, in which a darker color indicates a higher frequency of contact.



Figure 13. Probability distribution for contacts with the iron soleplate on the hand

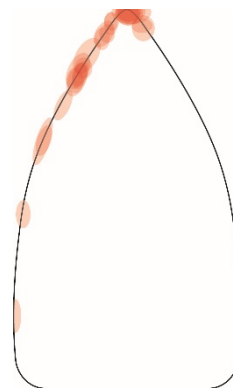

Figure 14. Probability distribution for contacts with the hand on the iron soleplate

CONCLUSIONS AND SUGGESTION

The results of the experiments indicated that the portions on the subjects' hands with the highest probability of contact with the iron soleplate are the right-hand sides of the thumb and the forefinger. The portions on the iron soleplate with the highest probability of contact with the hand are mainly on the left-hand side and especially the upper-left tip portion. Therefore, any follow-up research on the safety considerations for an iron design is advised to aim at these two portions for improvement or further protective measures so as to enhance the safety of an iron and reduce the probability for a user to get burned during operations.

For follow-up studies, it is recommended to carry out the analysis of the modification of interface layouts for typical tasks of operations in order to determine the optimal solution to the interface layout of an iron. No further research was carried out in this study on the iron's own material. Using a lightweight material for an iron can reduce the burden on a user's muscles. Therefore, the burden on muscles and the lightweight consideration should serve as the development emphasis for follow-up studies.

REFERENCES

- Bevan, N., Kirakowski, J., & Maissel, J. (1991). What is usability?. *Proceedings of the 4th International Conference on HCI*, 165-169.
- Chen, C. J., & Dai, Y. T. (2008). Development of Workplace Hazard Evaluation in Extreme Temperature. *Institute of Labor, Occupational Safety and Health, Ministry of Labor, Ministry of Labor, Executive Yuan, Taiwan*.
- Chou, J. R., (2016). An Empirical Study of User Experience on Touch Mice. *Eurasia Journal of Mathematics, Science & Technology Education*, 2016, 12(11), 2875-2885.
- Fernström, E., & Ericson, M. O. (1997). Computer Mouse or Trackpoint - Effects on Muscular Load and Operator Experience. *Applied Ergonomics*, 28, 347-354.
- Gould, J. D., & Lewis, C. (1985). Designing for usability: key principles and what designers think. *Communications of the ACM*, 28(3), 300-311.
- Gustafsson, E., & Hagberg, M. (2003). Computer Mouse Use in Two Different Hand Positions: Exposure, Comfort, Exertion and Productivity. *Applied Ergonomics*, 34, 107-113.
- Heo, J., Ham, D. H., Park, S., Song, C., & Yoon, W. C. (2009). A framework for evaluating the usability of mobile phones based on multi-level, hierarchical model of usability factors. *Interact. Comput.*, 21, 263-275.
- Herring, S. R., Castillejos, P. M., & Hallbeck, M.S. (2011). User-centered Evaluation of Handle Shape and size and Input Controls for a Neutron Detector. *Applied Ergonomics*, 42, 919-928.
- Hsiao, S. W., & Lin, H. H., & Ko, Y.C., (2017). Application of Grey Relational Analysis to Decision-Making during Product Development. *EURASIA Journal of Mathematics Science and Technology Education*, 13(6), 2581-2600.
- ISO 9241-11. (1998). *Ergonomic Requirements for Office Work with Visual Display Terminals (VDTs), Part 11: Guidance on Usability*.
- Jin, B. S., & Ji, Y. G. (2010). Usability risk level evaluation for physical user interface of mobile phone. *Comput. Ind.*, 61, 350-363.
- Jindrich, D. L., Balakrishnan, A. D., & Dennerlein, J. T. (2004). Effects of Keyswitch Design and Finger Posture on Finger Joint Kinematics and Dynamics during Tapping on Computer Keyswitches. *Clin. Biomech.*, 19, 600-608.
- Johnson, P. W., Hagberg, M., Hjelm, E. W., & Rempel, D. (2000). Measuring and Characterizing Force Exposures during Computer Mouse Use. *Scand. J. Work. Environ. Health*, 26, 398-405.
- Jordan, P. W. (1998). Human factors for pleasure in product use. *Applied Ergonomics*, 29, 25-33.
- Ko, Y.C., & Lo, C. H., & Hsiao, S. W., (2017). Interface Design Optimization by an Improved Operating Model for College Students. *EURASIA Journal of Mathematics Science and Technology Education*, 13(6), 2601-2625.
- Kwahk, J., & Han, S. H. (2002). A methodology for evaluating the usability of audiovisual consumer electronic products. *Applied Ergonomics*, 33, 419-431.
- Lee, D. L., McLoone, H., & Dennerlein, J. T. (2008). Observed Finger Behaviour during Computer Mouse Use. *Applied Ergonomics*, 39 107-113.
- Lee, S., Heo, G., & Chang, S. H. (2006). Prediction of the human response time with the similarity and quantity of information. *Reliab. Eng. Syst. Safe*, 91, 728-734.
- Lee, Y. S., Hong, S. W., Smith-Jackson, T. L., Nussbaum, M. A., & Tomioka K. (2006). Systematic evaluation methodology for cell phone user interfaces. *Interact. Comput.*, 18, 304-325.
- Liu, R. Q. (2006). *Cure a Patient by Mere Touch - Hand Health Therapy*. Sea Wave Publishing House.
- Marcus, A. (2003). The emotion commotion. *Interactions*, 10, 28-34.
- Nielsen, J. (1993). *Usability Engineering*, Academic Press, Boston.
- Norman, D. A. (2004). *Emotional Design: Why We Love (or Hate) Everyday Things*. New York: Basic Books.
- Sanders, M. S., & McCormick, E. J. (1993). *Human Factors in Engineering and Design*. McGraw-Hall.
- Smith, A., & Dunckley, L. (2002). Prototype Evaluation and Redesign: Structuring the Design Space Through Contextual Techniques. *Interact. Comput.*, 14, 821-843.

- Sutter, C., & Ziefle, M. (2004). Psychomotor Efficiency in Users of Notebook Input Devices: Confirmation and Restrictions of Fitts' Law as an Evaluative Tool for User-Friendly Design. In: Human Factors and Ergonomics Society Annual Meeting Proceedings. *Computer Systems*, 5, 773-777.
- Sutter, C., & Ziefle, M. (2006). Psychomotor Performance of Input Device Users and Optimized Cursor Control. In: Human Factors and Ergonomics Society Annual Meeting Proceedings. *Computer Systems*, 5, 742-746.
- Tilley, A. R. (1993). *The Measure of Man and Woman: Human Factors in Design*. Henry Dreyfuss Associates.
- Wang, C. I. (2008). Construction and Evaluation on Tool Handle for Taiwanese, Master's thesis, Graduate Institute of Industry, National Yunlin University of Science and Technology.
- Wang, E. M. Y., & Chao, W. C. (2010). In Searching for Constant Body Ratio Benchmarks. *Int. J. Ind. Ergonom.*, 40, 59-67.
- Woods, V., Hastings, S., Buckle, P., & Haslam, R. (2003). Development of Non-Keyboard Input Device Checklists through Assessments. *Applied Ergonomics*, 34, 511-519.

<http://www.ejmste.com>



<http://www.ejmste.com>



<https://twitter.com/ejmste>



<https://www.facebook.com/ejmste>



<http://modestum.co.uk/>



publications@modestum.co.uk



OPEN ACCESS

EURASIA Journal of Mathematics Science and Technology Education
ISSN: 1305-8223 (online) 1305-8215 (print)
2017 13(9):6337-6346
DOI: 10.12973/eurasia.2017.01068a



Research on College Students' Entrepreneurial Team Heterogeneity under the Background of Entrepreneurship Education

Yonghui Cao

Henan University of Economics and Law, CHINA
Henan Institute of Science and Technology, CHINA
China Institute for Reform and Development, CHINA

He Jiang

Zhejiang University, CHINA

Received 20 March 2017 • Revised 9 August 2017 • Accepted 4 September 2017

ABSTRACT

Entrepreneurial teams play a crucial role in the success of entrepreneurship. But how does the heterogeneity of entrepreneurial teams affect entrepreneurial team decision-making? The role of team communication in the middle has not yet been explored deeply. This paper takes the entrepreneurial team of college students in China as the research object, and empirically explores the relationship among Entrepreneurial Team Heterogeneity, Team Communication, and Entrepreneurial Decision-making. This paper finds: (1) Entrepreneurial team heterogeneity (internal and external heterogeneity) positively influences entrepreneurial decision-making; (2) Entrepreneurial team communication positively influences entrepreneurial decision-making; (3) Entrepreneurial team communication plays an intermediary role in entrepreneurial team heterogeneity (internal and external heterogeneity) and entrepreneurial decision-making process. At the same time, the conclusions of this study have brought us useful practical inspiration: Although all members of the entrepreneurial team had certain differences in gender, age, education and other aspects, and their views on the same issue also had certain differences, the team members were closely related to each other as a whole. In order to enhance mutual understanding of the team members and to promote consensus among them, team members must often communicate. Frequent and effective team communication develops entrepreneurial decision-making. Therefore, members of the entrepreneurial team should communicate in a variety of ways to guide them adequately and effectively.

Keywords: entrepreneurial team heterogeneity, team communication, entrepreneurial decision-making

INTRODUCTION

In the competition environment and Internet economy, "entrepreneurship" has been unable to adapt to new challenges and demands. "Team entrepreneurship" gradually replaced the "individual entrepreneurship" and has

© **Authors.** Terms and conditions of Creative Commons Attribution 4.0 International (CC BY 4.0) apply.

Correspondence: He Jiang, *Doctor, School of Management, Zhejiang University, Hangzhou, 310058, China* & Yonghui Cao, *Doctor, School of E-commerce and Logistics Management, Henan University of Economics and Law, Zhengzhou, 450046, China; School of Economics & Management, Henan Institute of Science and Technology, Xinxiang, 453003, China; China Institute for Reform and Development, Haikou, 570312, China.*

✉ lurky2000@126.com & caoyonghui2000@126.com

State of the literature

- China has preferential policies and encouragement for college students to start their own businesses. However, the research on the entrepreneurial team, especially about the relationship between entrepreneurial team heterogeneity and entrepreneurial decision-making still lacks systematic theoretical and empirical analysis.
- Some existing studies have mainly analyzed the relationship between entrepreneurial team heterogeneity and entrepreneurial performance, but the conclusions are also quite different. Some scholars point out that entrepreneurial team heterogeneity forms complementary advantages, so that start-ups have more advantages in competition, and the performance is more obvious. However, there is also another point of view. Some scholars point out that this heterogeneity cannot directly be translated into the competitiveness of enterprises, and this heterogeneity needs to be realized by means of other conditions.
- How does the entrepreneurial team heterogeneity affect the decision-making of the entrepreneurial team, and how the team communication plays an important role in the middle, become problems that need to be solved urgently.

Contribution of this paper to the literature

- Entrepreneurial teams play a crucial role in the success of entrepreneurship. But how does the heterogeneity of entrepreneurial teams affect entrepreneurial team decision-making? The role of team communication in the middle has not yet been explored deeply. This paper takes the entrepreneurial team of college students in China as the research object, and empirically explores the relationship among Entrepreneurial Team Heterogeneity, Team Communication, and Entrepreneurial Decision-making.
- Although all members of the entrepreneurial team had certain differences in gender, age, education and other aspects, and their views on the same issue also had certain differences, team members were closely related to each other as a whole. In order to enhance mutual understanding of the team members and to promote consensus among them, team members must often communicate. Frequent and effective team communication develops entrepreneurial decision-making.

become the mainstream. The research of related scholars also shows that team entrepreneurship has higher success rate and better entrepreneurial performance than individual entrepreneurship (Francis & Sanberg, 2000; Hormiga, Hancock & Jaría, 2017; Cao & Jiang, 2017). Some scholars point out that the entrepreneurial team in the start-up stage is critical to the success of many of the existing excellent enterprises, and the formation of the entrepreneurial team is not just a simple process of personnel stacking (Keerativutisest, & Hanson, 2016; Dufays & Huybrechts, 2017). Ensley & Hmieleski further emphasize whether it can guarantee strong cohesion and better stability among the members of the entrepreneurial team, which is the key to the success of the business (Ensley & Hmieleski, 2005).

Entrepreneurial team is a special team composed of many different individuals, and the diversity of team members may influence strategic decisions of the entrepreneurial team in varying degrees (Khan, 2017; Forsström-Tuominen, Jussila & Goel, 2017). At present, China has preferential policies and encouragement for college students to start their own businesses (Jiang, Xiong & Cao, 2017). However, the research on the entrepreneurial team, especially about the relationship between entrepreneurial team heterogeneity and entrepreneurial decision-making still lacks systematic theoretical and empirical analysis. Some existing studies have mainly analyzed the relationship between entrepreneurial team heterogeneity and entrepreneurial performance, but the conclusions are also quite different. Timmons has investigated several companies and found that the advantages of team entrepreneurship are more prominent. The reason is that different backgrounds, experiences and skills of team members make human capital show heterogeneity. This heterogeneity also forms complementary advantages, so that start-ups have more advantages in competition, and the performance is more obvious. However, there is also another point of view. Pelled believes that this heterogeneity cannot directly be translated into the competitiveness of enterprises, and this heterogeneity needs to be realized by means of other conditions (Pelled, 1996). This implementation mechanism is still a "black box". If we fail to reveal the specific content of the "black box", we may conclude that heterogeneity leads to misunderstanding and conflict among team members, and ultimately reduces entrepreneurial performance. In addition, the entrepreneurship education of college students' entrepreneurial team also challenges the future development and education of university teachers (Cao, Kurbanova & Salikhova, 2017).

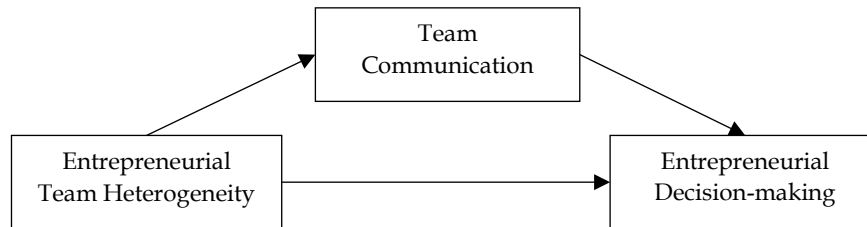

Figure 1. Framework diagram of this study

With the increase of college students' entrepreneurial teams, graduate students have joined the entrepreneurial team (Cao, Kirilova & Grunis, 2017). This research is of great significance for the effective development of college students' entrepreneurship education in China.

Therefore, how does the entrepreneurial team heterogeneity affect decision-making of the entrepreneurial team, and how the team communication plays an important role in the middle, become problems that need to be solved urgently. The author tries to answer these questions in an empirical way. In fact, the effective answers to this series of questions can provide not only a reference for college students with entrepreneurial intention, but also helps the entrepreneurs who have already started their practice and want to improve the efficiency of team entrepreneurship. Based on this, this paper studies the relationship between entrepreneurial team heterogeneity, team communication, and team decision, and to clarify its mechanism, promote the theory of entrepreneurship education. The specific research framework is shown in **Figure 1**.

THEORETICAL BASIS AND RESEARCH HYPOTHESIS

Entrepreneurial Team Heterogeneity and Entrepreneurial Decision-Making

Team heterogeneity generally refers to the difference between the team members' demographic characteristics and important concepts, values and other aspects of their experience (Dufays & Huybrechts, 2016). For entrepreneurial teams, specific attributes such as gender, age, race, education, and entrepreneurial experience are easily observed. Attributes such as cognition, values, preferences, attitudes, and entrepreneurial commitment are not easily observed. Because of the rich connotation of team heterogeneity, scholars have classified the heterogeneity of teams from different perspectives to facilitate research, such as social category heterogeneity, information heterogeneity, and value heterogeneity. Pelled divides team heterogeneity into low work related (gender, age) and high work related heterogeneity (such as education level, tenure, etc.) according to the relationship between individual characteristics and team tasks. Hambrick et al. suggest relational orientation heterogeneity (Relations-Related), including gender, age, ethnicity, etc. within the team members (Hambrick, Cho & Chen, 1996). Ensley et al. propose task oriented heterogeneity (Task-Related) based on work related perspectives, including cultural values, knowledge and skills, hours of work, etc. (Ensley, Carland, & Carland, 1998). Summarizing relevant literature, Jehn et al. argue that age heterogeneity, educational background heterogeneity, functional background heterogeneity (empirical heterogeneity) and value heterogeneity can cover these two levels (Jehn, Northcraft & Neale, 1999).

The research shows that heterogeneous teams are more likely to generate new ideas and concepts and promote team innovation because they have different perspectives and have more knowledge. Many studies have verified this relationship. Eisenhardt and Schoonhoven suggest that entrepreneurial teams with greater skill differentiation can better influence performance of new ventures than teams with similar skills (Eisenhardt & Schoonhoven, 1990). Some scholars point out that heterogeneous teams can provide more technical knowledge and information combination for new ventures. This leads to the improvement of entrepreneurial performance. Cultural differences among team members contribute to innovative ideas of entrepreneurial teams. On the other hand, heterogeneity leads to increased team coordination costs and integration costs, while team members' differences

are also more likely to lead to conflicts, which can also hamper innovation. He analyzed the relationship between entrepreneurial team heterogeneity and entrepreneurial performance.

However, more studies have shown that differences in age and values among entrepreneurial teams create an open, comprehensive exchange and discussion environment that allows members to communicate more sparks and ideas. It also avoids the dependence and limited rationality of entrepreneurial decisions on individuals. The heterogeneity of education and function background can complement each other among team members. It also helps the team members to find their lack of ability, improve their learning awareness, enhance their learning ability, and create an atmosphere of organizational learning within the start-up enterprise. It also helps innovation and enhances performance.

Based on the above analysis, the following hypotheses are inferred:

- H1:** Entrepreneurial team heterogeneity has a significant positive effect on entrepreneurial decision-making.
- H1a:** The internal heterogeneity of entrepreneurial team has a significant positive effect on entrepreneurial decision-making.
- H1b:** The external heterogeneity of entrepreneurial team has a significant positive effect on entrepreneurial decision-making.

Team Communication and Entrepreneurial Decision-Making

Communication is critical to an entrepreneurial team. In the process of college students' entrepreneurship, any stage activities cannot be separated from the cooperation between team members, while good communication is the prerequisite to ensure cooperation. In the process of team strategic decision-making, team members evaluate each team's environment and resources, depending on its own knowledge, experience, and information. Since team members are different in knowledge, experience and acquired information, each member analyzes entrepreneurial strategy from a different perspective. If there is a lack of effective communication, team members would be unable to communicate adequately with entrepreneurial decisions. This may lead members to failure in reaching a consensus on the strategy of entrepreneurship, may further lead the whole team to not being well aware of the risks and opportunities faced in the process of entrepreneurship.

A great deal of research has been done to validate the relationship between team interaction and team innovation performance. Ancona points out that the relationship between the team as a whole and the external environment, and the quality of interaction among members of the team, is crucial for the team to accomplish its tasks successfully and achieve good results (Ancona, 1990). Therefore, controlling and managing the interaction process among members of the team plays a very important role in improving team performance. Tewart & Barrick point out that the most important factor influencing team performance is team process, and the core of team process is interaction behavior among team members (Stewart & Barrick, 2000). Lechler studied 159 entrepreneurial teams in the high-tech field. Through empirical research, it is pointed out that the dimensions of social interaction of team members have significant positive correlation with each index dimension of entrepreneurial performance (Lechler, 2001). As a result, in the process of entrepreneurial decision-making, good communication between team members will also allow team members to fully communicate their opinions. Discussing entrepreneurial decisions from various angles will help smooth the development of entrepreneurial decision-making process, improve the quality of decision-making, and enhance the recognition of decision-making.

The following assumptions are made.

- H2:** Entrepreneurial team communication has a significant positive effect on entrepreneurial decision-making.

The Mediating Role of Team Communication in Entrepreneurial Team Heterogeneity and Entrepreneurial Decision-making

Differences in team members' knowledge, skills, experience, and values increase the need for team members to communicate with each other. Hoffman & Maier pointed out in the research of top management teams that there are some differences among team members on their special level, which leads to some differences in their cognition of things (Hoffman & Maier, 1961). As a whole, these differences allow teams to obtain information gathered by their members from different sources and different views of team members on related issues. These enrich the knowledge-base of the team as a whole, and guide the members of the team to discuss the related issues actively and in depth, and analyze the opportunities, threats, advantages and disadvantages of the internal and external environment. Team communication emphasizes the exchange of information, feelings, and knowledge and experience among team members. It is an exchange of ideas, opinions, and facts. Environmental factors and structural factors will have a great influence on the smoothness and effectiveness of team communication (Gundry, Ofstein & Monllor, 2016). At the same time, members' personal factors will also affect the efficiency and quality of team communication to a great extent. In the process of team communication, different attitudes and opinions of different members will influence the effective communication among team members. In the process of making strategic decisions in an entrepreneurial team, frequent and smooth team communication will help team members communicate adequately about the risks faced by the team in the process of entrepreneurship. By integrating the opinions and insights of different team members, the team will be able to conduct a comprehensive analysis of its internal and external environment and make optimal strategic decisions (Hormiga Pérez, Hancock & Jaría Chacón, 2017).

The following assumptions are made.

- H3:** Entrepreneurial team communication plays an intermediary role between entrepreneurial team heterogeneity and entrepreneurial decision-making
- H3a:** Entrepreneurial team communication plays an intermediary role between entrepreneurial team internal heterogeneity and entrepreneurial decision-making
- H3b:** Entrepreneurial team communication plays an intermediary role between entrepreneurial team external heterogeneity and entrepreneurial decision-making

EVALUATED MEASUREMENTS

Data Collection

On the basis of literature study and interview, this paper designed the preliminary results. In order to check whether the item meaning is clear and accurate, the authors conducted a small-scale sample test. According to test results, the questionnaire was revised many times. This paper ultimately determines the measurement items of the questionnaire.

The author investigated through field questionnaires, e-mail questionnaires and so on. The subjects of the questionnaire are mainly college students, and entrepreneurial team members. The questionnaire used 5 subscales, of which 1 indicated complete non-consent; 2 indicated non-agreement; 3 indicated neutrality; 4 indicated agreement; 5 indicated complete agreement. The author sent 250 questionnaires to 50 universities and collected 223 copies, with a recovery rate of 89.2%. Among them, 183 were valid, and the effective rate was 82.06%.

Reliability and Validity

In this paper, SPSS data analysis software is used to test the reliability and validity of each variable measurement scale. In the empirical study, the internal consistency reliability is the most commonly used reliability test, while the Cronbach's alpha coefficient is the most commonly used measure in the internal consistency

Table 1. Results of reliability and validity (n=183)

Variable	Item	Cronbach's alpha	KMO	Bartlett sphere test Sig	Factor loading	
Entrepreneurial Team Heterogeneity	ETH1	0.790	0.806	0.000	0.463	0.746
	ETH2				0.481	0.746
	ETH3				0.503	0.741
	ETH4				0.437	0.561
	ETH5				0.782	-0.389
	ETH6				0.745	-0.524
	ETH7				0.799	-0.427
	ETH8				0.771	-0.372
Team Communication	TC1	0.830	0.795	0.000	0.707	
	TC2				0.715	
	TC3				0.796	
	TC4				0.787	
	TC5				0.849	
Entrepreneurial Decision	ED1	0.792	0.786	0.000	0.792	
	ED2				0.819	
	ED3				0.717	
	ED4				0.813	

reliability test. Generally speaking, if the Cronbach's alpha coefficient is greater than 0.7, then it is considered to be an ideal level of reliability.

In this study, the measurement scales of each variable are revised on the basis of drawing on the mature scale of scholars both at home and abroad. Therefore, it can be considered that the content validity of the variables used in this paper is acceptable. For the test of construct validity, the KMO value measure, Bartlett sphericity test and factor load are used to measure the construct validity. The KMO value is used to determine the correlation between the items in the scale. The main purpose of the Bartlett sphericity test is to analyze whether or not there is a high degree of correlation between scale items. In general, the KMO value should be greater than 0.7, while the Bartlett sphericity test should be below the significant level of 0.01 or 0.05. At the same time, the factor load value of each item usually requires more than 0.5.

In this study, the reliability and validity of the questionnaire were tested by using SPSS data analysis software, and the results are shown in **Table 1**. The Cronbach's alpha values of all variables in this study were above 0.7. It shows that the questionnaire has good reliability. The KMO values are all above 0.7, and the results of Bartlett sphericity test are all lower than 0.01. The factor loadings of each item in their corresponding common factors are all greater than 0.5, which means that the questionnaire also has good construct validity. Among them, the "ETH1" to "ETH4" items were extracted out of a factor, named "Entrepreneurial Team External Heterogeneity", "ETH5" to "ETH8" titles were extracted out of another factor, named "Entrepreneurial Team Internal Heterogeneity".

Descriptive Statistical Analysis of Variables

First, the mean and standard deviations of each variable are calculated. Then, the correlation between the variables is analyzed. The results are shown in **Table 2**. Among them, entrepreneurial team internal heterogeneity and team communication ($r = 0.24, P < 0.01$), entrepreneurial decision-making ($r = 0.21, P < 0.01$) showed a significant positive correlation. At the same time, entrepreneurial team external heterogeneity and team communication ($r = 0.30, P < 0.01$), entrepreneurial decision-making ($r = 0.20, P < 0.01$) showed significant positive correlation. There was a positive correlation between team communication and entrepreneurial decision-making ($r = 0.26, P < 0.01$). Additionally, the entrepreneurial team external heterogeneity and age ($r = 0.10$), gender ($r = 0.12$)

Table 2. The mean, variance and correlation of the major variables (n=183)

Variable	Mean	Standard deviation	1	2	3	4	5	6	7	8
1. Age	27.77	16.29	1.00							
2. Gender	0.38	0.49	0.11	1.00						
3. Major	2.02	0.78	0.02	0.07	1.00					
4. Degree	1.99	0.79	0.06	0.00	0.01	1.00				
5. Internal heterogeneity	3.41	0.71	0.01	0.06	0.10	0.11	1.00			
6. External heterogeneity	3.50	0.68	0.10	0.12	0.09	0.05	0.09	1.00		
7. Team communication	3.35	0.63	0.06	0.04	0.05	0.08	0.24**	0.30**	1.00	
8. Entrepreneurial decision-making	3.27	0.68	0.04	0.08	0.05	0.12	0.21**	0.20**	0.26**	1.00

Note: n = 183; ** p < 0.01 * p < 0.05

Sex: (0) Male, (1) female;

Major: (1) science, (2) Engineering, (3) Humanities and Social Sciences

Education: (1) Master's degree or above, (2) Undergraduate, (3) Junior and below

Table 3. Hypothesis test results (n=183)

Control variable	Team communication			Entrepreneurial decision-making			
	Model 1	Model 2	Model 3	Model 4	Model 5	Model 6	Model 7
Age	0.07	0.05	0.06	0.04	0.04	0.02	0.01
Gender	0.06	0.01	0.06	0.07	0.08	0.06	0.06
Major	0.05	0.06	0.05	0.04	0.04	0.06	0.05
Degree	0.08	0.01	0.08	0.11	0.12	0.13	0.13
Independent variable							
Internal heterogeneity		0.33**			0.20**		0.15*
External heterogeneity			0.24**			0.21**	0.18*
Mediator variable							
Team communication							0.17*
ΔR2	0.02	0.53	0.22	0.17	0.02	0.04	0.01
ΔF	0.69	6.18	7.31	3.30	5.86	7.78	2.52

Note: n = 183; ** p < 0.01, * p < 0.05

has a significant correlation; entrepreneurial team internal heterogeneity (r = 0.10) and professional education (r = 0.11) have significant correlation to some extent. It also verifies the differences and connotations between entrepreneurial team internal heterogeneity and team external heterogeneity.

Hypothesis Validation

Hypothesis 1 suggests that entrepreneurial team heterogeneity has a significant positive impact on entrepreneurial decision-making. To test this hypothesis, we first make entrepreneurial decision a dependent variable. Secondly, we add control variables (gender, age, profession, and educational background), and finally put independent variable (entrepreneurial team heterogeneity) into regression equation. The results of hierarchical regression are listed in Table 3. From Table 3, we can see that entrepreneurial team internal heterogeneity has a significant positive impact on entrepreneurial decision-making (M5, β = 0.20, P < 0.01). The entrepreneurial team external heterogeneity also has a significant positive impact on entrepreneurial decision-making (M6, β = 0.21, P < 0.01). As a result, H1, H1a, and H1b are supported by data.

Based on the analysis steps proposed by Baron and Kenny (1986), we use hierarchical regression to test the mediating role of entrepreneurial team communication in entrepreneurial team heterogeneity and entrepreneurial decision-making. The results of hierarchical regression are listed in Table 3.

Table 4. Mediating effects of entrepreneurial team heterogeneity, team communication and entrepreneurial decision-making

Serial number	Causal path relationship	c	a	b	c'
1	Internal heterogeneity → Entrepreneurial decision-making	0.20			
2	Internal heterogeneity → Team communication		0.33		
3	Internal heterogeneity → Team communication → Entrepreneurial decision-making			0.17	0.15
4	External heterogeneity → Entrepreneurial decision-making	0.21			
5	External heterogeneity → Team communication		0.24		
6	External heterogeneity → Team communication → Entrepreneurial decision-making			0.17	0.18

We can see **Table 3** that the entrepreneurial team internal heterogeneity has significant positive influence on entrepreneurial decision-making (M5, $\beta = 0.20$, $P < 0.01$). Entrepreneurial teams internal heterogeneity also has a significant impact on entrepreneurial team communication (M2, $\beta = 0.33$, $P < 0.01$), and H2 is supported. At the same time, entrepreneurial team communication has a significant positive impact on entrepreneurial decision-making (M7, $\beta = 0.17$, $P < 0.05$). In model 7, the coefficient of entrepreneurial team internal heterogeneity and entrepreneurial decision-making was 0.15, also has significant influence. Therefore, according to the judgment principle of Baron and Kenny, team communication has an intermediary effect between entrepreneurial team internal heterogeneity and entrepreneurial decision-making. Similarly, team communication also plays a mediating role between entrepreneurial team external heterogeneity and entrepreneurial decision-making. Thus, H3, H3a, and H3b are validated.

Next, we calculated the proportion of intermediary effects in the total effect as shown in **Table 4**.

Table 4 shows that the mediating effects of entrepreneurial team internal heterogeneity, team communication, and entrepreneurial decision-making ($c = 0.20$, $a = 0.33$, $b = 0.17$ and $c' = 0.15$) were significant. Therefore, team communication has partial mediating effect between the three variable. H3a is established, and the proportion of mediator effect and total effect is $ab/c = 0.33 \times 0.17 / 0.20 = 0.28$.

Table 4 shows that the mediating effects of entrepreneurial team external heterogeneity, team communication, and entrepreneurial decision-making ($c = 0.21$, $a = 0.24$, $b = 0.17$ and $c' = 0.18$) were significant. Therefore, team communication has partial mediating effect between the three variable. H3b is established, and the proportion of mediator effect and total effect is $ab/c = 0.24 \times 0.17 / 0.21 = 0.19$.

In conclusion, the mediating effect has been tested again. Through this test, the mediating effect of team communication on entrepreneurial team heterogeneity and entrepreneurial decision-making was clarified, and the results of the previous analysis were further strengthened.

Through the above empirical analysis, our theoretical hypothesis has been verified and supported. Entrepreneurial team heterogeneity (including team internal heterogeneity and external heterogeneity) and entrepreneurial team communication positively influence entrepreneurial decision-making. This is consistent with the conclusions of some scholars. The quality of entrepreneurial decision-making is closely related to the internal and external diversification of entrepreneurial teams. The difference of age, value, and educational background of an entrepreneurial team creates an open communication environment, which can stimulate the team's inspiration and awareness of innovation, and ensure the quality of entrepreneurial decision-making. Additionally, the entrepreneurial activities cannot be separated from the depth of communication, and the communication effect of the entrepreneurial team determines the entrepreneurial decision-making, which has also been fully reflected in this article. Finally, the results of the empirical study also show the relationship between entrepreneurial team heterogeneity, team communication and entrepreneurial decision-making, and clarify the internal mechanism between the three.

CONCLUSION AND RECOMMENDATION

This paper takes the entrepreneurial team of college students in China as the research object, and empirically explores the relationship among Entrepreneurial Team Heterogeneity, Team Communication, and Entrepreneurial Decision-making. This paper finds: (1) Entrepreneurial team heterogeneity (internal and external heterogeneity) positively influences entrepreneurial decision-making; (2) Entrepreneurial team communication positively influences entrepreneurial decision-making; (3) Entrepreneurial team communication plays an intermediary role in entrepreneurial team heterogeneity (internal and external heterogeneity) and entrepreneurial decision-making process. At the same time, the conclusions of this study have brought us useful practical inspiration: Although all members of the entrepreneurial team had certain differences in gender, age, education and other aspects, and their views on the same issue also had certain differences, the team members were closely related to each other as a whole. In order to enhance the mutual understanding of the team members and to promote consensus among them, team members must communicate often. Frequent and effective team communication develops entrepreneurial decision-making. Therefore, the members of the entrepreneurial team should communicate in a variety of ways to guide them adequately and effectively.

As an exploratory empirical research, there are still some limitations of this study: Firstly, this paper discusses the relationship and mechanism between entrepreneurial team heterogeneity, team communication, and business decisions, but other variables such as the influence of team conflict and team knowledge integration on entrepreneurial decision-making needs further study. Secondly, due to the limitation of time, energy and cost, the cross-sectional data used in this study cannot reflect the dynamics of entrepreneurial decision-making. As a result, further longitudinal tests can be made through follow-up studies in order to make the conclusions better.

ACKNOWLEDGEMENTS

This work is financially sponsored by 2017 Program for Science & Technology Innovation Talents in Universities of Henan Province (HASTIT), 2017-cxrc-04; Ministry of Education Humanities and Social Science Fund (15YJC630006); Henan Social Science Program of Henan Province in 2016 (2016BJJ017); Research and Practice Project of Education and Teaching Reform of Henan University of Economics and Law in 2017; General Project of Humanities and Social Sciences in Henan Provincial Department of Education in 2018 (2018-ZDJH-015); Key Research Projects of Humanities and Social Sciences of Henan Provincial Department of Education in 2016 (2016-zd-046); 2014 Henan Provincial Government Decision-making Research Tender Topic (2014154); Key Research Projects of Humanities and Social Sciences of Henan Provincial Department of Education in 2014 (2014-zd-011); General Research Project of Humanities and Social Sciences of Henan Provincial Department of Education in 2016 (2016-gh-122); General Research Project of Humanities and Social Sciences of Henan Provincial Department of Education in 2017 (2017-ZZJH-163); Henan Institute of Science and Technology Major Research Projects (2015); 2017 General Program of Philosophy and Social Science Research Project of Henan Institute of Science and Technology; the Major Project of National Social Science Fund (12&ZD206). We would like to thank these institutions for their valuable help.

REFERENCES

- Ancona, D. G. (1990). Outward bound: strategic for team survival in an organization. *Academy of Management Journal*, 33(2), 334-365. doi:10.2307/256328
- Cao, Y., & Jiang, H. (2017). An Empirical Study on the Quality of Entrepreneurship Education based on Performance Excellence Management. *Eurasia Journal of Mathematics, Science & Technology Education*, 13(8), 5663-5763. doi:10.12973/eurasia.2017.01020a
- Cao, Y., Kirilova, G. I., & Grunis, M. L. (2017). Cooperative Research Projects of Master's Students (Education Programs) in the Open Informational Educational Environment. *Eurasia Journal of Mathematics, Science & Technology Education*, 13(7), 2859-2868. doi:10.12973/eurasia.2017.00722a
- Cao, Y., Kurbanova, A. T., & Salikhova, N. R. (2017). Development of Classification Thinking in Future Teachers: Technologies of Reflective Discussion. *Eurasia Journal of Mathematics, Science & Technology Education*, 13(6), 1865-1879. doi:10.12973/eurasia.2017.01205a

- Dufays, F., & Huybrechts, B. (2016). Where do hybrids come from? Entrepreneurial team heterogeneity as an avenue for the emergence of hybrid organizations. *International Small Business Journal*, 34(6), 777-796. doi:10.1177/0266242615585152
- Dufays, F., & Huybrechts, B. (2017). Entrepreneurial teams in social entrepreneurship: When team heterogeneity facilitates organizational hybridity. *Research handbook on entrepreneurial teams: Theory and practice*, 273-287. doi:10.4337/9781784713263.00021
- Eisenhardt, K. M., & Schoonhoven, C. B. (1990). Organizational growth: Linking founding team, strategy, environment, and growth among US semiconductor ventures, 1978-1988. *Administrative science quarterly*, 504-529. doi:10.2307/2393315
- Ensley, M. D., & Hmieleski, K. M. (2005). A comparative study of new venture top management team composition, dynamics and performance between university-based and independent start-ups. *Research policy*, 34(7), 1091-1105. doi:10.1016/j.respol.2005.05.008
- Ensley, M. D., Carland, J. W., & Carland, J. C. (1998). The effect of entrepreneurial team skill heterogeneity and functional diversity on new venture performance. *Journal of Business and Entrepreneurship*, 10(1), 1-14.
- Forsström-Tuominen, H., Jussila, I., & Goel, S. (2017). The Start of Team Start-Ups: Collective Dynamics of Initiation and Formation of Entrepreneurial Teams. *Journal of Enterprising Culture*, 25(1), 31-66.
- Francis, D. H., & Sandberg, W. R. (2000). Friendship within entrepreneurial teams and its association with team and venture performance. *Entrepreneurship: Theory and Practice*, 25(2), 5-5.
- Gundry, L. K., Ofstein, L. F., & Monllor, J. (2016). Entrepreneurial Team Creativity: Driving Innovation from Ideation to Implementation. *Journal of Enterprising Culture*, 24(1), 55-77. doi:10.1142/S0218495816500035
- Hambrick, D. C., Cho, T. S., & Chen, M. J. (1996). The influence of top management team heterogeneity on firms' competitive moves. *Administrative science quarterly*, 659-684. doi:10.2307/2393871
- Hoffman, L. R., & Maier, N. R. (1961). Quality and acceptance of problem solutions by members of homogeneous and heterogeneous groups. *The Journal of Abnormal and Social Psychology*, 62(2), 401. doi:10.1037/h0044025
- Hormiga Pérez, E., Hancock, C., & Jaría Chacón, N. (2017). Going it Alone or Working as Part of a Team: The Impact of Human Capital on Entrepreneurial Decision Making. *Journal of Evolutionary Studies in Business*, 2(1), 201-231.
- Jehn, K. A., Northcraft, G. B., & Neale, M. A. (1999). Why differences make a difference: A field study of diversity, conflict and performance in workgroups. *Administrative science quarterly*, 44(4), 741-763.
- Jiang, H., Xiong, W., & Cao, Y. (2017). Research on the Mechanism of Entrepreneurial Education Quality, Entrepreneurial Self-efficacy and Entrepreneurial Intention in Social Sciences, Engineering and Science Education. *Eurasia Journal of Mathematics, Science & Technology Education*, 13(7), 3709-3721. doi:10.12973/eurasia.2017.00754a
- Keerativutisest, V., & Hanson, B. (2016). Beyond the Task and Maintenance Functions in Groups: Developing External Functions in a High-performing Entrepreneurial Team in Thailand. *South Asian Journal of Business and Management Cases*, 5(1), 30-42. doi:10.1177/2277977916634232
- Khan, M. S. (2017). Entrepreneurial Team Troika: A Call on Integrative Research of Trust, Conflict and Diversity. *Journal on Innovation and Sustainability*, 8(1), 18-31.
- Lechler, T. (2001). Social interaction: A determinant of entrepreneurial team venture success. *Small Business Economics*, 16(4), 263-278. doi:10.1007/978-3-322-81895-9_6
- Pelled, L. H. (1996). Demographic diversity, conflict, and work group outcomes: An intervening process theory. *Organization science*, 7(6), 615-631. doi:10.1287/orsc.7.6.615
- Stewart, G. L., & Barrick, M. R. (2000). Team structure and performance: Assessing the mediating role of intrateam process and the moderating role of task type. *Academy of management Journal*, 43(2), 135-148. doi:10.2307/1556372



Organizational Learning and Organization Innovation in the Tourist Hotels - An Empirical Study

Hsin-Wei Fu

Department of Tourism, I-Shou University, Kaohsiung City, TAIWAN, ROC

Received 18 March 2017 • Revised 11 July 2017 • Accepted 24 August 2017

ABSTRACT

In face of the rapidly changing environment and unpredictability of tourist hotels as well as rising consumer needs, constant learning is necessary for tourist hotels to maintain the competitive advantage and survival. Continuous learning is therefore required for organizations and individuals in tourist hotels; however, the learning levels and types are distinct. To enhance the international competitiveness, a tourist hotel has to effectively absorb, transfer, and even create new knowledge for the effective innovation. For this reason, “organizational learning” and “knowledge creation” become the keys in the future research on innovation. Total 360 copies are distributed, and 304 valid copies are retrieved, with the retrieval rate 84%. The research results are concluded as below. 1) Organizational learning shows significantly positive correlations with knowledge creation. 2) Knowledge creation reveals remarkably positive correlations with organization innovation. 3) Organizational learning presents notably positive correlations with organization innovation. 4) Knowledge creation appears mediation on the relationship between organizational learning and organization innovation. Finally, suggestions, according to the research results, are proposed, expecting to enhance the market share and profitability of tourist hotels and to maintain the sustainable management and development.

Keywords: tourist hotel, organizational learning, knowledge creation, organization innovation

INTRODUCTION

The approach of knowledge economy era reveals that knowledge is not simply the advantage of enterprises under the new economic era, but the mere source of advantage. This is now the era when service industry is the best, and tourism service industry is a service industry with multi-objectives and compound functions and presents great contributions to the foreign exchange earnings of tourism for the government. Tourist hotel enterprises are the power for the development of tourism business as well as the potential service industry due to consumers' expenses and consumption in hotels. In such a knowledge economy era nowadays, traditional marketing for international tourist hotel enterprises could not adapt to such a changing commercial environment, and the satisfaction with customer needs becomes the key success factor in tourism marketing.

Hotel enterprises therefore should grasp the motivation, behaviors, and responses of actual customers and potential customers through the acquisition of market intelligence, understand competitors' products and strategies, evaluate the resources of the organization, and respond to and satisfy with customer needs aiming at the needs and expectation of actual and potential customers. Under the changeable customer needs and fiercely

© **Authors.** Terms and conditions of Creative Commons Attribution 4.0 International (CC BY 4.0) apply.

Correspondence: Hsin-Wei Fu, *Department of Tourism, I-Shou University, No.1, Sec. 1, Syuecheng Rd., Dashu District, Kaohsiung City 84001, Taiwan, ROC.*

✉ hfu@isu.edu.tw

State of the literature

- An organization would change the decision-making plans and directly perform on the information processing when detecting uncertainties and risks in the environment; organizational learning was the process for the change cycle.
- Under the changeable customer needs and fiercely competitive environment, the product life cycle is shortening, and satisfying customers' changeable needs with continuous innovation becomes a primary issue for Tourist Hotels.
- Transforming labor-intensive into knowledge-intensive, applying market intelligence information into organizational learning to create knowledge, and further applying the knowledge to create Tourist Hotels value with innovative products, innovative services, and innovative strategies would be an issue worthy of in-depth understanding.

Contribution of this paper to the literature

- A tourist hotel should encourage the employees' continuous learning, cohere with the corporate culture through learning, reinforce the employees' working abilities, strengthen education and trainings, and enhance the communication and exchange in the organization.
- Organization innovation has become the primary survival condition for a tourist hotels. A tourist hotel organization therefore should continuously innovate, more rapidly understand and cope with current environmental changes than the competitors.
- A tourist hotel could present the competitive advantage by developing personal creativity, having organizational members share, help, and learn with each other.

competitive environment, the product life cycle is shortening, and satisfying customers' changeable needs with continuous innovation becomes a primary issue for current enterprises. In comparison with other industries, tourist hotel enterprises, with higher fixed costs invested, could not often update the hardware facilities. Instead, they could stress on the innovation of soft service and marketing programs. Tourism business is an industry mainly providing services that it relies on large quantity of service personnel and is a labor-intensive industry. In the knowledge economy era nowadays, transforming labor-intensive into knowledge-intensive, applying market intelligence information into organizational learning to create knowledge, and further applying the knowledge to create higher enterprise value with innovative products, innovative services, and innovative strategies would be an issue worthy of in-depth understanding. "Organizational learning" and "knowledge creation" therefore become the key points in the future research on innovation. The relationship among organizational learning, knowledge creation, and organization innovation of tourist hotels is further discussed in this study.

LITERATURE AND HYPOTHESIS

Organizational Learning

Organizational learning is the revision and modification made for the misconception, abnormality, and contradiction of images or recognition (Gronum et al., 2012). Spillane (2015) regarded organizational learning as various adjustments for the fundamental belief, attitude & behavior, and structural arrangement in the process to cope with environmental changes in order to enhance the operating effectiveness and the permanent survival and development of enterprises or institutions. Such adjustments were realized through formal and informal interpersonal interaction (Kaiser et al., 2013). An organization would change the decision-making plans and directly perform on the information processing when detecting uncertainties and risks in the environment; organizational learning was the process for the change cycle (Carey et al., 2011). Organizational learning required the integration of an organization and the environment for maintaining the competitive advantage and innovation. In this case, an organization, based on the past experiences, had to present the potential of learning, unlearning, and relearning. Organizational adaptiveness was a strategy as well as the activity to adapt to external changing environments, as adaptiveness would guide an organization to constant learning (Lubik et al., 2013). Organizational learning is the knowledge and skills for changing behaviors and actions that it could help an organization cope with external

changing environments. Organizational learning was developed through vision, knowledge, mental model, and the share of past knowledge experiences as well as the major process to generate management innovation. It emphasized that organizational learning was the spontaneous output and process going through the past knowledge and experiential learning of an organization (Duggan, 2012). Organizational learning referred to organizational members constantly expanding the abilities, cultivating a brand-new and broad thinking method, and continuously learning how to learn (Phelps et al., 2012).

Referring to Chen et al. (2012), organizational learning covers three stages of information acquisition, information dissemination, and shared information interpretation. The sources of organizational information acquisition might be the internal organization, e.g. learning curve and empirical curve, or other external experiences, such as customer research survey or other second-hand data. Moreover, the source of information might be the organizational memory, which was transferred into knowledge from past experiences. Apparently, organizational learning becomes the internalized memory of an organization through the acquisition of intelligence, delivery & sharing, and further analyses and transformation to further become the source of organizational information.

Knowledge Creation

Fernhaber & Patel (2012) indicated that the economy and capability of modern enterprises lied in the knowledge and service, rather than the hardware assets of land, factories, or equipment. It revealed that the value of most products and services relied on knowledge-based intangible assets. Müller-Seitz (2012) considered that knowledge was the competitiveness of an enterprise, and the employees' knowledge was the primary asset of the enterprise. "Service economy" would replace "manufacturing economy", while knowledge workers would replace traditional labors in the future. For most service enterprises, employees' intelligence and wisdom were the key resources (Koolen, 2013). Ali & Yangaiya (2015) revealed that the basic requirement for the organizational design of knowledge creation was to provide a basic structure for processing organizational information so that the members could continuously and repeatedly acquire, create, and accumulate new organizational knowledge. The theory of knowledge creation explained that explicit memory could re-create knowledge through the acquisition of external intelligence, information, and knowledge. Besides, implicit knowledge depended on the open mental model of organizational members' mutual sharing and circulation. Schildt et al. (2012) also stressed on the implicit knowledge in organizational members' mind and indicated that the next economic growth would be the knowledge-based business. An enterprise had to become a knowledge-based organization to maintain the competitiveness, and the cultivation of organizational culture and the planning of incentive system could encourage enterprise employees being willing to share personal knowledge and experiences so that individual knowledge could be rapidly expanded to become the team knowledge and accumulate the organizational knowledge. Hoch (2014) revealed that employees' knowledge and wisdom being thoroughly utilized and emphasized was the key of the sustainable management of an enterprise. Furthermore, knowledge creation was the new knowledge created by organizational members sharing the knowledge experiences with constant communication, sharing, and discussions.

Referring to Chen et al. (2014), knowledge creation is defined as organizational members applying market intelligence information to the analysis and thinking, with new concepts and new points of view, to further create new knowledge, which is disseminated to the entire organization and integrated into products and services.

Organization Innovation

Innovation is an endogenous variable of economic growth. In other words, engaging in affairs with different methods in any economic life could be innovation (Graen et al., 2013). All changes which could have existing resources present the potential to generate wealth could be innovation (Seebode et al., 2012). Innovation was a new idea, which could be applied to start or enhance certain products, processes, or services, including product innovation, new production process and technology, new structure and management systems, and new plans and management programs (Koskinen, 2012). Sustainable growth was about the key success factor of all

successful enterprises, and innovation was the key factor in the growth. An enterprise could acquire long-term success merely by constantly creating innovative products, systems, and services and the departments conforming to customer demands (Bergman et al., 2012). The definition of organization innovation could be explained from three points. (1) Organization innovation was the newly allocated creative process composing more than two existing ideas or entities that it showed the same meaning as invention. (2) Organization innovation lied in novelty that it could be regarded as a new creativity. (3) Organization innovation was the process of an individual or the social system accepting, developing, and executing new creativity (Hsieh, 2013). Organization innovation could be a new product, technology, service, management system, or organizational plan (Nieves et al., 2014). Organization innovation was the generation, acceptance, and execution of new concepts, procedures, products, or services, including four processes of product creativity, alliance creativity, realization creativity, and migration creativity. It covered the transformation and application of new knowledge, the connection of information, the change of service, and the reutilization of resources (Tidd & Bessant, 2014).

Referring to Chou & Lee (2015), dual-core model is used for exploring the types of organization innovation, from which two dimensions of “management innovation” and “technology innovation” are deduced.

- (1) Management innovation: Referring to the contributions of plans, organizations, employment, leadership, and control, which are either purchased externally or existing internally, affirmed by organizational members.
- (2) Technology innovation: Indicating the contributions of equipment, processes, and products, which are either purchased externally or existing internally, affirmed by organizational members.

Relationship between Organizational Learning and Knowledge Creation

Taylor (2013) revealed that an enterprise would seek for required intelligence and information from external organizations, such as suppliers, customers, distributors, or government departments, and even search for new clues or concepts from competitors to create new knowledge. Spillane (2015) proposed that an organization, in highly competitive environments, would acquire necessary intelligence and information through customers and competitors to create knowledge. When external environments were stable, old knowledge and experiences in the organizational memory were utilized for creating the knowledge required for the organization (Lubik et al., 2013). Chen et al. (2012) discovered that an enterprise systemized the past accumulated customer knowledge and accumulated distinct customer knowledge to create knowledge and further innovate the service. Furthermore, other cases also revealed that the source of innovative knowledge had to focus on the information of external markets, the information of customer knowledge changes, and the information acquired by employees (Duggan, 2012). Apparently, knowledge creation and innovation had to cover the search of internal organizational memory as well as stressed on the acquisition of customers’ and competitors’ intelligence information. The following hypothesis is then proposed in this study.

H1: Organizational learning shows significantly positive correlations with knowledge creation.

Relationship between Knowledge Creation and Organization Innovation

Whipple et al. (2015) regarded organizational knowledge creation as the key in enterprise innovation. An organization being able to create knowledge would guide the organization for innovation. Ali & Yangaiya (2015) discovered that the innovation of organizational service came from the application of knowledge. Specifying and systemizing the past served customers’ knowledge into the database of an organization could be the basis for providing customers with new value. In the research on the relationship of knowledge creation, organizational learning, and innovation with organization innovation performance, Su & Carney (2013) proved the significant effect of knowledge creation on organization innovation. In the research on the market orientation, market knowledge management, product innovation, and performance of hi-tech industry in Taiwan, Chen et al. (2014) revealed the positive effect of knowledge creation on product innovation. Accordingly, the following hypothesis is proposed in this study.

H2: Knowledge creation reveals remarkably positive correlations with organization innovation.

Relationship between Organizational Learning and Organization Innovation

Under same conditions, organizational learning could enhance the capability of organization innovation (Hsieh, 2013). Organizational learning showed close correlations with organization innovation (Su et al., 2013), and the learning climate in an organization could promote the innovation capability (Nieves et al., 2014). Accelerating an organization's learning could enhance the management innovation and promote the competitiveness (Yen et al., 2012). In this case, mutual learning in the organization and observing the changes of external environments were the key factors in an enterprise coping with innovation, customer needs, technical turmoil, and uncertainties in the competitive environment (Graen et al., 2013). An organization devoting to learning could present stronger innovation capability than the competitors, mainly because the organization could closely detect the competitors' market actions, understand the advantages and shortages of the competitors and learn the success, as well as learn the lesson from the failure (Wilden et al., 2013). Chou & Lee (2015) mentioned that in the unrest competitive environment, organization innovation was related to the survival of an organization, and the organizational learning culture could improve the innovation process (Koskinen, 2012). As a result, the following hypotheses are proposed in this study.

H3: Organizational learning presents notably positive correlations with organization innovation.

H4: Knowledge creation appears mediation on the relationship between organizational learning and organization innovation.

RESEARCH DIMENSION AND METHODOLOGY

Definition of Research Dimension

Organizational learning

According to Chen et al. (2012), the sources of organizational learning are divided into information acquisition, information dissemination, and shared information interpretation in this study.

1. Information acquisition: The sources might come from internal organization, such as learning curve and empirical curve, or other external experiences, e.g. customer research survey or other second-hand data. What is more, the source of information might be the organizational memory, which is transferred into knowledge from past experiences.
2. Information dissemination: Organizational learning is the dissemination of acquired intelligence through internal or external organization.
3. Shared information interpretation: Organizational intelligence is shared and further analyzed and transferred to become the internalized memory and further become the source of organizational information.

Knowledge creation

Referring to Chen et al. (2014), knowledge creation is defined as organizational members applying market intelligence information to the analyses and thinking, with new concepts and new points of view, to further create new knowledge, which is then disseminated to the entire organization and integrated into products and services.

Organization innovation

Referring to Chou & Lee (2015), innovation is defined to explore the type of organization innovation, with dual-core model, to deduce the dimensions of "management innovation" and "technology innovation".

1. Management innovation: Indicating the contributions of various plans, organizations, employment, leadership, and control, which are either purchased externally or existing internally, affirmed by organizational members.
2. Referring to the contributions of equipment, processes, and products, which are either purchased externally or existing internally, affirmed by organizational members.

Research Subject

Aiming at international tourist hotels in Taipei areas, the supervisors and employees are distributed 360 copies of questionnaire. Total 304 valid copies are retrieved, with the retrieval rate 84%. The international tourist hotels in Taipei areas contain The Grand Hotel, The Ambassador Hotel, Mandarin Oriental, Imperial Hotel, Gloria Prince Hotel, Emperor Hotel, Hotel Riverview Taipei, Hilton Hotels & Resorts, Golden China Hotel, Asia Pacific Hotel, Brother Hotel, Santos Hotel, The Landis Taipei Hotel, United Hotel, Lai Lai Hotel, Taipei Fortuna Hotel, Sunworld Dynasty Hotel, Hotel Royal-Nikko Taipei, Howard Hotel, Taipei Fullerton Hotel, Grand Hyatt Taipei, Regent Taipei, The Sherwood Taipei, Shangri-La Hotel, and Leefoo Resort.

Analysis

Regression Analysis is applied to understand the relationship among organizational learning, knowledge creation, and organization innovation.

ANALYSIS AND DISCUSSION

Factor Analysis of Organizational Learning

The organizational learning scale, with Factor Analysis, is extracted three factors of “information acquisition” (eigenvalue=3.472, $\alpha=0.86$), “information dissemination” (eigenvalue=2.551, $\alpha=0.83$), and “shared information interpretation” (eigenvalue=2.136, $\alpha=0.88$). The accumulative covariance explained achieves 79.662%.

The accumulative covariance explained of the knowledge creation scale, with Factor Analysis (eigenvalue=4.253, $\alpha=0.82$), reaches 82.173%.

The organization innovation scale, with Factor Analysis, is extracted two factors of “management innovation” (eigenvalue=3.215, $\alpha=0.81$) and “technology innovation” (eigenvalue=3.463, $\alpha=0.80$). The accumulative covariance explained achieves 80.467%.

Correlation Analysis of Organizational Learning and Knowledge Creation

Regression Analysis is utilized in this study to test the hypotheses and the theoretical structure. The first regression, **Table 1**, reveals the significance of the regression equation ($F=23.3428$, $p<0.001$). Organizational learning shows significant effects on knowledge creation, where “information acquisition”, “information dissemination”, and “shared information interpretation” in organizational learning reveal remarkably positive effects on knowledge creation ($\beta=2.433$, $p<0.01$; $\beta=1.862$, $p<0.05$; $\beta=2.517$, $p<0.001$) that H1 is supported.

Correlation Analysis of Organizational Learning and Knowledge Creation towards Organization Innovation

Applying Regression Analysis to test the hypotheses and the theoretical structure, the first regression, **Table 2**, presents the significance of regression equation ($F=18.512$, $p<0.001$). Organizational learning shows notable effects on management innovation, where “information acquisition”, “information dissemination”, and “shared information interpretation” in organizational learning reveal significantly positive effects on management innovation ($\beta=2.155$, $p<0.01$; $\beta=2.241$, $p<0.01$; $\beta=2.577$, $p<0.001$). The third regression, **Table 2**, presents the significance of the regression equation ($F=21.834$, $p<0.001$). Organizational learning appears significant effects on

Table 1. Regression Analysis of organizational learning and knowledge creation

Dependent variable	Knowledge creation	
Independent variable		
Organizational learning	β	ρ
Information acquisition	2.433**	0.000
Information dissemination	1.862*	0.016
Shared information interpretation	2.517***	0.000
F	23.342	
P	0.000***	
R2	0.266	
Adjusted R2	0.231	

Note: * stands for $p < 0.05$, ** for $p < 0.01$, and *** for $p < 0.001$

Table 2. Regression Analysis of organizational learning and knowledge creation towards organization innovation

Dependent variable	Organization innovation							
	Management innovation				Technology innovation			
Independent variable	β	ρ	β	ρ	β	ρ	β	ρ
Organizational learning								
Information acquisition	2.155**	0.000			2.352**	0.000		
Information dissemination	2.241*	0.000			2.438**	0.000		
Shared information interpretation	2.577***	0.000			2.523***	0.000		
Knowledge creation			3.166***	0.000			3.227***	0.000
F	18.512		22.433		21.834		28.652	
P	0.000***		0.000***		0.000***		0.000***	
R2	0.251		0.286		0.315		0.368	
Adjusted R2	0.225		0.261		0.283		0.338	

Note: * stands for $p < 0.05$, ** for $p < 0.01$, and *** for $p < 0.001$

technology innovation, where “information acquisition”, “information dissemination”, and “shared information interpretation” in organizational learning show remarkably positive effects on technology innovation ($\beta = 2.352$, $p < 0.01$; $\beta = 2.438$, $p < 0.01$; $\beta = 2.523$, $p < 0.001$) that H3 is supported.

The second regression, **Table 2**, reveals the significance of the regression equation ($F = 22.433$, $p < 0.001$). Knowledge creation presents notable effects on management innovation ($\beta = 3.166$, $p < 0.001$). The fourth regression, **Table 2**, shows the significance of the regression equation ($F = 28.652$, $p < 0.001$). Knowledge creation appears remarkable effects on management innovation ($\beta = 3.227$, $p < 0.001$) that H2 is supported.

Mediation of Organizational Learning and Knowledge Creation on Organization Innovation

The mediation of knowledge creation in this study is shown as Hierarchical Regression Analysis in **Table 3**. Organizational learning could notably explain management innovation ($F = 18.512$, $p < 0.001$). According to Model 2, where the effects of organizational learning and knowledge creation on management innovation are considered to discuss the mediation of knowledge creation, the β of information acquisition significantly drops from 2.155 ($p < 0.01$) down to 1.896 ($p < 0.05$), revealing that knowledge creation would reduce the direct effect of information acquisition on management innovation. Second, the β of information dissemination notably drops from 2.241 ($p < 0.01$) down to 1.945 ($p < 0.01$), showing that knowledge creation would reduce the direct effect of information dissemination on management innovation. Furthermore, the β of shared information interpretation significantly drops from 2.577 ($p < 0.001$) down to 2.273 ($p < 0.01$), presenting that knowledge creation would reduce the direct effect

Table 3. Hierarchical Regression of organizational learning and knowledge creation towards organization innovation

Dependent variable→	Organization innovation							
	Management innovation				Technology innovation			
	Model 1		Model 2		Model 1		Model 2	
Independent variable↓	β	ρ	β	ρ	β	ρ	β	ρ
Information acquisition	2.155**	0.000	1.896*	0.015	2.352**	0.000	2.021**	0.002
Information dissemination	2.241*	0.000	1.945*	0.008	2.438**	0.000	2.142**	0.000
Shared information interpretation	2.577***	0.000	2.273**	0.000	2.523***	0.000	2.234**	0.000
Knowledge creation			3.438**	0.000			2.291**	0.000
F	18.512		34.521		21.834		38.557	
P	0.000***		0.000***		0.000***		0.000***	
R2	0.251		0.363		0.315		0.423	
Adjusted R2	0.225		0.322		0.283		0.396	

Note: * stands for $p < 0.05$, ** for $p < 0.01$, and *** for $p < 0.001$

of shared information interpretation on management innovation. The research results show the partial mediation of knowledge creation on the relationship between organizational learning and management innovation.

Organizational learning could notably explain technology innovation ($F=21.834$, $p < 0.001$). According to Model 2, where the effects of organizational learning and knowledge creation on technology innovation are taken into account to discuss the mediation of knowledge creation. The β of information acquisition remarkably drops from 2.352 ($p < .01$) down to 2.021 ($p < .01$), revealing that knowledge creation would reduce the direct effect of information acquisition on technology innovation. Second, the β of information dissemination notably drops from 2.438 ($p < .01$) down to 2.142 ($p < .01$), presenting that knowledge creation would reduce the direct effect of information dissemination on technology innovation. What is more, the β of shared information interpretation significantly drops from 2.523 ($p < .001$) down to 2.234 ($p < .01$), showing the direct effect of knowledge creation on the relationship between shared information interpretation and technology innovation. Accordingly, knowledge creation appears partial mediation on the relationship between organizational learning and technology innovation that H4 is supported.

CONCLUSION

The research results show that tourist hotels with high organizational learning would create higher knowledge. Knowledge creation of a tourist hotel relies on the knowledge transfer, and knowledge creation should present sufficient intelligence information. The knowledge required for a tourist hotel could be created by the organizational members analyzing the intelligence information and transferring to text information or becoming an experience and then analyzing with other members with open mental model. The organizational members of a tourist hotel constantly acquire knowledge, transfer knowledge, and restore knowledge through the operation of the knowledge system. More importantly, knowledge creation is based on a knowledge system, but requires the mutual exchange and discussion among organizational members. Such a delivery process is a social-pattern knowledge exchange theory. A tourist hotel has to properly apply knowledge exchange theory to create higher-level knowledge so as to generate new concepts and new ideas about intelligence and information. Knowledge creation of a tourist hotel relies on the real experiences; the responses of an organization is the execution of entire organizational members through brainstorming and in-depth discussions to achieve the consensus; the knowledge creation process requires the constant debate and thinking among the members to activate the knowledge and innovate the knowledge; and, knowledge creation of a tourist hotel is the accumulation of wisdom value, which is derived from knowledge creation, to thicken the organizational capital.

SUGGESTION

Aiming at the research results on organizational learning, knowledge creation, and organization innovation of tourist hotels, the following suggestions are proposed as following.

1. A tourist hotel should encourage the employees' continuous learning, cohere with the corporate culture through learning, reinforce the employees' working abilities, strengthen education and trainings, and enhance the communication and exchange in the organization. The information circulation and discussion among departments in a tourist hotel organization would help enhance the learning climate in the organization and enhance the colleagues' understanding of the market and familiarity of organizational management.
2. In the fiercely competitive environment, organization innovation has become the primary survival condition for a tourist hotel. A tourist hotel organization therefore should continuously innovate, more rapidly understand and cope with current environmental changes than the competitors, and improve the products and services by understanding customers' external knowledge so as to promote the overall knowledge creation and organization innovation of a tourist hotel organization.
3. In a tourist hotel system, a supervisor is likely not to put down the authority and to ignore others' good suggestions because of the persistence in self-concept or different positions. In this case, a tourist hotel supervisor should open the mind and listen to others' opinions. Tourist hotel employees, when encountering problems, should discuss with the supervisors, rather than simply listening to orders. Everyone has the traits. A tourist hotel could present the competitive advantage by developing personal creativity, having organizational members share, help, and learn with each other, and further has the tourist hotel organization form the natural learning relationship.

REFERENCES

- Ali, H. M., & Yangaiya, S. A. (2015). Investigating the influence of distributed leadership on school effectiveness: A mediating role of teachers' commitment. *Journal of Educational and Social Research*, 5(1), 163-174.
- Bergman, J. Z., Rentsch, J. R., Small, E. E., Davenport, S. W., & Bergman, S. M. (2012). The shared leadership process in decision-making teams. *The Journal of Social Psychology*, 152(1), 17-42.
- Carey, S., Lawson, B., & Krause, D. R. (2011). Social capital configuration, legal bonds and performance in buyer-supplier relationships. *Journal of Operations Management*, 29(4), 277-288.
- Chen, J., Guo, Y., & Zhu, H. (2012). Can me-too products prevail? Performance of new product development and sources of idea generation in China—an emerging market. *R&D Management*, 42(3), 273-288.
- Chen, Y. H., Lin, T. P., & Yen, D. C. (2014). How to facilitate inter-organizational knowledge sharing: The impact of trust. *Information & Management*, 51(5), 568-578.
- Chou, Y. C., & Lee, J. H. (2015). What most matters in strengthening educational competitiveness? : An application of FS/QCA method. *Procedia – Social and Behavioral Sciences*, 197, 2181-2190.
- Duggan, W. (2012). *Creative Strategy: A Guide for innovation*. New York: Columbia University Press.
- Fernhaber, S. A., & Patel, P. C. (2012). How do young firms manage product portfolio complexity? The role of absorptive capacity and ambidexterity. *Strategic Management Journal*, 33(13), 1516-1539.
- Graen, G. B., & Graen, J. A. (2013). *Management of Team Leadership in Extreme Context: Defending Our Homeland, Protecting Our First Responders*. NY: Information Age Pub Inc.
- Gronum, S., Verreynne, M. L., & Kastle, T. (2012). The Role of Networks in Small and Medium-Sized Enterprise Innovation and Firm Performance. *Journal of Small Business Management*, 50(2), 257-282.
- Hoch, J. (2014). Shared leadership, diversity, and information sharing in teams. *Journal of Managerial Psychology*, 29(5), 541-564.
- Hsieh, W. L. (2013). *The innovation value chain and export performance: a study of Taiwanese manufacturing industries* (Doctoral dissertation, Aston University).

- Kaiser, A., Feldhusen, B., & Fordinal, B. (2013). Vision development as a knowledge creating process. In *2013 46th Hawaii International Conference on System Sciences (HICSS)*, 3593-3602, IEEE.
- Koolen, M. J. (2013). *Knowledge Exploitation for the Development of New Services* (Doctoral dissertation, Eindhoven University of Technology).
- Koskinen, K. U. (2012). Knowledge integration in systems integrator type project-based companies: a systemic view. *International Journal of Managing Projects in Business*, 5(2), 285-299.
- Lubik, S., Garnsey, E., Minshall, T., & Platts, K. (2013). Value creation from the innovation environment: partnership strategies in university spin-outs. *R&D Management*, 43(2), 136-150.
- Müller-Seitz, G. (2012). Absorptive and desorptive capacity-related practices at the network level—the case of SEMATECH. *R&D Management*, 42(1), 90-99.
- Nieves, J., Quintana, A., & Osorio, J. (2014). Knowledge-based resources and innovation in the hotel industry. *International Journal of Hospitality Management*, 38, 65-73.
- Phelps, C., Heidl, R., & Wadhwa, A. (2012). Knowledge, networks, and knowledge networks a review and research agenda. *Journal of Management*, 38(4), 1115-1166.
- Schildt, H., Keil, T., & Maula, M. (2012). The temporal effects of relative and firm-level absorptive capacity on interorganizational learning. *Strategic Management Journal*, 33(10), 1154-1173.
- Seebode, D., Jeanrenaud, S., & Bessant, J. (2012). Managing innovation for sustainability. *R&D Management*, 42(3), 195-206.
- Spillane, J. P. (2015). Leadership and learning: Conceptualizing relations between school administrative practice and instructional practice [Monograph]. *Societies*, 2015(5), 277-294.
- Su, E., & Carney, M. (2013). Can China's family firms create intellectual capital? *Asia Pacific Journal of Management*, 30(3), 657-675.
- Su, Z., Peng, J., Shen, H., & Xiao, T. (2013). Technological capability, marketing capability, and firm performance in turbulent conditions. *Management and Organization Review*, 9(1), 115-137.
- Taylor, G. (2013). Implementing and maintaining a knowledge sharing culture via knowledge management teams: A shared leadership approach. *Journal of Organizational Culture, Communication and Conflict*, 17(1), 69-92.
- Tidd, J., & Bessant, J. (2014). *Strategic innovation management*. New York: John Wiley & Sons.
- Whipple, J. M., Wiedmer, R., & K Boyer, K. (2015). A Dyadic Investigation of Collaborative Competence, Social Capital, and Performance in Buyer-Supplier Relationships. *Journal of Supply Chain Management*, 51(2), 3-21.
- Wilden, R., Gudergan, S. P., Nielsen, B. B., & Lings, L. (2013). Dynamic capabilities and performance: strategy, structure and environment. *Long Range Planning*, 46(1-2), 72-96.
- Yen, H. R., Wang, W., Wei, C.-P., Hsu, S. H.-Y., & Chiu, H.-C. (2012). Service innovation readiness: Dimensions and performance outcome. *Decision Support Systems*, 53(4), 813-824.

<http://www.ejmste.com>



OPEN ACCESS

EURASIA Journal of Mathematics Science and Technology Education
ISSN: 1305-8223 (online) 1305-8215 (print)
2017 13(9):6357-6368
DOI: 10.12973/eurasia.2017.01070a



Transformational Leadership Behavior and Turnover Intention in China Physical Education

Yuan Wang

College of Physical Education and Sports, Beijing Normal University, Beijing 100875, CHINA

Ti Hu

College of Physical Education and Sports, Beijing Normal University, Beijing 100875, CHINA

Received 17 May 2017 • Revised 22 July 2017 • Accepted 5 September 2017

ABSTRACT

High-level sports teams in universities are crucial for cultivating high-level athletes in China. Currently, coaches are the most direct managers of university (including colleges) sports teams in China, with their management styles and approaches having a direct impact on athletes' psychology. This study focused on high-level university football teams and explored the impact of transformational leadership on athlete turnover intention. The mediating effect of the "coach-athlete relationship," which helps establish and develop high-level university sports teams in China, was also examined. Overall, coaches with a transformational leadership style were found to have a significant effect on reducing athlete turnover intention and enhancing the coach-athlete relationship. In fact, the effect of coaches' transformational leadership behavior on athlete turnover intention is mediated through the coach-athlete relationship.

Keywords: high-level university sports teams, transformational leadership behavior, turnover intention, coach-athlete relationship

INTRODUCTION

Integrating sports and education, using the science and technological advantages of universities (including colleges) to develop competitive sports, and including competitive sports in universities to cultivate high-level athletes, are key strategies that have been used to develop the competitive sports industry in China (Hu & Yao, 2015). These strategies are also indicative of the main direction in which competitive sports in China will continue to develop: namely, with universities undertaking more tasks in athletic talent cultivation. Against the backdrop of a recent vigorous growth in interest in football in China, high-level football teams at Chinese universities have begun to receive widespread attention and have achieved rapid development. At the end of 2015, the Ministry of Education explicitly encouraged and pledged support for qualified universities to establish high-level football teams in its "Notification on Accomplishing the Task of Unique Student Recruitment for Universities in 2016." During the 2017 plenary sessions of the National People's Congress and the National Committee of the Chinese People's Political Consultative Conference, the Ministry of Education also predicted that the number of universities recruiting high-level football players in the future will increase to 200. The Ministry added that these universities' future high-level football teams will usher in "the golden period" for athletic talent development.

However, the rapid development of high-level football and sports teams in Chinese universities has also yielded numerous problems that urgently require solutions. Chief among them is the unenthusiastic high-level training and competition, which can trigger high turnover intention among athletes. Other complications, such as

© **Authors.** Terms and conditions of Creative Commons Attribution 4.0 International (CC BY 4.0) apply.

Correspondence: Ti Hu, College of Physical Education and Sports, Beijing Normal University, Beijing 100875, China.

✉ huti777@126.com

State of the literature

- Integrating sports and education, using the science and technological advantages of universities (including colleges) to develop competitive sports, and including competitive sports in universities to cultivate high-level athletes, are key strategies that have been used to develop the competitive sports industry in China
- It is a crucial mechanism by which transformational leadership is able to affect employees' psychological variables; namely, managers' behaviors can engender admiration and spiritual, conceptual, and moral recognition in employees when the managers are able to establish rapport with their employees.
- Focus was directed on college high-level football team coaches in China to elucidate the relationship between coaches' transformational leadership behavior and athletes' turnover intention, and explore the mediating effect of the "coach-athlete relationship." By uncovering the management practices of high-level university sports teams.

Contribution of this paper to the literature

- The research results indicated that the transformational leadership behaviors of high-level university football team coaches have a negative effect on athlete turnover intention; in other words, coaches' transformational leadership behaviors reduce the development of athletes' desires and intent to leave a team.
- In the present study, it was discovered that transformational leadership behavior was significantly related to the Chinese-contextualized SSG theory, with the results indicating that the transformational leadership behaviors of high-level university football team coaches had a significant positive impact on the coach-athlete relationship.
- The coach-athlete relationship had a mediating effect between transformational leadership and turnover intention because the "charisma" dimension in the transformational leadership theory refers to a coach's personal characteristics, which always exist without the need to develop a connection with athletes.

inadequate funding, the lack of an incentive mechanism, an incomplete management mechanism, and inconsistent levels of sports team members, have also been prevalent. Coupled with the lack of high-level competition opportunities for some college sports teams, many outstanding high-level college athletes (in particular those who play highly popular sports such as football) have opted to join club teams to compete out of economic and other interests. Over the long term, this result may drive other athletes to leave, and thereby avoid the tedious trainings and stiff competition of, high-level sports teams. Improving high-level university athletes' enthusiasm for participating in training and competition, while simultaneously reducing their desire to leave sports teams due to the existing conditions, are core challenges that must be addressed as more high-level university sports teams are established and developed.

Athletes' desire to leave a sports team to the extent that it affects their regular training and competitiveness is known as turnover intention. March and Simon (1958) introduced the idea of turnover intention, arguing that an employee's decision to leave mainly depends on the comfort brought by their current job compared with the results of their subjective willingness to change (Bowen & Siehl, 1997; Wu & Tai, 2016). Because employee resignation causes numerous adverse effects to organizations, excessive voluntary resignation from employees is not an event with which organizations are content (Wu, Tsai & Yeh, 2014); thus, this topic has received widespread attention from management researchers. In the field of sports research, the turnover intention of student athletes has been studied by several foreign scholars (Turner & Pack, 2013); however, this problem has not been studied by Chinese scholars, with the few sports-related turnover intention studies focusing on physical education teachers and sports industry employees (Zhang, Gang & Zhang, 2010).

Research has verified that managers' transformational leadership behaviors have a substantial impact on employees' turnover intention (Geyer, 1998). Similarly, the leadership behaviors of direct managers for university football teams in China (mostly coaches) affect athletes with regards to training motivation, self-efficacy, team performance, team cohesion, and role involvement (Wu et al., 2014; Wu & Tai, 2016; Yan, Zhu & Li, 2017). However, no studies have yet explored the relationship between coaches' transformational leadership behaviors and athletes' turnover intentions, or determined the mechanism between the two actions. In related research on transformational

leadership and employee's psychological variables, the superior-subordinate relationship is often viewed as an essential mediator. It is a crucial mechanism by which transformational leadership is able to affect employees' psychological variables; namely, managers' behaviors can engender admiration and spiritual, conceptual, and moral recognition in employees when the managers are able to establish rapport with their employees. This connection facilitates the common pursuit of personality goals and the effective achievement of organizational tasks.

In the present study, it is similarly argued that superior-subordinate relationships play a crucial role in the relationship between transformational leadership and psychological variables (including turnover intention). Focus was directed on college high-level football team coaches in China to elucidate the relationship between coaches' transformational leadership behavior and athletes' turnover intention, and explore the mediating effect of the "coach-athlete relationship." By uncovering the management practices of high-level university sports teams, the results of this study can be used to develop more appropriate management strategies for high-level university sports teams in China.

LITERATURE REVIEW

Transformational Leadership and Turnover Intention

Organizational managers' leadership approaches, styles, and behaviors all affect subordinate employees' psychology, thereby directly impacting the performance of employees and organizations. The same phenomenon occurs in sports teams, wherein coaches' leadership behaviors directly influence team results. In 1978, Burn proposed two major leadership types: transactional leadership and transformational leadership (Bass, 1978). Transactional leadership is primarily based on exchange and a series of implicit contracts, with leaders meeting subordinates' immediate interests mainly to facilitate subordinate management (Bass, 1999). By contrast, transformational leadership cultivates and enhances subordinates' awareness through the pursuit of higher ideals and moral values (e.g., freedom, democracy, fairness, peace, and humanity). Studies have confirmed that compared with transactional leadership, transformational leadership can lead to higher employee satisfaction and better organizational performance.

Bass (1995) further expanded the concept of transformational leadership, asserting that transformational leadership triggers subordinates' high-level needs (here, transformational leadership is presented based on Maslow's hierarchy of needs) by making employees aware of the significance of undertaking organizational tasks (Bass, 1999). An atmosphere of mutual trust is thus established, prompting subordinates to sacrifice their own interests for the benefit of organizations and enabling those organizations to achieve results that surpass expectations. Because the theory of transformational leadership is highly inclusive, it provides a broad basis for the mechanism of leadership; it also includes multiple levels and angles of leadership, concepts that already have broad fundamental perspectives. Thus, transformational leadership remains one of the focal topics in leadership research today.

Since the mid-1990s, sports research has incorporated the concept of transformational leadership, with scholars discovering that managers' transformational leadership behaviors in sports organizations are closely related to athlete satisfaction, organizational commitment, and performance (Pruijn, 1995; Wallace & Weese, 1995; Doherty & Danylchuk, 1996). Early research subjects in such studies were not coaches, but rather were sports organization managers (e.g., campus recreation directors and athletic directors); however, by the early 2000s, researchers began to focus on coaches' leadership behaviors. These studies have revealed that athletes perform passively when their coaches display similar behaviors (and vice versa), and have concluded that a successful coach demonstrates transformational leadership and possesses characteristics such as a passion for work (Donohue et al., 2007), humility, professional ethics, enthusiasm, a positive work attitude, ability to delegate tasks, the capacity to work with others, and the ability to build up others into unique individuals (Wu et al., 2014; Wu, Tsai & Tai, 2016). These coaches establish unique and positive relationships with numerous stakeholders (including athletes) in the course of their coaching, which helps promote others' success (Pharion, 2014). Prior studies also noted that coaches

who engage in transformational leadership establish a clear vision and development strategy for their team, and appropriately lead their subordinates (athletes) so that the vision become a reality (Hampson & Jowett, 2014).

Other studies have explored coaches' relationships with their athletes, and the effect that that relationship has on athlete psychology, athlete behaviors, and team performance. For example, Yan et al. (2017) examined the relationship between short-track speed skating coaches' transformational leadership behaviors and their skaters' role involvement. Elsewhere, Jung and Sosik (2002) have analyzed the relationship between coaches' transformational leadership behaviors and team collective efficacy. A study by Cronin et al. (2015) investigated the relationship between coaches' transformational leadership behaviors and athletes' work cohesiveness, whereas a study by Price and Weiss (2013) highlighted the relationship between coaches' leadership behaviors and juvenile athletes' psychology and team performance based on transformational leadership theory.

Turnover intention refers to the intent of employees to voluntarily leave an organization or profession (Mobley, Griffeth, Hand & Meglino, 1979). Because employees generally choose to leave voluntarily after careful consideration, turnover intention tends to be revealed before formal turnover (Bluedom, 1982), and is thus the most effective predictor of employee turnover behavior (Hom, Mitchell, Lee & Griffeth, 2012). As noted earlier, employee turnover intention has a substantial impact on organizations; thus, reducing turnover intention is a key concern for organizations, from both a theoretical and practical perspective. According to prior research, transformational leadership behaviors have a negative impact on turnover intention; that is, transformational leadership behaviors can reduce employee turnover intention. In the present study, it is argued that the impact of transformational leadership primarily manifests in three ways: (a) it prompts employees to maintain a positive mood and produces in the employees a psychological dependence on their superiors, thus strengthening the association between organization and employee; (b) it enables employees to internalize organization values and an organization identity, again strengthening the association between organization and employee; and (c) it triggers high expectations in employees and induces feelings of being essential to the organization.

To date, few studies have explored the relationship between coaches' transformational leadership behaviors and athletes' turnover intentions, possibly because actual turnovers rarely occur in university sports teams. However, despite this rarity, training and competition are still greatly affected when athletes display turnover intention; in team-based sports such as football, team performance is also highly affected by turnover intention. Therefore, the following hypothesis was proposed:

- H1:** The transformational leadership behaviors of coaches of high-level university football teams have a significant negative impact on athlete turnover intention.

Transformational Leadership and the Coach-Athlete Relationship

A favorable superior-subordinate relationship, mutual trust, and sincere collaboration between leaders and employees form the foundation of effective organizational operations, with modern leadership research encouraging leaders to avoid overt or aggressive displays of power and follow "human-oriented" principles instead (Ma & Qu, 2007). Similarly, although coaches of high-level university sports teams in China retain the official right to manage (i.e., control) their team, the mentoring relationship that has long been established in this industry downplays the concepts of supervision and control, and instead encourages caring instruction.

Bass et al. (1999) determined that transformational leadership consists of four dimensional structures: charisma, inspirational motivation, intellectual stimulation, and individualized consideration. Of these four dimensional structures, inspirational motivation, intellectual stimulation, and individualized consideration all require a connection with subordinate employees to be realized (Avolio, Bass & Jung, 1999). Similarly, among high-level university football teams in China, coaches' inspirational motivation, intellectual stimulation, and individualized consideration must be embodied in their general interactions related to training and life. Therefore, the following hypothesis was proposed:

H2: The transformational leadership behaviors of coaches of high-level university football teams have a positive impact on the coach-athlete relationship.

Mediating Effect of the Coach-Athlete Relationship

In general, a more favorable superior-subordinate relationship (i.e., a more satisfactory relationship based on the revelation of true feelings) is associated with employees being more likely to display consistency and tacit understanding with their managers in work and life (Wu et al., 2016), and being more appreciative of managers' leadership styles; it is also associated with managers being more likely to provide employees with guidance and assistance. A similar association can be found in university sports teams. Specifically, athletes who maintain a more favorable relationship with their coaches tend to receive more guidance and care from those coaches related to training and life, and tend to show more support and appreciation for the coaches' work and coaching style. Such a caring coach-athlete relationship also means that athletes receive more support from and feel more valued by their sports team, which typically makes them more willing to stay on the team (Ma & Qu, 2007; Wu et al., 2014). Thus, the following hypothesis was proposed:

H3: The coach-athlete relationship is negatively associated with athlete turnover intention.

In short, a favorable coach-athlete relationship can prevent the development of athlete turnover intention. Additionally, transformational leadership can establish a high-quality superior-subordinate relationship through managers' common pursuit (with employees) of self-value and growth, which positively influences employee work results. A high-quality superior-subordinate relationship is indicated by trust, admiration, and respect from leaders (who also deliver the results expected of their subordinates) and trust, loyalty, hard work, and high performance from subordinates (Jiang & Yang, 2014). Therefore, the superior-subordinate relationship plays a critical role in reducing employee turnover intention via transformational leadership. Similarly for sports teams, coaches' transformational leadership behaviors can effectively promote the relationship between them and their athletes, and a favorable coach-athlete relationship can encourage athletes to train hard and compete, thereby reducing turnover intention. Therefore, the following hypothesis was proposed:

H4: Transformational leadership significantly reduces athlete turnover intention through the mediating effects of the coach-athlete relationship.

The following theoretical model in **Figure 1** was proposed based on the aforementioned theoretical analyses and hypotheses:

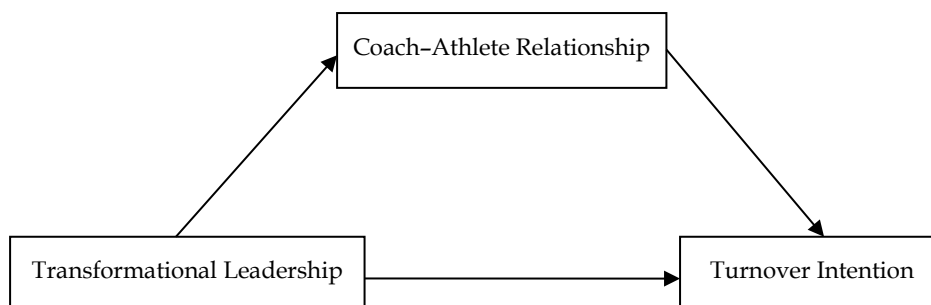

Figure 1. Research Model

RESEARCH METHOD

Sampling and Participants

The main research respondents for this study were high-level university football teams in China. Cluster sampling was conducted during the national university football league 2016 season using "team" as the sampling unit; specifically, 225 high-level football athletes from nine universities that recruit high-level athletes (Sichuan University, Southwestern University of Finance and Economics, Nanchang University, Central South University, Nanjing University of Aeronautics and Astronautics, Chongqing University, Tongji University, South China University of Technology, and City University of Hong Kong) were selected as respondents. All of the respondents were male, and the group comprised 62 freshmen, 49 sophomores, 41 juniors, 27 seniors, and 3 postgraduates. A total of 64 of the respondents were first-level athletes who passed the independent entrance examination for their university, 50 were second-level athletes who passed the National Higher Education Entrance Examination with a score of 65% (as required by local second tier universities), 47 were second-level athletes who passed the National Higher Education Entrance Examination with a score as required by local second tier universities, and 21 were ordinary students who directly enrolled in their universities through the National Higher Education Entrance Examination.

A total of 225 questionnaires were distributed and 220 were returned, yielding a questionnaire return rate of 97.78%. Among those returned, 38 invalid questionnaires were excluded, leaving 182 questionnaires that could be used for data analysis. Thus, the questionnaire validity rate was 82.72%.

Variable Measurement

The 22-item transformational leadership behavior questionnaire was originally compiled by Herold et al. (2008) according to research by Rubin et al. (2005). All items in the questionnaire began with "The head coach will....."; examples of the questions include "The head coach will outline future blueprints that are interesting for us," "The head coach will encourage us to become part of the team," and "The head coach's coaching style will consider our personal needs." All items were answered using a 5-point Likert scale.

The coach-athlete relationship scale in this study referenced the subordinate-supervisor guanxi (SSG) theory developed by Wong et al. (2010). The corresponds with most domestic and foreign studies on the superior-subordinate relationship, which have mainly adopted one of two theories: the Western leader-member exchange (LMX) theory, which is a branch of the management leadership theories that effectively explains the impacts that superiors have on subordinates; and the SSG theory in China (Wu et al., 2014; Wu et al., 2016). Notably, the coach-athlete relationship in China has begun to transform from a mentoring relationship to a contractual relationship, especially in the case of highly professional team sports such as football and basketball, wherein a coach's role regarding the entire team has been modified from a "teacher" to a "manager." However, the features of this contractual relationship between coaches and athletes remain unclear due to the overall situation in China, with no obvious indication of vertical duality or social exchange. Nevertheless, the continuing mentoring relationship that exists between coaches and athletes in team sports (sometimes beginning in athletes' youth), together with the influence of traditional Chinese culture, means that the coach-athlete relationship in China generally displays obvious characteristics of SSG. In addition, numerous studies have verified that the coach-athlete relationship in China is actually one type of Chinese-style interpersonal and communication relationships, for which the SSG theory is suitable for analyzing (Frey, Czech, Kennt & Johnson, 2006). Thus, the SSG theory was selected for this study. The scale consisted of eight items, with questions such as "After training and competitions, I interact frequently with my coach" and "After training and competitions, I share almost the same interests and hobbies with my coach."

Finally, the scale compiled by Arnold et al. (1999) was adopted to measure turnover intention. This scale consists of three items, and includes questions such as "I often think of quitting the team."

Table 1. Reliability Analysis and Correlation Analysis

Variable	Items	α	Transformational Leadership	Coach–Athlete Relationship	Turnover Intention
Transformational Leadership	22	0.96	1		
Coach–Athlete Relationship	8	0.85	0.44**	1	
Turnover Intention	3	0.65	-0.40**	-0.25*	1

RESULTS AND ANALYSIS

Reliability, Validity, and Correlation Analyses

All of the scales utilized in this study were subjected to Cronbach's α coefficient testing using the statistical analysis software SPSS version 17.0. The results indicated that the Cronbach's α coefficients for transformational leadership, the coach–athlete relationship, and turnover intention were 0.96, 0.85, and 0.65, all of which were greater than 0.60 and thus reliable (see **Table 1**). Specifically, the correlation coefficient between transformational leadership and the coach–athlete relationship, and between transformational leadership and turnover intention, was ($r = 0.44, p < .01$) and ($r = -0.40, p < .01$), respectively, whereas the correlation coefficient between the coach–athlete relationship and turnover intention was ($r = 0.25, p < .05$). These results indicate that the synchronous change between variables was statistically significant and should be further analyzed to verify the causal relationship between them, providing a basis on which to test the hypotheses.

Next, the validity of the scales was tested using factor analysis, which revealed that the factor loadings for transformational leadership, the coach–athlete relationship, and turnover intention were all greater than 0.50; moreover, the removal of any one question item did not cause a significant increase in the reliability of the scale. In addition, the cumulative variance explained for the three scales was 70.28%, 66.13%, and 59.46%, respectively. Therefore, all three scales were considered to possess satisfactory validity.

Common Method Variance Analysis

Common method variance (CMV) is a systematic error, also known as an artificial covariance between the predicted variable and criterion variable caused by the same data source or scorer, the same measurement environment, item context, or item characteristics. The partial correlation analysis developed by Podsakoff et al. (2003) was used to examine whether this study contained a significant CMV problem. The results showed that the correlation coefficients for each of transformational leadership, the coach–athlete relationship, and turnover intention were significant (i.e., -0.634, 0.44, and -0.41, respectively), indicating that CMV was an insignificant problem in this study.

Regression Analysis

In this study, variables such as athletes' grades, field positions, and admissions were set as the control variables, and a linear regression equation was established between transformational leadership, the coach–athlete relationship, and turnover intention. The relationship between transformational leadership, the coach–athlete relationship, and turnover intention was then determined by examining the significance of β .

Main Effects Analysis

Table 2 shows that in the regression equation of the dependent variables in relation to the independent variables, university football coaches' transformational leadership had a negative effect on athletes' turnover intention ($\beta = -0.303, p < .01$) and a positive effect on the coach–athlete relationship ($\beta = 0.392, p < .01$). Hence, Hypotheses 1 and 2 were supported. The results suggest that coaches' transformational leadership behaviors can reduce athlete turnover intention and facilitate the relationship between athletes and coaches.

Table 2. Analysis of Main Effects

Dependent variable		Turnover intention		Coach-athlete relationship	
		M1	M2	M3	M4
Control Variable	Grade	-0.047	-0.052	-0.047	-0.054
	Position	0.056	0.070	0.056	0.024
	Ways of enroll	-0.072	-0.045	-0.072	-0.019
Independent Variable	Transformational leadership		-0.303**		0.392**
F		1.723	10.079**	1.723	11.402**
R ²		0.028	0.186	0.028	0.205
ΔR ²		0.012	0.167**	0.012	0.187**

Table 3. Analysis of Mediated Effects

Dependent variable		Turnover intention		
		M5	M6	M7
Control Variable	Grade	-0.047	-0.052	-0.058
	Position	0.056	0.070	0.039
	Ways of enroll	-0.072	-0.045	0.003
Independent Variable	Transformational leadership		-0.303**	-0.285**
Mediated Variable	Coach-athlete relationship			-0.370**
F		1.723	10.079**	18.358**
R ²		0.028	0.186	0.343
ΔR ²		0.012	0.167**	0.324**

Mediating Effect

As revealed in **Table 3**, the regression equation for the dependent variables in relation to the independent variables indicated that the impact of grades, field positions, and admissions on athlete turnover intention were insignificant. After introducing transformational leadership, it was determined that coaches' transformational leadership behaviors had a negative effect on athletes' turnover intention ($\beta = -0.303$, $p < .01$). Subsequently, the coach-athlete relationship was introduced and the effects of both transformational leadership and the coach-athlete relationship were examined, with the coach-athlete relationship significantly negatively affecting athletes' turnover intention ($\beta = -0.370$, $p < .01$). Thus, Hypothesis 3 was supported. Further analysis indicated that transformational leadership still had a significant impact on turnover intention ($\beta = -0.285$, $p < .01$) after the coach-athlete relationship had been added, although the β coefficient was significantly reduced. Nevertheless, the condition of partial mediation was met, illustrating that the predictive effect of transformational leadership on turnover intention could be realized through the coach-athlete relationship. Hence, Hypothesis 4 was supported.

DISCUSSION

Effect of the Transformational Leadership Behavior of Coaches on Athlete Turnover Intention

The research results indicated that the transformational leadership behaviors of high-level university football team coaches have a negative effect on athlete turnover intention; in other words, coaches' transformational leadership behaviors reduce the development of athletes' desires and intent to leave a team. As was discussed earlier, the probability of high-level university football players actually leaving their teams is small because of their identities as high-level university athletes and students. Indeed, their main purpose for entering university is to receive a high education and obtain the corresponding degree, and their studies would be greatly affected if they left their respective sports teams. However, simply because athletes do not actually leave is not a guarantee that they will not be inclined to leave. Despite studies maintaining that the impact of turnover intention on employee

performance is influenced by various factors (Allen, Weeks & Moffitt, 2005), it is undeniable that athletes' turnover tendency reflects dissatisfaction with the status quo. Such dissatisfaction may originate from individuals, organizations, work characteristics, or environments, and may cause athletes to slack off or vent their discontent during training and competitions. In particular, in team sports such as football, personal problems may directly affect the unity and teamwork of a team. According to the four dimensions of transformational leadership proposed by Bass (1995), athletes can develop trust toward organizations through their coaches' inspirational motivation and individualized consideration. Coaches with transformational leadership are conducive to athletes' development of trust and tend to strive for fairness in the organization, which enhances athlete identification, involvement, and loyalty to the organization; reduces turnover intention; promotes teamwork among the team; and facilitates improved performance.

Effect of the Transformational Leadership Behavior of Coaches on the Coach–Athlete Relationship

Gerstner and Day (1997) conducted the first theoretical study on the conceptual and empirical relationships between transformational leadership and the superior–subordinate relationship, although the superior–subordinate relationship theory used in their research was based on the Western-contextualized LMX theory. In the present study, it was discovered that transformational leadership behavior was significantly related to the Chinese-contextualized SSG theory, with the results indicating that the transformational leadership behaviors of high-level university football team coaches had a significant positive impact on the coach–athlete relationship. In other words, coaches' transformational leadership behaviors have a positive effect on the relationship between coaches and their athletes, facilitating the development of a relationship between them. Transformational leadership changes the relationship that is established by transactional leadership (wherein subordination is based on contracts and transactions), with managers offering more support, care, and affection (including that in nonworking contexts) to employees. In university sports teams in China, coaches with transformational leadership characteristics can influence athletes through personal charisma, intellectual stimulation, and some compelling behaviors; these factors prompt athletes to identify with their coaches' behaviors and develop respect and trust for their coaches, thus strengthening the coach–athlete relationship overall.

Impact of the Transformational Leadership Behavior of Coaches on Athlete Turnover Intention Mediated through the Coach–Athlete Relationship

Superior–subordinate relationships are often viewed as the impact mechanism of transformational leadership on employees' psychological characteristics; that is, a superior–subordinate relationship is the mediating variable for the influence of transformational leadership on employees (Wu et al., 2014; Wu et al., 2016). The present study similarly verified this phenomenon in a sports context, revealing that coaches' transformational leadership behaviors affect athletes' turnover intention through the coach–athlete relationship. Notably, the coach–athlete relationship had a mediating effect between transformational leadership and turnover intention because the "charisma" dimension in the transformational leadership theory refers to a coach's personal characteristics, which always exist without the need to develop a connection with athletes. Therefore, unlike the other three dimensions, the impact of this particular dimension on athletes does not need to be realized through the coach–athlete relationship.

CONCLUSION

China's high-level university football teams are a crucial component for the development of China's campus football industry. These teams become the top reserve talent training channels for campus football, as well as one of the crucial channels for cultivating China's high-level football players. At present, the various management and training systems utilized for high-level football teams in China are still incomplete, and their essential roles in the cultivation of China's sports talents have yet to be demonstrated. Nevertheless, it is established that coaches play a crucial multirole in high-level football teams, during which their personal capacity and leadership style significantly affect high-level football teams. Through the present study, it was discovered that the

transformational leadership behaviors of China's high-level university football team coaches have a significant impact on athlete turnover intention and the coach-athlete relationship; specifically, they reduce athlete turnover intention and enhance the relationship between coaches and athletes. Moreover, the impact of coaches' transformational leadership behaviors on athlete turnover intention is realized through the coach-athlete relationship, which exhibits a mediating effect on the process. Therefore, high-level university football team coaches should focus on athletes' personal development, encourage athletes to demonstrate their personal talents, and demonstrate humanistic care toward athletes' lives and learnings in order to continually improve their relationship with the athletes, minimize the athletes' turnover intention, and facilitate the development of united and harmonious sports teams.

ACKNOWLEDGEMENT

This study is supported by "The Fundamental Research Funds for the Central Universities".

REFERENCES

- Allen, D. G., Weeks, K. P., & Moffitt, K. R. (2005). Turnover intentions and voluntary turnover: the moderating roles of self-monitoring, locus of control, proactive personality, and risk aversion. *Journal of Applied Psychology, 90*(5), 980-990.
- Arnold, J., & Davey, K. M. (1999). Graduates' Work Experiences as Predictors of Organisational Commitment, Intention to Leave, and Turnover: Which Experiences Really Matter? *Applied Psychology: An International Review, 48*(2), 211-238.
- Avolio, B. J., Bass, B. M., & Dong, I. J. (2011). Re-examining the components of transformational and transactional leadership using the multifactor leadership. *Journal of Occupational & Organizational Psychology, 72*(4), 441-462.
- Bass, B. M. (1995). Theory of transformational leadership redux. *The Leadership Quarterly, 6*(4), 463-478.
- Bass, B. M. (1999). Two Decades of Research and Development in Transformational Leadership. *European Journal of Work and Organizational Psychology, 8*(1), 9-32.
- Bass, B. M., & Avolio, B. J. (1990). Developing Transformational Leadership: 1992 and Beyond. *Journal of European Industrial Training, 14*(5), 21-27.
- Bowen, D., & Siehl, C. (1997). The future of human resource management: March and Simon (1958) revisited. *Human Resource Management, 36*(1), 57-63.
- Cronin, L. D., Arthur, C. A., Hardy, J., & Callow, N. (2015). Transformational leadership and task cohesion in sport: the mediating role of inside sacrifice. *Journal of Sport & Exercise Psychology, 37*(1), 23-36.
- Doherty, A. J., & Danylchuk, K. E. (1996). Transformational and Transactional Leadership in Interuniversity Athletics Management. *Journal of Sport Management, 10*(3), 292-309.
- Donohue, B., Miller, A., Crammer, L., Cross, C., & Covassin, T. (2007). A Standardized Method of Assessing Sport Specific Problems in the Relationships of Athletes with Their Coaches, Teammates, Family, and Peers. *Journal of Sport Behavior, 30*(4), 375-397.
- Frey, M., Czech, D. R., Kent, R. G., & Johnson, M. (2006). An Exploration of Female Athletes' Experiences and Perceptions of Male and Female Coaches. *Sport Journal, 9*(4), 23-27.
- Gerstner, C. R., & Day, D. V. (1997). Meta-Analytic Review of Leader-Member Exchange Theory: Correlates and Construct Issues. *Journal of Applied Psychology, 82*(6), 827-844.
- Geyer, A. L. J., & Steyrer, J. M. (1998). Transformational leadership and objective performance in bank. *Applied Psychology, 47*(3), 397-420.
- Graen, G. B., & Uhl-Bien, M. (1995). Relationship-based approach to leadership: development of leader-member exchange (lmx) theory of leadership over 25 years: applying a multi-level multi-domain perspective. *Leadership Quarterly, 6*(2), 219-247.
- Hampson, R., & Jowett, S. (2014). Effects of coach leadership and coach-athlete relationship on collective efficacy. *Scandinavian Journal of Medicine & Science In Sports, 24*(2), 454-460.

- Herold, D. M., Fedor, D. B., Caldwell, S., & Liu, Y. (2008). The effects of transformational and change leadership on employees' commitment to a change: a multilevel study. *The Journal of Applied Psychology, 93*(2), 346-357.
- Hom, P. W., Mitchell, T. R., Lee, T. W., & Griffeth, R. W. (2012). Reviewing employee turnover: focusing on proximal withdrawal states and an expanded criterion. *Psychological Bulletin, 138*(5), 831-858.
- Hu, T., & Yao, L. (2015). Development path of school sports training in contemporary China. *Journal of Beijing sports university, 38*(12), 102-109.
- Jiang, J., & Yang, B. Y. (2014). Leader-member exchange, intrinsic motivation and employees creativity: the moderating role of the job variety. *Science of Science & Management of S & T., (1)*, 165-172.
- Jung, D. I., & Sosik, J. J. (2002). Transformational Leadership in Work Groups: The Role of Empowerment, Cohesiveness, and Collective-Efficacy on Perceived Group Performance. *Small Group Research, 33*(3), 313.
- Kim, S. Y., & Fernandez, S. (2017). Employee empowerment and turnover intention in the US federal bureaucracy. *The American Review of Public Administration, 47*(1), 4-22.
- Ma, L., & Qu, Q. (2007). The Possible Seamy Side: the Impact of the Exchange and the Relationship between Leaders and Members on the Organizational Justice. *Management World, (11)*, 87-95.
- Mobley, W. H., Griffeth, R. W., Hand, H. H., & Meglino, B. M. (1979). Review and conceptual analysis of the employee turnover process. *Psychological Bulletin, 86*(3), 493-522.
- Myers, S. A. (2017). The instructor-student relationship as an alternative form of superior-subordinate relationship. *Communication Education, 66*(1), 110-112.
- Pharion, J. L. (2014). *Transformational leadership in coaching*. The Dissertation of Ashland University.
- Podsakoff, P. M., MacKenzie, S. B., Lee, J., & Podsakoff, N. P. (2003). Common method biases in behavioral research: a critical review of the literature and recommended remedies. *The Journal of Applied Psychology, 88*(5), 879-903.
- Price, M. S., & Weiss, M. R. (2013). Relationships among Coach Leadership, Peer Leadership, and Adolescent Athletes' Psychosocial and Team Outcomes: A Test of Transformational Leadership Theory. *Journal of Applied Sport Psychology, 25*(2), 265-279.
- Pruijn, G. H. J. (1995). The relationship of transactional and transformational leadership to the organizational effectiveness of Dutch national sport organizations. *European Journal for Sport Management, (72)*, 72-87.
- Redmond, V., Jameson, J. K., & Binder, A. R. (2016). How Superior-Subordinate Relationship Quality and Conflict Management Styles Influence an Employee's Use of Upward Dissent Tactics. *Negotiation and Conflict Management Research, 9*(2), 158-176.
- Rubin, R. S., Munz, D. C., & Bommer, W. H. (2005). Leading from within: The effects of emotion recognition and personality on transformational leadership behavior. *Academy of Management Journal, (48)*, 845- 858.
- Schmitt, A., Den Hartog, D. N., & Belschak, F. D. (2016). Transformational leadership and proactive work behaviour: A moderated mediation model including work engagement and job strain. *Journal of Occupational and Organizational Psychology, 89*(3), 588-610.
- Turner, B., & Pack, S. (2013). Multidimensional commitment of intercollegiate student-athletes: its effects on intention to leave and satisfaction. *Journal for the Study of Sports & Athletes in Education, (7)*, 141-156.
- Wallace, M., & Weese, W. J. (1995). Leadership, Organizational Culture, and Job Satisfaction in Canadian YMCA Organizations. *Journal of Sport Management, 9*(2), 182-193.
- Wang, H. J., Demerouti, E., & Le Blanc, P. (2017). Transformational leadership, adaptability, and job crafting: The moderating role of organizational identification. *Journal of Vocational Behavior, 100*, 185-195.
- Wong Y. T., Wong S. H., Wong Y. W. (2010). A study of subordinate-supervisor guanxi in Chinese joint ventures. *The International Journal of Human Resource Management, 21*(12), 142-2155.
- Wu, T. J., & Tai, Y. N. (2016). Effects of multimedia information technology integrated multi-sensory instruction on students' learning motivation and outcome. *EURASIA Journal of Mathematics, Science and Technology Education, 12*(4), 1065-1074.
- Wu, T. J., Tsai, H. T., & Tai, Y. N. (2016). Would corporate social responsibility affect consumers' attitudes towards brand and purchase behavior? Buyer-seller guanxi as the moderator. *Revista de Cercetare si Interventie Sociala, 53*, 272-287.

- Wu, T. J., Tsai, H. T., & Yeh, S. P. (2014). The role of manager's locus of control between perceived guanxi and leadership behavior in family business. *Revista Internacional de Sociologia*, 72(EXTRA2), 87-104.
- Xu, C. X. (2014). Review on the progress of employee turnover. *Management and Administration*, (4), 124-128.
- Yan, S., Zhu, Z. Q., & Li, S. B. (2017). Short-track speeding skating coaches' transformational leadership behaviors and athletes' role involvement: the mediation effect of the trust on coaches. *Journal of Guangzhou Sport University*, 37(1), 28-33.
- Yui-Tim, W., Shiu-Ho, W., & Yui-Woon, W. (2010). A study of subordinate-supervisor guanxi in Chinese joint ventures. *International Journal of Human Resource Management*, 21(12), 2142-2155.
- Zhang, Y., Gang, Y., & Zhang, S. (2010). Influences of sport industry manager's communication competency on employees' turnover intention. *Journal of Shenyang Sport University*, 2, 60-62.

<http://www.ejmste.com>



<http://www.ejmste.com>



<https://twitter.com/ejmste>



<https://www.facebook.com/ejmste>



<http://modestum.co.uk/>



publications@modestum.co.uk

EURASIA Journal of Mathematics, Science and Technology Education



<https://twitter.com/ejmste>
<https://www.facebook.com/ejmste>
<http://modestum.co.uk/>



<http://www.ejmste.com>

e-ISSN: 1305-8223
ISSN: 1305-8215